

INSTALLATION MANUAL

AIR CONDITIONER

Please read this installation manual completely before installing the product. Installation work must be performed in accordance with the national wiring standards by authorized personnel only. Please retain this installation manual for future reference after reading it thoroughly.

4-WAY CEILING CASSETTE



MFL61971220
Rev.00_013119

<http://www.lghvac.com>
www.lg.com

Copyright © 2013 - 2019 LG Electronics Inc. All Rights Reserved.

TIPS FOR SAVING ENERGY

Here are some tips that will help you minimize the power consumption when you use the air conditioner. You can use your air conditioner more efficiently by referring to the instructions below:

- Do not cool excessively indoors. This may be harmful for your health and may consume more electricity.
- Block sunlight with blinds or curtains while you are operating the air conditioner.
- Keep doors or windows closed tightly while you are operating the air conditioner.
- Adjust the direction of the air flow vertically or horizontally to circulate indoor air.
- Speed up the fan to cool or warm indoor air quickly, in a short period of time.
- Open windows regularly for ventilation as the indoor air quality may deteriorate if the air conditioner is used for many hours.
- Clean the air filter once every 2 weeks. Dust and impurities collected in the air filter may block the air flow or weaken the cooling / dehumidifying functions.

For your records

Staple your receipt to this page in case you need it to prove the date of purchase or for warranty purposes. Write the model number and the serial number here:

Model number : _____

Serial number : _____

You can find them on a label on the side of each unit.

Dealer's name : _____

Date of purchase : _____

IMPORTANT SAFETY INSTRUCTIONS

READ ALL INSTRUCTIONS BEFORE USING THE APPLIANCE.

Always comply with the following precautions to avoid dangerous situations and ensure peak performance of your product.

WARNING

It can result in serious injury or death when the directions are ignored.

CAUTION

It can result in minor injury or product damage when the directions are ignored.

WARNING

- Installation or repairs made by unqualified persons can result in hazards to you and others.
- Installation of all field wiring and components **MUST** conform with local building codes or, in the absence of local codes, with the National Electrical Code 70 and the National Building Construction and Safety Code or Canadian Electrical code and National Building Code of Canada.
- The information contained in the manual is intended for use by a qualified service technician familiar with safety procedures and equipped with the proper tools and test instruments.
- Failure to carefully read and follow all instructions in this manual can result in equipment malfunction, property damage, personal injury and/or death.

Installation

- Always perform grounding.
 - Otherwise, it may cause electrical shock.
- Don't use a power cord, a plug or a loose socket which is damaged.
 - Otherwise, it may cause a fire or electrical shock.
- For installation of the product, always contact the service center or a professional installation agency.
 - Otherwise, it may cause a fire, electrical shock, explosion or injury.
- Securely attach the electrical part cover to the indoor unit and the service panel to the outdoor unit.
 - If the electrical part cover of the indoor unit and the service panel of the outdoor unit are not attached securely, it could result in a fire or electric shock due to dust, water, etc.
- Always install an air leakage breaker and a dedicated switching board.
 - No installation may cause a fire and electrical shock.
- Do not keep or use flammable gases or combustibles near the air conditioner.
 - Otherwise, it may cause a fire or the failure of product.
- Ensure that an installation frame of the outdoor unit is not damaged due to use for a long time.
 - It may cause injury or an accident.
- Do not disassemble or repair the product randomly.
 - It will cause a fire or electrical shock.
- Do not install the product at a place that there is concern of falling down.
 - Otherwise, it may result in personal injury.
- Use caution when unpacking and installing.
 - Sharp edges may cause injury.
- Use a vacuum pump or Inert (nitrogen) gas when doing leakage test or air purge. Do not compress air or Oxygen and Do not use Flammable gases. Otherwise, it may cause fire or explosion. There is the risk of death, injury, fire or explosion.

Operation

- Do not share the outlet with other appliances.
 - It will cause an electric shock or a fire due to heat generation.
- Do not use the damaged power cord.
 - Otherwise, it may cause a fire or electrical shock.

- Do not modify or extend the power cord randomly.
 - Otherwise, it may cause a fire or electrical shock.
- Take care so that the power cord may not be pulled during operation.
 - Otherwise, it may cause a fire or electrical shock.
- Unplug the unit if strange sounds, smell, or smoke comes from it.
 - Otherwise, it may cause electrical shock or a fire.
- Keep the flames away.
 - Otherwise, it may cause a fire.
- Take the power plug out if necessary, holding the head of the plug and do not touch it with wet hands.
 - Otherwise, it may cause a fire or electrical shock.
- Do not use the power cord near the heating tools.
 - Otherwise, it may cause a fire and electrical shock.
- Do not open the suction inlet of the indoor/outdoor unit during operation.
 - Otherwise, it may electrical shock and failure.
- Do not allow water to run into electrical parts.
 - Otherwise, it may cause the failure of machine or electrical shock.
- Hold the plug by the head when taking it out.
 - It may cause electric shock and damage.
- Never touch the metal parts of the unit when removing the filter.
 - They are sharp and may cause injury.
- Do not step on the indoor/outdoor unit and do not put anything on it.
 - It may cause an injury through dropping of the unit or falling down.
- Do not place a heavy object on the power cord.
 - Otherwise, it may cause a fire or electrical shock.
- When the product is submerged into water, always contact the service center.
 - Otherwise, it may cause a fire or electrical shock.
- Take care so that children may not step on the outdoor unit.
 - Otherwise, children may be seriously injured due to falling down.

CAUTION

Installation

- Install the drain hose to ensure that drain can be securely done.
 - Otherwise, it may cause water leakage.
- Install the product so that the noise or hot wind from the outdoor unit may not cause any damage to the neighbors.
 - Otherwise, it may cause dispute with the neighbors.
- Always inspect gas leakage after the installation and repair of product.
 - Otherwise, it may cause the failure of product.
- Keep level parallel in installing the product.
 - Otherwise, it may cause vibration or water leakage.

Operation

- Avoid excessive cooling and perform ventilation sometimes.
 - Otherwise, it may do harm to your health.
- Use a soft cloth to clean. Do not use wax, thinner, or a strong detergent.
 - The appearance of the air conditioner may deteriorate, change color, or develop surface flaws.
- Do not use an appliance for special purposes such as preserving animals vegetables, precision machine, or art articles.
 - Otherwise, it may damage your properties.
- Do not place obstacles around the flow inlet or outlet.
 - Otherwise, it may cause the failure of appliance or an accident.

TABLE OF CONTENTS

6 INSTALLATION PLACES

7 THE INDOOR UNIT INSTALLATION

- 8 Indoor Unit Drain Piping
- 9 Wiring Connection
- 11 Flaring work
- 12 Connection of piping

13 INSTALLATION OF DECORATIVE PANEL(Accessory)

15 TEST RUNNING

16 INSTALLATION INSTRUCTIONS

- 16 Installer Setting - How to enter installer setting mode
- 17 Installer Setting - Installer Setting Code Table
- 18 Installer Setting - Setting Address of Central Control
- 18 Installer Setting - Checking Address of Central Control

INSTALLATION PLACES

- There should not be any heat source or steam near the unit.
- There should not be any obstacles to prevent the air circulation.
- A place where air circulation in the room will be good.
- A place where drainage can be easily obtained.
- A place where noise prevention is taken into consideration.
- Do not install the unit near the door way.
- Ensure the spaces indicated by arrows from the wall, ceiling, or other obstacles.
- The indoor unit must keep the maintenance space.

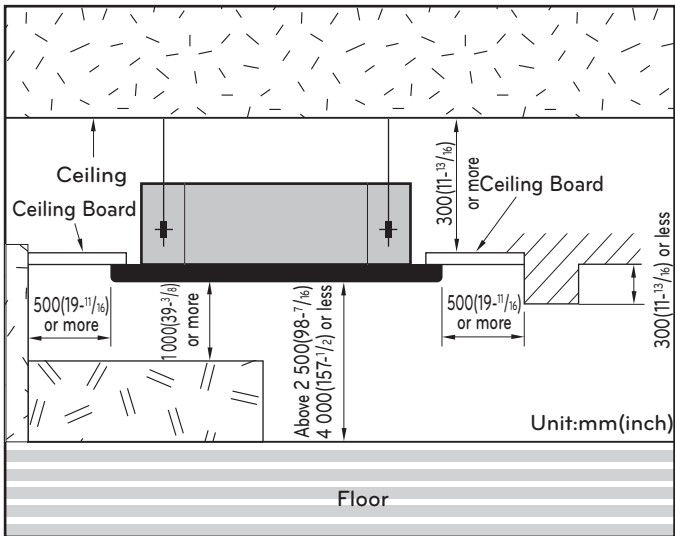

THE INDOOR UNIT INSTALLATION

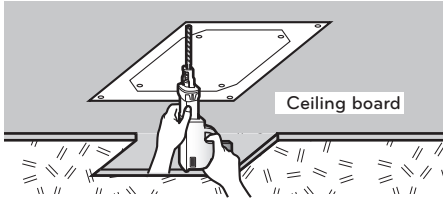
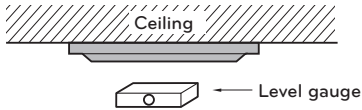

- Select and mark the position for fixing bolts and piping hole.
- Decide the position for fixing bolts slightly tilted to the drain direction after considering the direction of drain hose.
- Drill the hole for anchor bolt on the wall.
- When using cardboard on the bottom of packaging, use after separating installation paper from bottom of the product packaging using back of a knife as shown in the picture (TM/TN/TP)

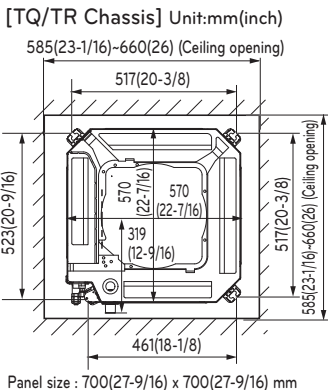
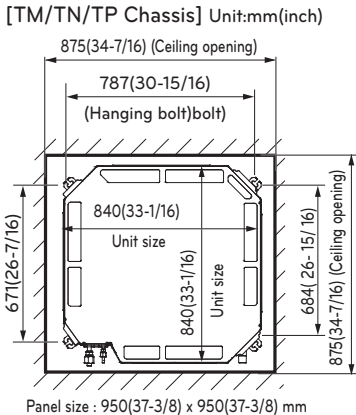
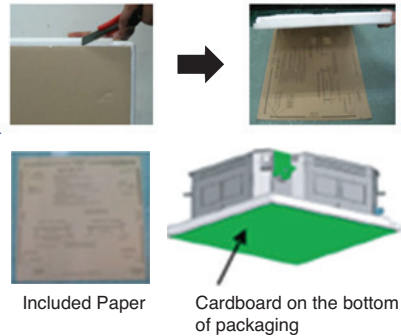

CAUTION

- This air-conditioner uses a drain pump.
- Install the unit horizontally using a level gauge.
- During the installation, care should be taken not to damage electric wires.

NOTE

Avoid the following installation location.

- Such places as restaurants and kitchen where considerable amount of oil steam and flour is generated. These may cause heat exchange efficiency reduction, or water drops, drain pump mal-function. In these cases, take the following actions;
 - Make sure that ventilation fan is enough to cover all noxious gases from this place.
 - Ensure enough distance from the cooking room to install the air conditioner in such a place where it may not suck oily steam.

8 THE INDOOR UNIT INSTALLATION

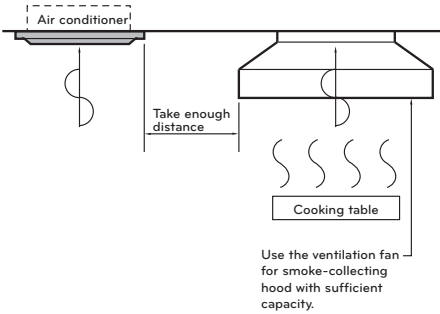

- 2 Avoid installing air conditioner in such places where cooking oil or iron powder is generated.
- 3 Avoid places where inflammable gas is generated.
- 4 Avoid place where noxious gas is generated.
- 5 Avoid places near high frequency generators.

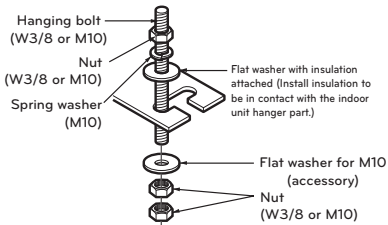

The following parts is option.

- ① Hanging Bolt - W 3/8 or M10
- ② Nut - W 3/8 or M10
- ③ Spring Washer - M10
- ④ Plate Washer - M10

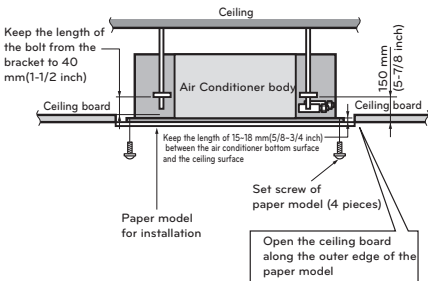

Drill the piping hole on the wall slightly tilted to the outdoor side using a $\varnothing 70$ hole-core drill.

CAUTION

Tighten the nut and bolt to prevent unit falling.

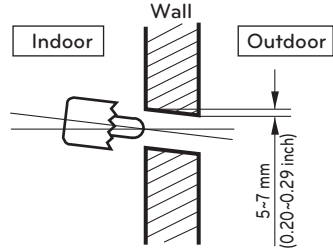

Indoor Unit Drain Piping

- Drain piping must have down-slope (1/50 to 1/100): be sure not to provide up-and-down slope to prevent reversal flow.
- During drain piping connection, be careful not to exert extra force on the drain port on the indoor unit.
- The outside diameter of the drain connection on the indoor unit is 32 mm.

Piping material: Polyvinyl chloride pipe VP-25 and pipe fittings

- Be sure to execute heat insulation on the drain piping.
- Install the drain raising pipes at a right angle to the indoor unit and no more than 300 mm from the unit.

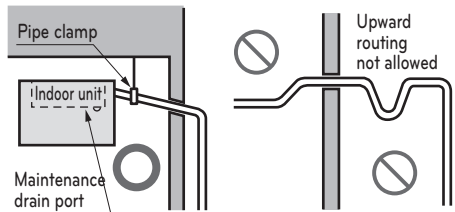

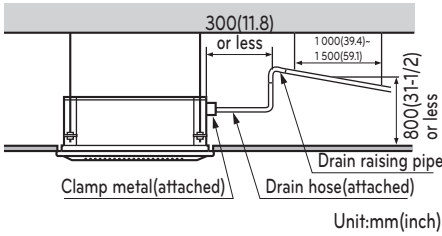

Heat insulation material: Polyethylene foam with thickness more than 8 mm(0.3 inch).

Drain test

The air conditioner uses a drain pump to drain water.

Use the following procedure to test the drain pump operation:

- Connect the main drain pipe to the exterior and leave it provisionally until the test comes to an end.
- Feed water to the flexible drain hose and check the piping for leakage.
- Be sure to check the drain pump for normal operating and noise when electrical wiring is complete.
- When the test is complete, connect the flexible drain hose to the drain port on the indoor unit.

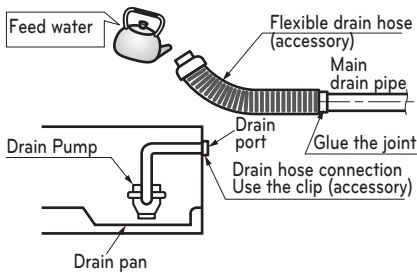

CAUTION

The supplied flexible drain hose should not be curved, neither screwed. The curved or screwed hose may cause a leakage of water.

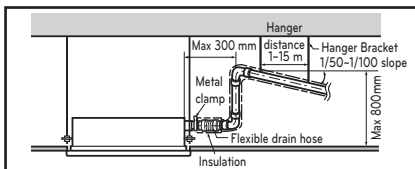

HEAT INSULATION

- Use the heat insulation material for the refrigerant piping which has an excellent heat-resistance (over 120 °C).
- Precautions in high humidity circumstance: This air conditioner has been tested according to the "KS Standard Conditions with Mist" and confirmed that there is not any default. However, if it is operated for a long time in high humid atmosphere (dew point temperature: more than 23 °C), water drops are liable to fall. In this case, add heat insulation material according to the following procedure:

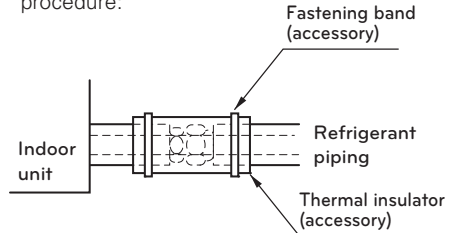

- Heat insulation material to be prepared : Adiabatic EPDM or NBR with thickness 10 to 20 mm.
- Stick glass wool on all air conditioners that are located in ceiling atmosphere.

Wiring Connection

- Open the control box cover and connect the Remote controller cord and Indoor power wires.
- Remove the control box cover for electrical connection between the indoor and outdoor unit. (Remove screws ①)
- Use the cord clamper to fix the cord.

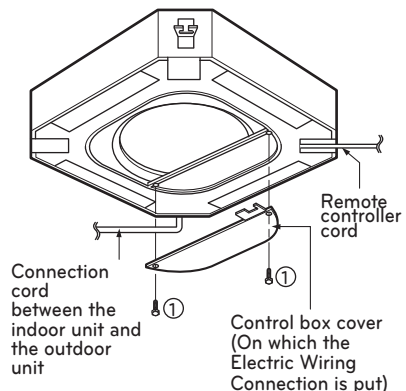

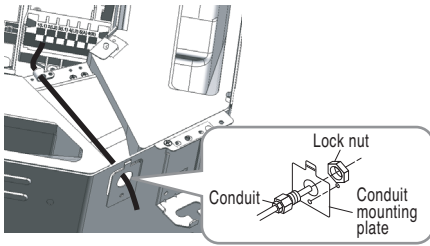

CAUTION

The connecting cable connected to the indoor and outdoor unit should be complied with the following specifications (This equipment shall be provided with a cord set complying with the national regulation).

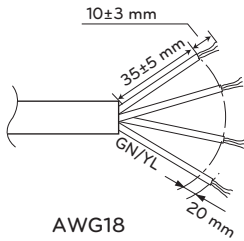

If the supply cord is damaged, it must be replaced by a special cord or assembly available from the manufacturer of its service agent.

CAUTION

The Power cord connected to the unit should be selected according to the following specifications.

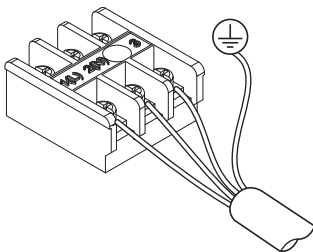

Precautions when laying power and ground wiring

Use round pressure terminals for connections to the power terminal block. When laying ground wiring, you must use round pressure terminals.

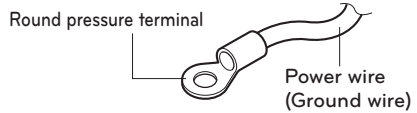

When none are available, follow the instructions below.

- Do not connect wiring of different thicknesses to the power terminal block. (Slack in the power wiring may cause abnormal heat.)
- When connecting wiring which is the same thickness, do as shown in the figure below.

Connect same thickness wiring to both sides.

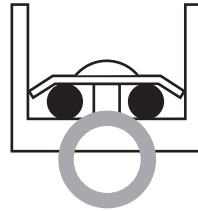

It is forbidden to connect two to one side.

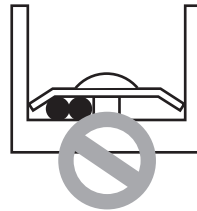

It is forbidden to connect wiring of different thicknesses.



- For wiring, use the designated power wire and connect firmly, then secure to prevent outside pressure being exerted on the terminal block.
- Use an appropriate screwdriver for tightening the terminal screws. A screwdriver with a small head will strip the head and make proper tightening impossible.
- Over-tightening the terminal screws may break them.

Flaring work

Main cause of gas leakage is defect in flaring work. Carry out correct flaring work in the following procedure.

1 Cut the pipes

- Use the accessory piping kit or the pipes purchased locally.
- Measure the distance between the indoor and the outdoor unit.
- Cut the pipes a little longer than measured distance.
- Cut the cable 1.5m(4.9ft) longer than the pipe length.

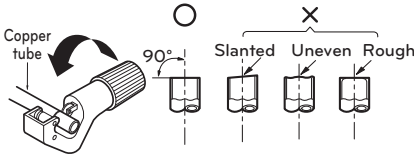

2 Burrs removal

- Completely remove all burrs from the cut cross section of pipe/tube.
- Put the end of the copper tube/pipe to downward direction as you remove burrs in order to avoid to let burrs drop in the tubing.

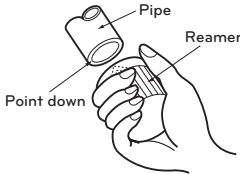

3 Putting nut on

- Remove flare nuts attached to indoor and outdoor units, than put them on pipe/tube having completed burr removal. (Not possible to put them on after flaring work)

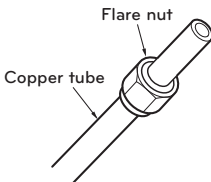

4 Flaring work

- Carry out flaring work using flaring tool as shown below.

Pipe diameter Inch (mm)	A Inch (mm)		Thickness Inch (mm)
	Wing nut type	Clutch type	
Ø1/4 (Ø6.35)	0.04~0.05 (1.1~1.3)	0~0.02 (0~0.5)	0.03 (0.7)
Ø3/8 (Ø9.52)	0.06~0.07 (1.5~1.7)		0.03 (0.8)
Ø1/2 (Ø12.7)	0.06~0.07 (1.6~1.8)		0.03 (0.8)
Ø5/8 (Ø15.88)	0.06~0.07 (1.6~1.8)		0.04 (1.0)
Ø3/4 (Ø19.05)	0.07~0.08 (1.9~2.1)		0.04 (1.0)

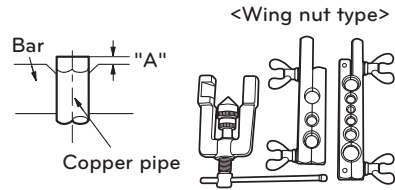

<Clutch type>

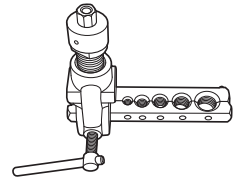

Firmly hold copper tube in a bar(or die) as indicated dimension in the table above.

5 Check

- Compare the flared work with figure.
- If flare is noted to be defective, cut off the flared section and do flaring work again.

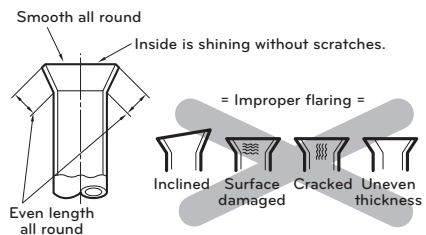

Connection of piping

Align the center of the piping and sufficiently tighten the flare nut by hand.

ODU	Capacity (kBTu/h)	Refrigerant Connections Pipe size	
		Liquid	Gas
Single Zone	18	3/8 (Ø9.52)	5/8 (Ø15.88)

* Indoor Unit (18k) includes the sockets.
 (Ø 6.35 → Ø 9.52 x 1EA, Ø 12.7 →
 Ø 15.88 x 1EA, Ø 9.52 → Ø 12.7 x 1EA)

Finally, tighten the flare nut with torque wrench until the wrench clicks.

- When tightening the flare nut with torque wrench ensure the direction for tightening follows the arrow on the wrench.

Outside diameter		Torque		
mm	inch	N·m	kgf·m	lbf·ft
Ø6.35	1/4	14~18	1.4~1.8	10~13
Ø9.52	3/8	34~42	3.5~4.3	25~31
Ø12.7	1/2	49~61	5.0~6.2	36~45
Ø15.88	5/8	69~82	7.0~8.4	51~60
Ø19.05	3/4	100~120	10.0~12.2	73~88

For Single zone

IDU

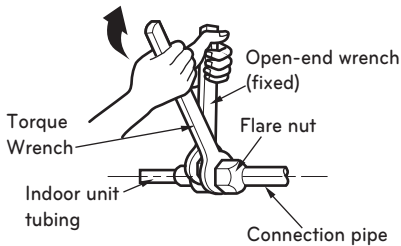
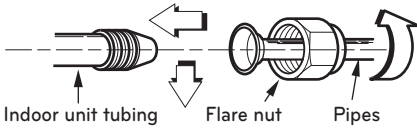
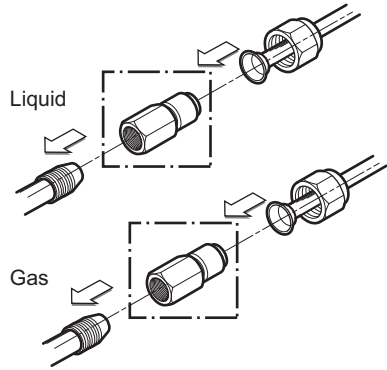

INSTALLATION OF DECORATIVE PANEL(Accessory)

The decorative panel has its installation direction.
Before installing the decorative panel, always remove the paper template.

- 1 Remove the packing and take out air inlet grille from front panel.

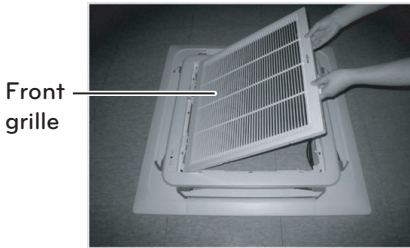

- 2 Remove the Corner covers of the panel.

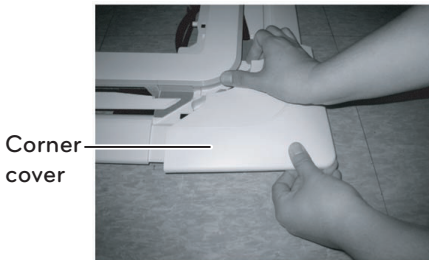

- 3 Fit the panel on the unit by inserting hooks as shown in picture.

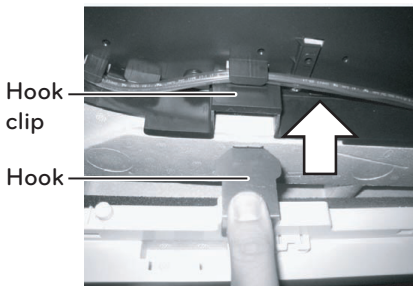

- 4 Insert two screws on diagonal corners of panel. Do not tighten the bolts completely. (The fixing bolts are included in the indoor unit box.)
 Check the alignment of panel with the ceiling. Height can be adjusted using hanging bolts as shown in picture. Insert the other two screws and tighten all screws completely.

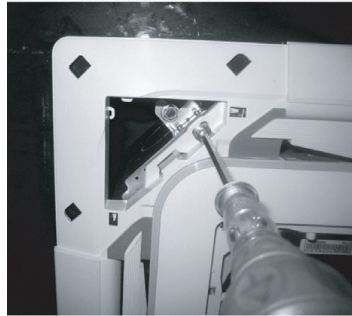

- 5 Fit the corner covers.

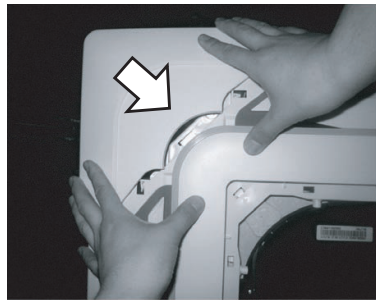

- 6 Open two screws of control panel cover.

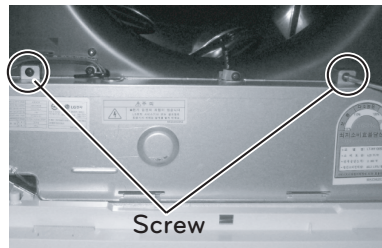

14 INSTALLATION OF DECORATIVE PANEL(ACESSORY)

- 7 Connect one display connector and two vane control connectors of front panel to indoor unit PCB.

The position marking on PCB is as:

Display connector : CN-DISPLAY

Vane control connector: CN-VANE 1,2

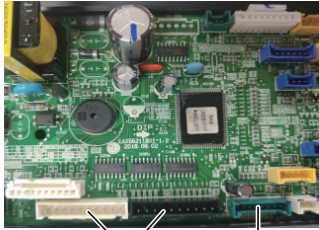

CN-DISPLAY
CN-VANE 1,2

- 8 Close the cover for control box.

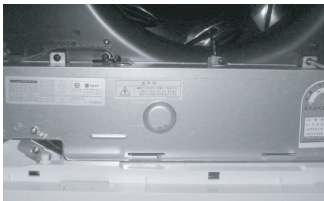

- 9 Fit the link on the panel as shown in picture. (The link is included in the front panel unit box.) (TM/TN/TP)

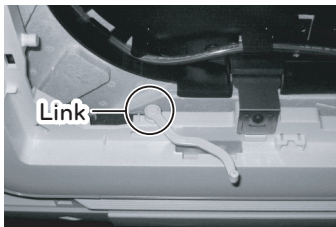

Link

- 10 Attach the other side of link on the filter guide of inlet grille. Install the air inlet grille and filter on the panel. (TM/TN/TP)

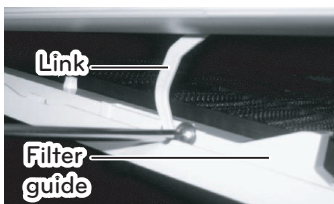

Link

Filter guide

- 11 Install the air inlet grille and Filter on the panel.

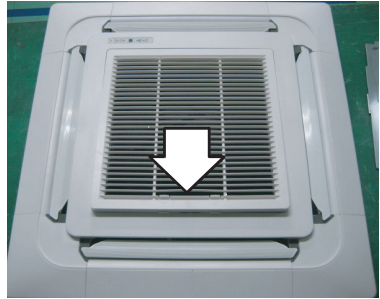

CAUTION

Install certainly the decorative panel.
Cool air leakage causes sweating. ☞
Water drops fall.

Good example

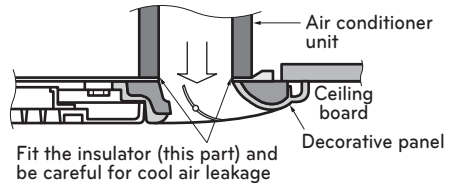

Bad example

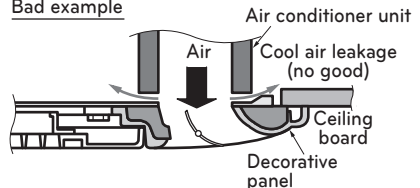

TEST RUNNING

PRECAUTIONS IN TEST RUN

- The initial power supply must provide at least 90 % of the rated voltage. Otherwise, the air conditioner should not be operated.

CAUTION

- For test run, carry out the cooling operation firstly even during heating season. If heating operation is carried out firstly, it leads to the trouble of compressor. Then attention must be paid.
- Carry out the test run more than 5 minutes without fail. (Test run will be cancelled 18 minutes later automatically)

- To cancel the test run, press any button.

CHECK THE FOLLOWING ITEMS WHEN INSTALLATION IS COMPLETED

- After completing work, be sure to measure and record trial run properties, and store measured data, etc.
- Measuring items are room temperature, outside temperature, suction temperature, blow out temperature, wind velocity, wind volume, voltage, current, presence of abnormal vibration and noise, operating pressure, piping temperature, compressive pressure.
- As to the structure and appearance, check following items.
 - * Is the circulation of air adequate?
 - * Is the draining smooth?
 - * Is the heat insulation complete (refrigerant and drain piping)?
 - * Is there any leakage of refrigerant?
 - * Is the remote controller switch operated?
 - * Is there any faulty wiring?
 - * Are not terminal screws loosened?

M4.....118 N·cm{12 kgf·cm}

M5.....196 N·cm{20 kgf·cm}

M6.....245 N·cm{25 kgf·cm}

M8.....588 N·cm{60 kgf·cm}

Connection of power supply

- Connect the power supply cord to the independent power supply. Circuit breaker is required.
- Operate the unit for 15 minutes or more.

Evaluation of the performance

- Measure the temperature of the intake and discharge air.
- Ensure the difference between the intake temperature and the discharge one is more than 8 °C (Cooling) or reversely (Heating).

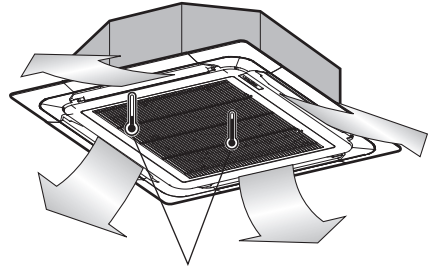

Thermometer

INSTALLATION INSTRUCTIONS

Installer Setting - How to enter installer setting mode

! CAUTION

Installer setting mode is to set the detail function of the remote controller. If the installer setting mode is not set correctly, it can cause problems to the product, user injury or property damage. This must be set by an certificated installer, and any installation or change that is carried out by a non-certificated person should be responsible for the results. In this case, free service cannot be provided.

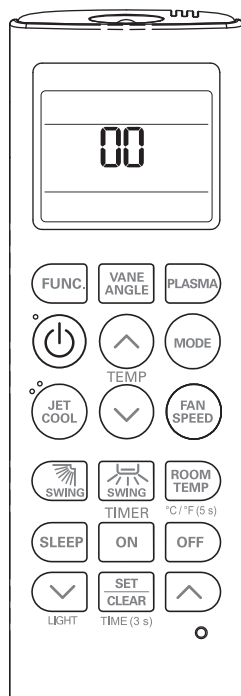

- 1 With the JET COOL button pressed, press the RESET button.
- 2 By using the TEMPERATURE SETTING button, set function code and setting value. (Please refer the Installer Setting Code Table.)
- 3 Press the ON/OFF button toward the indoor unit 1 time.
- 4 Reset the remote controller to use the general operation mode.

Refer to the Installer Setting Code Table on the next page.

Installer Setting - Installer Setting Code Table

No.	Function	Function Code	Setting Value	Remote Controller LCD
0	Mode Override	0	0 : Set to Master	0.0
			1 : Set to Slave	0.1
1	Ceiling Height Selection	1	1 : Standard	1.1
			2 : Low	1.2
			3 : High	1.3
			4 : Super High	1.4
2	Group Control	2	0 : Set to Master	2.0
			1 : Set to Slave	2.1
			2 : Check Master/Slave	2.2
	Auxiliary heater	2	3 : Set to Auxiliary heater	2.3
			4 : Cancel Auxiliary heater	2.4
			5 : Check Auxiliary heater Installation	2.5

Mode Override

This Function is only for Non-Auto Changeover H/P model.

Ceiling Height Selection

Indoor unit connected to wired remote controller operate as wired remote controller setting.

Group Control

This function is only for group control. Please don't set this function in case of non-group control.

After setting Group Control of the product, turn off the power then turn it back on after 1 minute.

Auxiliary heater

This function is only applied to models with Auxiliary Heater function being activated.

Installer Setting - Setting Address of Central Control

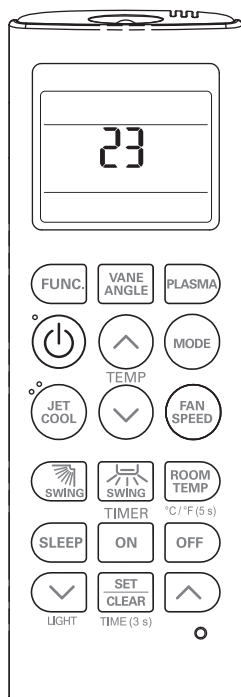

- 1 With the MODE button pressed, press the RESET button.
- 2 By using the temperature setting button, set the indoor unit address.
- Setting range : 00 ~ FF
- 3 After setting the address, press the ON/OFF button toward the indoor unit 1 time.
- 4 The indoor unit will display the set address to complete the address setting.
- The address display time and method can differ by the indoor unit type.
- 5 Reset the remote controller to use the general operation mode.

Installer Setting - Checking Address of Central Control

- 1 With the FUNC. button pressed, press the RESET button.
- 2 Press the ON/OFF button toward the indoor unit 1 time, and the indoor unit will display the set address in the display window.
- The address display time and method can differ by the indoor unit type.
- 3 Reset the remote controller to use the general operation mode.



US	Please call the installing contractor of your product, as warranty service will be provided by them.
CANADA	Service call Number # : (888) LG Canada, (888) 542-2623 Numéro pour les appels de service : LG Canada, 1-888-542-2623