

SERVICE MANUAL R410A

[Model Name]	[Service Ref.]
SUZ-KA24NAHZ	SUZ-KA24NAHZ
SUZ-KA30NAHZ	SUZ-KA30NAHZ
SUZ-KA36NAHZ	SUZ-KA36NAHZ

Revision:
 • Note has been added in "3. FEATURES" in REVISED EDITION-C.

OCH754B is void.

Note:
 • This manual describes service data of the outdoor units only.

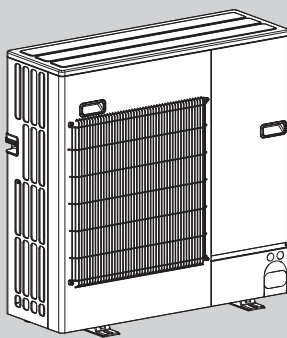

SUZ-KA24NAHZ

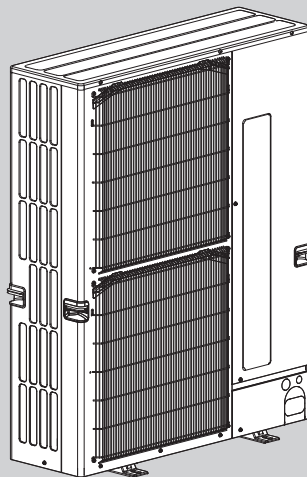

**SUZ-KA30NAHZ
SUZ-KA36NAHZ**

CONTENTS

1. REFERENCE MANUAL	2
2. SAFETY PRECAUTION	2
3. FEATURES	6
4. SPECIFICATIONS	7
5. DATA	9
6. OUTLINES AND DIMENSIONS	13
7. WIRING DIAGRAM	15
8. WIRING SPECIFICATIONS	17
9. REFRIGERANT SYSTEM DIAGRAM ..	20
10. TROUBLESHOOTING	23
11. EASY MAINTENANCE FUNCTION	74
12. FUNCTION SETTING	76
13. MONITORING THE OPERATION DATA BY THE REMOTE CONTROLLER	78
14. DISASSEMBLY PROCEDURE	87
15. REMOTE CONTROLLER	100

PARTS CATALOG (OCB754)

1

REFERENCE MANUAL

INDOOR UNIT SERVICE MANUAL

Model Name	Service Ref.	Service Manual No. Parts Catalog No.
PEAD-A24/30/36AA7	PEAD-A24/30/36AA7	HWE1608A BWE01629A
SVZ-KP24/30/36NA	SVZ-KP24/30/36NA	MD-1404-K019 MD-1404-K018

2

SAFETY PRECAUTION

2-1. ALWAYS OBSERVE FOR SAFETY

Before obtaining access to terminal, all supply circuits must be disconnected.

Preparation before the repair service.

- Prepare the proper tools.
- Prepare the proper protectors.
- Provide adequate ventilation.
- After stopping the operation of the air conditioner, turn off the power-supply breaker.
- Discharge the condenser before the work involving the electric parts.

Precautions during the repair service.

- Do not perform the work involving the electric parts with wet hands.
- Do not pour water into the electric parts.
- Do not touch the refrigerant.
- Do not touch the hot or cold areas in the refrigerating cycle.
- When the repair or the inspection of the circuit needs to be done without turning off the power, exercise great caution not to touch the live parts.
- When opening or closing the valve below freezing temperatures, refrigerant may spurt out from the gap between the valve stem and the valve body, resulting in injuries.

2-2. CAUTIONS RELATED TO NEW REFRIGERANT

Caution for units utilizing refrigerant R410A

Use new refrigerant pipes.

In the case of using the existing pipes for R22, be careful with the following:

- Be sure to clean the pipes and make sure that the insides of the pipes are clean.
- Change flare nut to the one provided with this product. Use a newly flared pipe.
- Avoid using thin pipes.

Make sure that the inside and outside of refrigerant piping is clean and it has no contaminants such as sulfur, oxides, dirt, shaving particles, etc, which are hazard to refrigerant cycle. In addition, use pipes with specified thickness.

Contamination inside refrigerant piping can cause deterioration of refrigerant oil, etc.

Store the piping indoors, and both ends of the piping sealed until just before brazing. (Leave elbow joints, etc. in their packaging.)

If dirt, dust or moisture enters into refrigerant cycle, that can cause deterioration of refrigerant oil or malfunction of compressor.

The refrigerant oil applied to flare and flange connections must be ester oil, ether oil or alkylbenzene oil in a small amount.

If large amount of mineral oil enters, that can cause deterioration of refrigerant oil, etc.

Charge refrigerant from liquid phase of gas cylinder.

If the refrigerant is charged from gas phase, composition change may occur in refrigerant and the efficiency will be lowered.

Do not use refrigerant other than R410A.

If other refrigerant (R22, etc.) is used, chlorine in refrigerant can cause deterioration of refrigerant oil, etc.

Use a vacuum pump with a reverse flow check valve.

Vacuum pump oil may flow back into refrigerant cycle and that can cause deterioration of refrigerant oil, etc.

Use the following tools specifically designed for use with R410A refrigerant.

The following tools are necessary to use R410A refrigerant.

Tools for R410A	
Gauge manifold	Flare tool
Charge hose	Size adjustment gauge
Gas leak detector	Vacuum pump adaptor
Torque wrench	Electronic refrigerant charging scale

Handle tools with care.

If dirt, dust or moisture enters into refrigerant cycle, that can cause deterioration of refrigerant oil or malfunction of compressor.

Do not use a charging cylinder.

If a charging cylinder is used, the composition of refrigerant will change and the efficiency will be lowered.

Use the specified refrigerant only.

Never use any refrigerant other than that specified. Doing so may cause a burst, an explosion, or fire when the unit is being used, serviced, or disposed of. Correct refrigerant is specified in the manuals and on the spec labels provided with our products. We will not be held responsible for mechanical failure, system malfunction, unit breakdown or accidents caused by failure to follow the instructions.

Ventilate the room if refrigerant leaks during operation. If refrigerant comes into contact with a flame, poisonous gases will be released.

[1] Cautions for service

- (1) Perform service after recovering the refrigerant left in unit completely.
- (2) Do not release refrigerant in the air.
- (3) After completing service, charge the cycle with specified amount of refrigerant.
- (4) When performing service, install a filter drier simultaneously.
Be sure to use a filter drier for new refrigerant.

[2] Additional refrigerant charge

When charging directly from cylinder

- Check that cylinder for R410A on the market is a syphon type.
- Charging should be performed with the cylinder of syphon stood vertically. (Refrigerant is charged from liquid phase.)

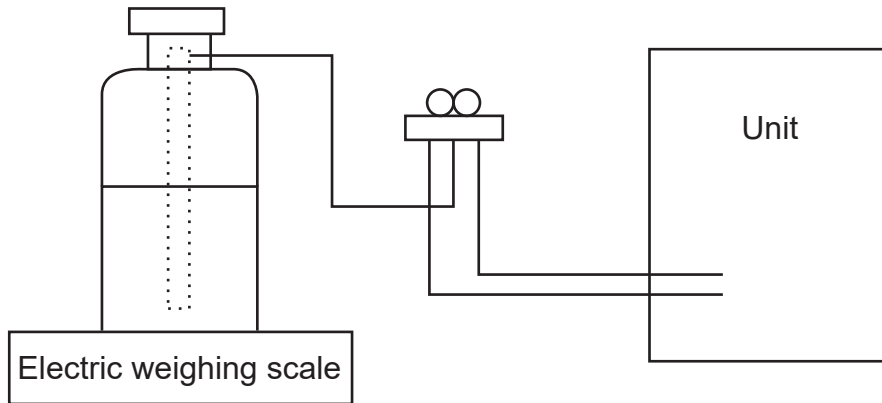

[3] Service tools

Use the below service tools as exclusive tools for R410A refrigerant.

No.	Tool name	Specifications
1	Gauge manifold	· Only for R410A · Use the existing fitting specifications. · Use high-tension side pressure of 5.3 MPa·G or over.
2	Charge hose	· Only for R410A · Use pressure performance of 5.09 MPa·G or over.
3	Electronic weighing scale	—
4	Gas leak detector	· Use the detector for R134a, R407C or R410A.
5	Adaptor for reverse flow check	· Attach on vacuum pump.
6	Refrigerant charge base	—
7	Refrigerant cylinder	· Only for R410A · Cylinder with syphon · Top of cylinder (Pink)
8	Refrigerant recovery equipment	—

2-3. CAUTIONS FOR REFRIGERANT PIPING WORK

New refrigerant R410A is adopted for replacement inverter series. Although the refrigerant piping work for R410A is same as for R22, exclusive tools are necessary so as not to mix with different kind of refrigerant. Furthermore as the working pressure of R410A is 1.6 time higher than that of R22, their sizes of flared sections and flare nuts are different.

① Thickness of pipes

Because the working pressure of R410A is higher compared to R22, be sure to use refrigerant piping with thickness shown below. (Never use pipes of 7/256 inch [0.7mm] or below.)

Nominal dimensions (in)	Outside diameter (mm)	Thickness: in (mm)	
		R410A	R22
1/4	6.35	1/32 (0.8)	1/32 (0.8)
3/8	9.52	1/32 (0.8)	1/32 (0.8)
1/2	12.70	1/32 (0.8)	1/32 (0.8)
5/8	15.88	5/128 (1.0)	5/128 (1.0)
3/4	19.05	—	5/128 (1.0)

② Dimensions of flare cutting and flare nut

The component molecules in HFC refrigerant are smaller compared to conventional refrigerants. In addition to that, R410A is a refrigerant, which has higher risk of leakage because its working pressure is higher than that of other refrigerants. Therefore, to enhance air tightness and intensity, flare cutting dimension of copper pipe for R410A has been specified separately from the dimensions for other refrigerants as shown below. The dimension B of flare nut for R410A also has partly been changed to increase strength as shown below. Set copper pipe correctly referring to copper pipe flaring dimensions for R410A below. For 1/2 and 5/8 inch pipes, the dimension B changes. Use torque wrench corresponding to each dimension.

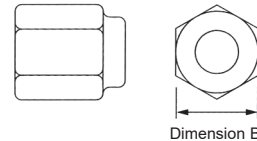
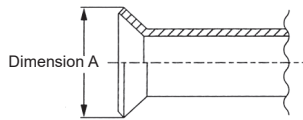

Diagram below: Piping diameter and thickness

Nominal dimensions (in)	Outside diameter (mm)	Thickness: in (mm)	
		R410A	R22
1/4	6.35	1/32 (0.8)	1/32 (0.8)
3/8	9.52	1/32 (0.8)	1/32 (0.8)
1/2	12.70	1/32 (0.8)	1/32 (0.8)
5/8	15.88	5/128 (1.0)	5/128 (1.0)
3/4	19.05	—	5/128 (1.0)

Flare nut dimensions

Nominal dimensions (in)	Outside diameter (mm)	Dimension B: in (mm)	
		R410A	R22
1/4	6.35	43/64 (17.0)	17.0
3/8	9.52	7/8 (22.0)	22.0
1/2	12.70	1-3/64 (26.0)	24.0
5/8	15.88	1-9/64 (29.0)	27.0
3/4	19.05	—	36.0

③ Tools for R410A (The following table shows whether conventional tools can be used or not.)

Tools and materials	Use	R410A tools	Can R22 tools be used?
Gauge manifold	Air purge, refrigerant charge and operation check	Tool exclusive for R410A	×
Charge hose		Tool exclusive for R410A	×
Gas leak detector	Gas leak check	Tool for HFC refrigerant	×
Refrigerant recovery equipment	Refrigerant recovery	Tool exclusive for R410A	×
Refrigerant cylinder	Refrigerant charge	Tool exclusive for R410A	×
Applied oil	Apply to flared section	Ester oil and alkylbenzene oil (minimum amount)	×
Safety charger	Prevent compressor malfunction when charging refrigerant by spraying liquid refrigerant	Tool exclusive for R410A	×
Charge valve	Prevent gas from blowing out when detaching charge hose	Tool exclusive for R410A	×
Vacuum pump	Vacuum drying and air purge	Tools for other refrigerants can be used if equipped with adopter for reverse flow check	△(Usable if equipped with adopter for reverse flow)
Flare tool	Flaring work of piping	Tools for other refrigerants can be used by adjusting flaring dimension	△(Usable by adjusting flaring dimension)
Bender	Bend the pipes	Tools for other refrigerants can be used	○
Pipe cutter	Cut the pipes	Tools for other refrigerants can be used	○
Welder and nitrogen gas cylinder	Weld the pipes	Tools for other refrigerants can be used	○
Refrigerant charging scale	Recover refrigerant	Tools for other refrigerants can be used	○
Vacuum gauge or thermistor vacuum gauge and vacuum valve	Check the degree of vacuum. (Vacuum valve prevents back flow of oil and refrigerant to thermistor vacuum gauge)	Tools can be used for other refrigerants.	○
Charging cylinder	Recover refrigerant	Tool exclusive for R410A	×

× : Prepare a new tool. (Use the new tool as the tool exclusive for R410A.)

△ : Tools for other refrigerants can be used under certain conditions.

○ : Tools for other refrigerants can be used.

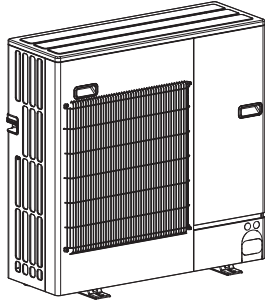

SUZ-KA24NAHZ

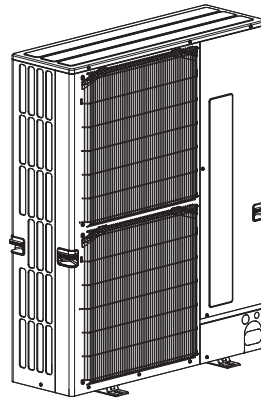
SUZ-KA30NAHZ
SUZ-KA36NAHZ

CHARGELESS SYSTEM

PRE-CHARGED REFRIGERANT IS SUPPLIED FOR PIPING LENGTH AT SHIPMENT.

Maximum 100 ft, 30 m (KA30/36), 70ft, 21m (KA24).

The refrigerant circuit with LEV(Linear Expansion Valve) and power receiver always control the optimal refrigerant level regardless of the length (maximum: 100 ft [30 m] (KA30/36), 70ft [21m] (KA24) and minimum: 16 ft [5 m]) of piping. The additional refrigerant charging work during installation often causes problems. It is completely eliminated by chargeless system. This unique system improves the quality and reliability of the work done. It also helps to speed up the installation time.

Note:

Please carefully consider the indoor unit location when piping lengths are less than 16 ft. (5 m) as there could be intermittent noises during normal operation that would be noticeable in very quiet environments.

4

SPECIFICATIONS

Service Ref.		SUZ-KA24NAHZ	SUZ-KA30NAHZ	
Power supply	Phase	Single		
	Cycle	60 Hz		
	Voltage	208/230 V		
MCA	A	17	24	
MOCP	A	27	40	
Breaker size	A	25	35	
External finish	Munsell 3Y 7.8/1.1			
Heat exchanger	Plate fin coil			
Defrost method	Reverse cycle			
Crankcase heater	kW	—		
Compressor	Hermetic			
	Model	DNB28FBAMT	ANB33FJMMT	
	Motor output	2.2	2.5	
	R.L.A.	9.0	18.0	
	L.R.A.	18.0	27.5	
	Starter type	Inverter		
Fan	Fan(drive) × No.	Propeller fan x 1	Propeller fan x 2	
	Fan motor output	0.074	0.074 + 0.074	
	Fan motor	F.L.A.	0.33	0.33 + 0.33
	Airflow	m3/min	58	115
		CFM	2050	4060
Sound pressure level (SPL)	Cooling	52	52	
	Heating	53	53	
Protection devices	HP switch			
	Comp. Surface thermistor			
Dimensions	W	in	37-13/32	41-11/32
	D	in	12-63/64+63/64	
	H	in	37-1/8	52-43/64
	W	mm	950	1050
	D	mm	330 + 25	
	H	mm	943	1338
Weight		lb	190	261
		kg	86	118
Refrigerant	R410A			
Charged		lb	7.72	11.46
		kg	3.5	5.2
Control	Linear expansion valve			
Oil Charged	Model	FVC68D	FV50S	
		oz	34	47
		L	1.0	1.4
Refrigerant piping	Pipe size O.D. Liquid	in	3/8	
		mm	9.52	
	Pipe size O.D. Gas	in	5/8	
		mm	15.88	
	Connection method Indoor	Flared		
	Connection method Outdoor	Flared		
	Height difference IU-OU	ft	Maximum 100	
		m	Maximum 30	
	Piping length	ft	Maximum 100	
		m	Maximum 30	

Service Ref.		SUZ-KA36NAHZ	
Power supply	Phase		Single
	Cycle		60Hz
	Voltage		208/230 V
MCA	A	26	
MOCP	A	42	
Breaker size	A	35	
External finish		Munsell 3Y 7.8/1.1	
Heat exchanger		Plate fin coil	
Defrost method		Reverse cycle	
Crankcase heater	kW	—	
Compressor		Hermetic	
	Model	ANB33FJMMT	
	Motor output	kW	2.5
	R.L.A.	18.0	
	L.R.A.	27.5	
	Starter type	Inverter	
Fan	Fan(drive) × No.		Propeller fan x 2
	Fan motor output	kW	0.074 + 0.074
	Fan motor	F.L.A.	0.33 + 0.33
	Airflow	m3/min	115
		CFM	4060
Sound pressure level (SPL)	Cooling	dB	52
	Heating	dB	53
Protection devices		HP switch Comp. Surface thermistor	
Dimensions	W	in	41-11/32
	D	in	12-63/64+63/64
	H	in	52-43/64
	W	mm	1050
	D	mm	330 + 25
	H	mm	1338
Weight		lb	261
		kg	118
Refrigerant		R410A	
	Charged	lb	11.46
		kg	5.2
	Control		Linear expansion valve
	Oil Charged	Model	FV50S
		oz	47
		L	1.4
Refrigerant piping	Pipe size O.D. Liquid	in	3/8
		mm	9.52
	Pipe size O.D. Gas	in	5/8
		mm	15.88
	Connection method Indoor		Flared
	Connection method Outdoor		Flared
	Height difference IU-OU	ft	Maximum 100
		m	Maximum 30
	Piping length	ft	Maximum 100
m		Maximum 30	

5

DATA

5-1. REFILLING REFRIGERANT CHARGE (R410A: oz, kg)

Service Ref.	Piping Length (one way)				Factory Charged
	70 ft	80 ft	90 ft	100 ft	
	21 m	24 m	27 m	30 m	
SUZ-KA24NAHZ	-	7 oz	14 oz	21 oz	123 oz
	-	0.2 kg	0.4 kg	0.6 kg	3.5 kg
SUZ-KA30NAHZ SUZ-KA36NAHZ	-	-	-	-	183 oz 5.2 kg

For pipes longer than 70 ft, additional charge is required.

5-2. COMPRESSOR TECHNICAL DATA

Winding temperature at 68°F [20°C]

Service Ref.		SUZ-KA24NAHZ	SUZ-KA30NAHZ	SUZ-KA36NAHZ
Compressor model		DNB28FBAMT	ANB33FJMMT	
Winding Resistance (Ω)	U - V	0.74	0.188	
	U - W	0.74	0.188	
	W - V	0.74	0.188	

5-3. NOISE CRITERION CURVES

SUZ-KA24NAHZ

MODE	SPL(dB)	LINE
COOLING	52	○—○
HEATING	53	●—●

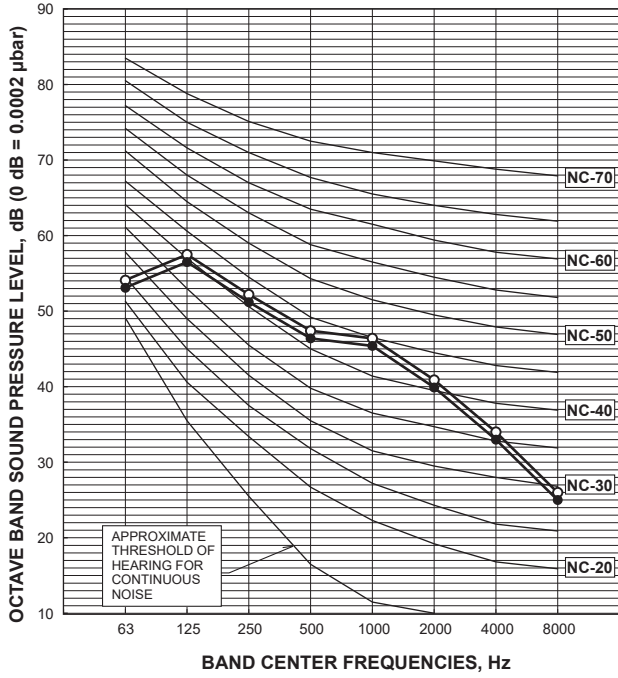

SUZ-KA30NAHZ
SUZ-KA36NAHZ

MODE	SPL(dB)	LINE
COOLING	52	○—○
HEATING	53	●—●

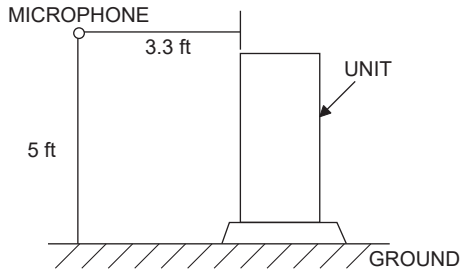
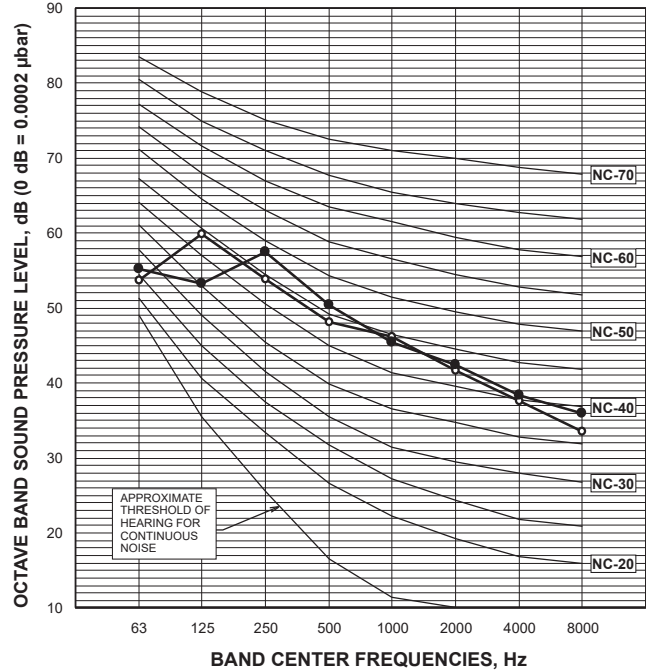

5-4. STANDARD OPERATION DATA

Representative matching			SVZ-KP24NA		SVZ-KP30NA	
Mode			COOLING	HEATING	COOLING	HEATING
Total	Capacity	Btu/h	24,000	23,000	27,000	32,000
	Input	W	2,420	2,410	2,160	2,400
Electrical circuit	Indoor unit model		SVZ-KP24NA		SVZ-KP30NA	
	Phase		Single			
	Cycle		60 Hz			
	Voltage		208/230 V			
	Current		1.40 A		1.70 A	
	Outdoor unit model		SUZ-KA24NAHZ		SUZ-KA30NAHZ	
	Phase		Single		Single	
	Cycle		60 Hz		60 Hz	
	Voltage		208/230 V		208/230 V	
	Current		9.12 A	9.08 A	7.69 A	8.73 A
Refrigerant circuit	Discharge pressure	PSIG	412	368	368	339
	Suction pressure	PSIG	131	106	146	111
	Discharge temperature	°F	159	152	146	149
	Condensing temperature	°F	118	109	110	104
	Suction temperature	°F	51	39	57	45
	Ref. Pipe length	ft	25	25	25	25
	Discharge pressure	Mpa	2.84	2.54	2.54	2.33
	Suction pressure	Mpa	0.90	0.73	1.01	0.77
	Discharge temperature	°C	70.6	66.9	63.4	64.8
	Condensing temperature	°C	47.9	42.5	43.6	39.8
	Suction temperature	°C	10.8	4.2	14.1	7.2
	Ref. Pipe length	m	7.6	7.6	7.6	7.6
Indoor side	Intake air temperature D.B.	°F	80	70	80	70
	Intake air temperature W.B.	°F	67	60	67	60
	Discharge air temperature D.B.	°F	59	101	59	101
Outdoor side	Intake air temperature D.B.	°F	95	47	95	47
	Intake air temperature W.B.	°F	75	44	75	43
Indoor side	Intake air temperature D.B.	°C	26.6	21.4	26.7	21.1
	Intake air temperature W.B.	°C	19.5	15.6	19.5	15.6
	Discharge air temperature D.B.	°C	14.9	38.2	14.8	38.2
Outdoor side	Intake air temperature D.B.	°C	35.1	8.5	35.0	8.3
	Intake air temperature W.B.	°C	23.9	6.6	23.9	6.1
SHF			0.78	-	0.83	-
BF			0.15	-	0.08	-

Representative matching			SVZ-KP36NA	
Mode			COOLING	HEATING
Total	Capacity	Btu/h	36,000	37,000
	Input	W	3,790	3,280
Electrical circuit	Indoor unit model		SVZ-KP36NA	
	Phase		Single	
	Cycle		60 Hz	
	Voltage		208/230 V	
	Current		2.70 A	
	Outdoor unit model		SUZ-KA36NAHZ	
	Phase		Single	
	Cycle		60 Hz	
	Voltage		208/230 V	
	Current		13.78 A	11.56 A
Refrigerant circuit	Discharge pressure	PSIG	403	376
	Suction pressure	PSIG	125	103
	Discharge temperature	°F	165	168
	Condensing temperature	°F	117	110
	Suction temperature	°F	50	45
	Ref. Pipe length	ft	25	25
	Discharge pressure	Mpa	2.78	2.59
	Suction pressure	Mpa	0.86	0.71
	Discharge temperature	°C	73.7	75.6
	Condensing temperature	°C	47.3	43.4
	Suction temperature	°C	9.9	7.4
	Ref. Pipe length	m	7.6	7.6
Indoor side	Intake air temperature D.B.	°F	80	70
	Intake air temperature W.B.	°F	67	60
	Discharge air temperature D.B.	°F	55	107
Outdoor side	Intake air temperature D.B.	°F	95	47
	Intake air temperature W.B.	°F	75	43
Indoor side	Intake air temperature D.B.	°C	26.7	21.1
	Intake air temperature W.B.	°C	19.5	15.7
	Discharge air temperature D.B.	°C	12.9	41.7
Outdoor side	Intake air temperature D.B.	°C	35.0	8.3
	Intake air temperature W.B.	°C	23.9	6.1
SHF			0.74	-
BF			0.2	-

SUZ-KA24NAHZ

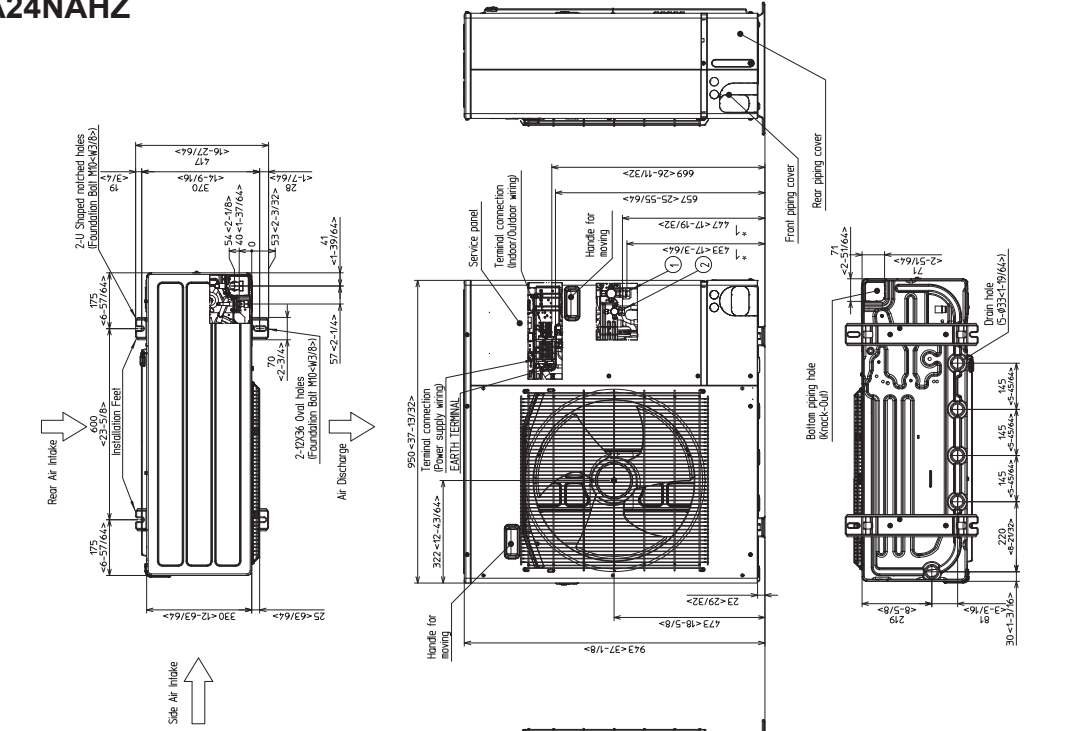

4. PIPING-WIRING DIRECTIONS
Piping and wiring connections can be made from 4 directions: FRONT, Right, Rear and Below.

3 FOUNDATION BOLTS
Please secure the unit firmly with 4 foundation (M10×M3/8) bolts. (Bolts and washers must be purchased locally.)

2 SERVICE SPACE
Dimensions of space needed for service access are shown in the below diagram.

1 FREE SPACE (Around the unit)
The diagram below shows a basic example. Explanation of particular details are given in the installation manuals etc.

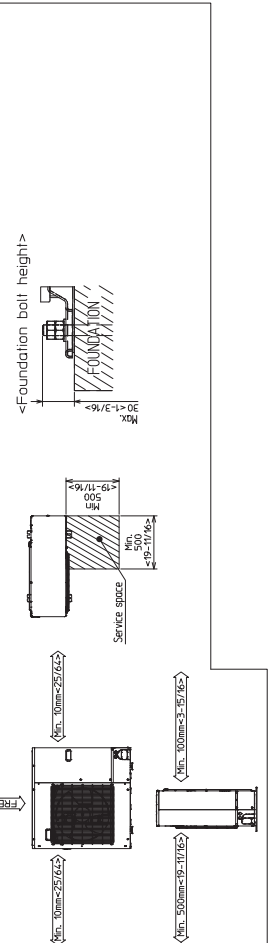

Example of Notes

- ① ...Refrigerant GAS pipe connection (FLARE)φ15.88(5/8)F.
 - ② ...Refrigerant LIQUID pipe connection (FLARE)φ9.52(3/8)F.
- *1...Indication of VALVE connection location.

Piping Knock-Out Hole Details

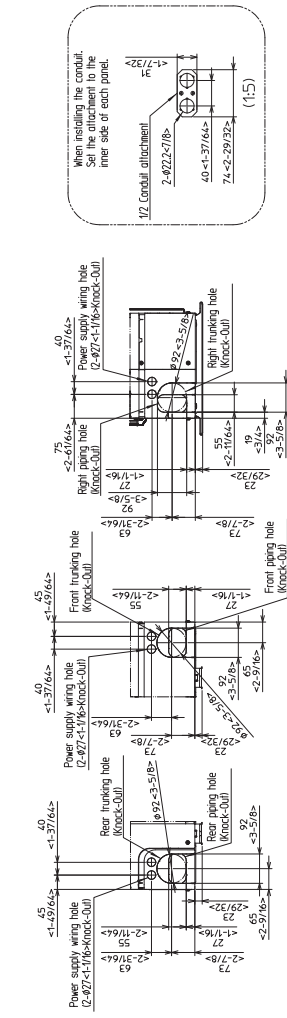

SUZ-KA30NAHZ SUZ-KA36NAHZ

Unit: mm<in>

1 FREE SPACE (Around the unit)

The diagram below shows a basic example. Explanation of particular details are given in the installation manuals etc.

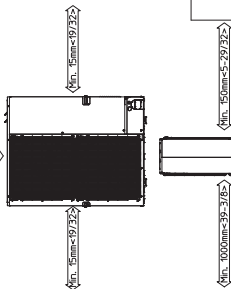

2 SERVICE SPACE

Dimensions of space needed for service access are shown in the below diagram.

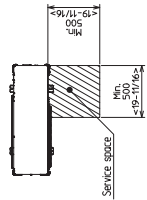

3 FOUNDATION BOLTS

Please secure the unit firmly with 4 foundation bolts (M10x150) bolts. Bolts and washers must be purchased locally.

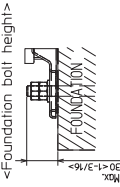

4 PIPING-WIRING DIRECTIONS

Piping and wiring connections can be made from 4 directions: FRONT, Right, Rear and Below.

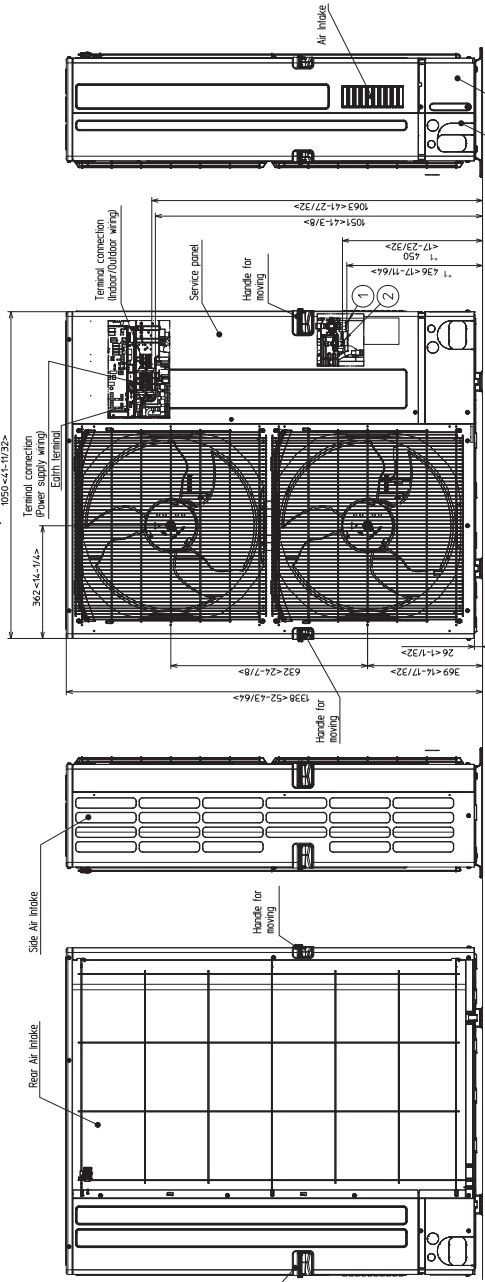
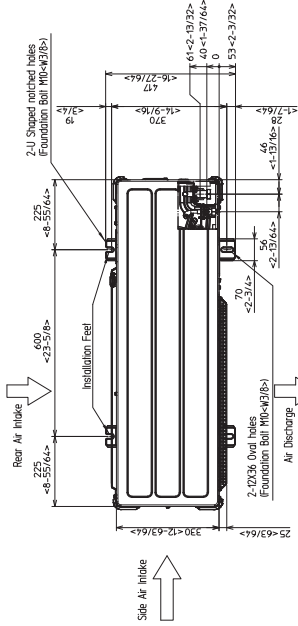

Example of Notes

- ① ...Refrigerant GAS pipe connection (FLARE)φ15.88(5/8F).
 - ② ...Refrigerant LIQUID pipe connection (FLARE)φ9.52(3/8F).
- *1 ...Indication of VALVE connection location.

Piping Knock-Out Hole Details

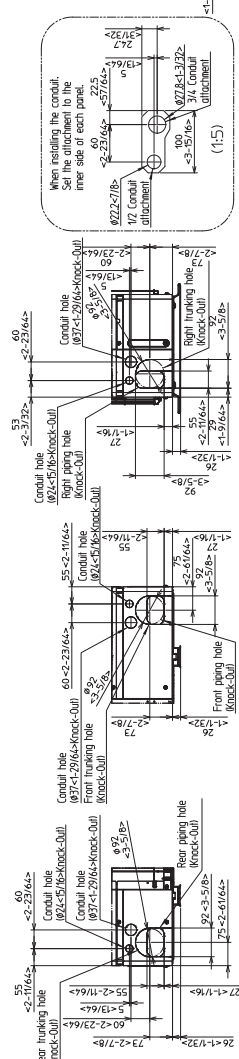

SUZ-KA24NAHZ

SYMBOL	NAME	SYMBOL	NAME	SYMBOL	NAME
TB1	Terminal Block (Power Supply)	TH8	Thermistor (Heat Sink)	SW5	Switch (Function Switch, Model Select)
TB2	Terminal Block (Indoor/Outdoor)	TH33	Thermistor (Comp. Surface)	SW6	Switch (Model Select)
MC	Motor for Compressor	LEV-A, LEV-B	Linear Expansion Valve	SW7	Switch (Function Switch)
MF1	Fan Motor	DCL	Reactor	SW8	Switch (Function Switch)
21S4	Solenoid Valve (4-Way Valve)	CY1, CY2	Capacitor	SW9	Switch (Function Switch)
63H	High Pressure Switch	P. B.	Power Circuit Board	SWP	Switch (Pump Down)
BH	Base Heater	C. B.	Controller Circuit Board	CNM	Connector (Connection for Option)
THP	Thermal Protector	F1, F2	Fuse (T10AL250V)	CN31	Connector (Emergency Operation)
TH3	Thermistor (Liquid)	F3, F4	Fuse (T6.3AL250V)	CNDM	Connector (Connection for Option)
TH4	Thermistor (Discharge)	SW1	Switch (Manual Defrost, Defect History Record Reset, Refrigerant Address)	SV2	Connector
TH6	Thermistor (2-Phase Pipe)	SW4	Switch (Function Switch)	X52, X55	Relay
TH7	Thermistor (Ambient)				

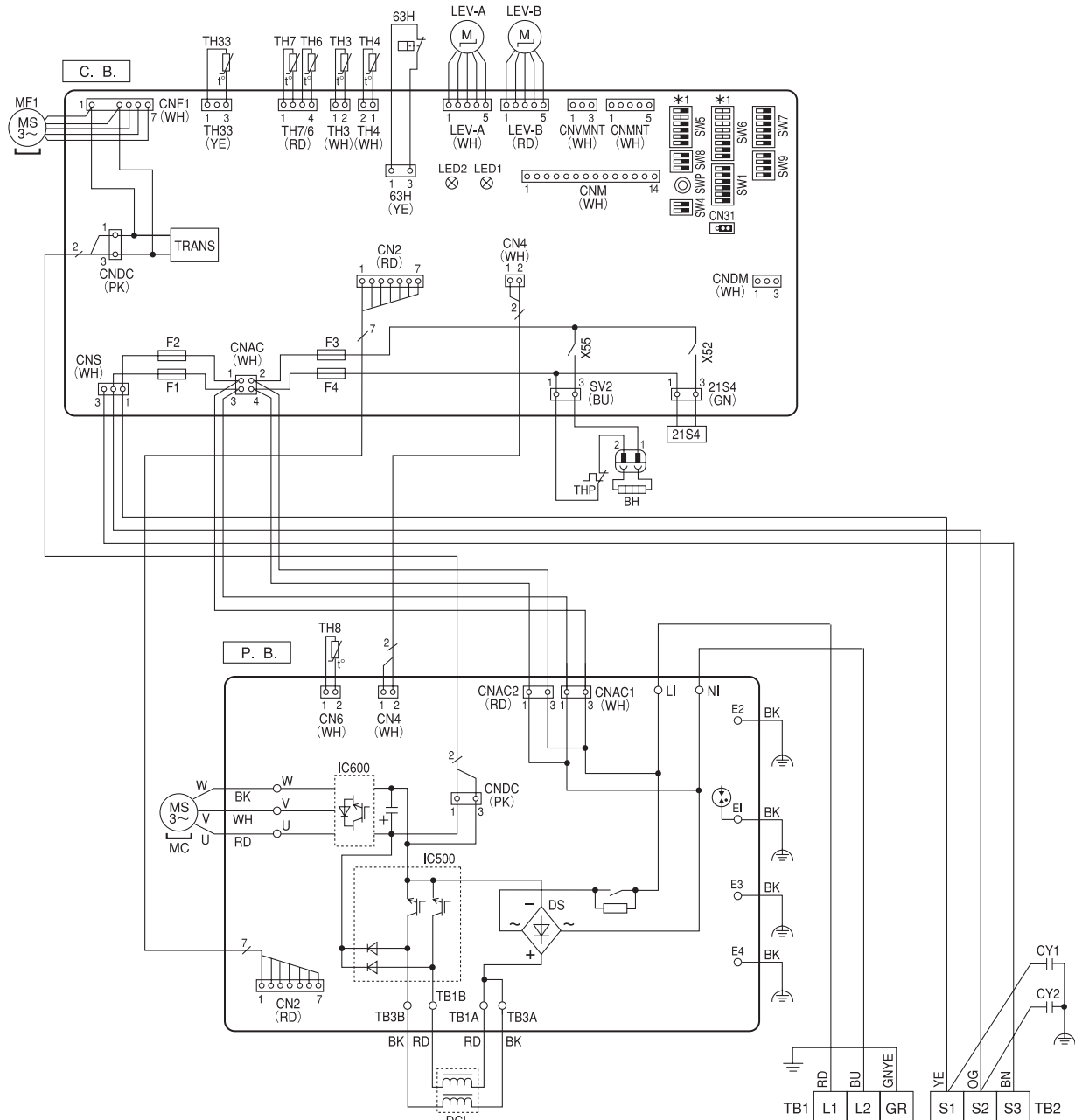

*1. MODEL SELECT
The black square (■) indicates a switch position.

MODEL	SW6-4, 5, 6, 7, 8 *2	SW5-5 *2
SUZ-KA24NAHZ	ON OFF ■ ■ ■ ■ ■ ■ ■ ■ 1 2 3 4 5 6 7 8	ON OFF ■ ■ ■ ■ ■ ■ ■ ■ 1 2 3 4 5 6

*2. SW6-1 to 3, SW5-1 to 4, 6 : Function Switch

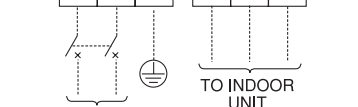

POWER SUPPLY
208/230 V AC 60 Hz

*Use copper supply wires.
*Utiliser des fils d'alimentation en cuivre.

SUZ-KA30NAHZ

SUZ-KA36NAHZ

SYMBOL	NAME	SYMBOL	NAME	SYMBOL	NAME
TB1	Terminal Block (Power Supply)	TH8	Thermistor (Heat Sink)	SW4	Switch (Function Switch)
TB2	Terminal Block (Indoor/Outdoor)	TH32	Thermistor (Suction)	SW5	Switch (Function Switch, Model Select)
MC	Motor for Compressor	TH33	Thermistor (Comp. Surface)	SW6	Switch (Model Select)
MF1, MF2	Fan Motor	LEV-A, LEV-B, LEV-C	Linear Expansion Valve	SW7	Switch (Function Switch)
21S4	Solenoid Valve (4-Way Valve)	DCL1, DCL2, DCL3	Reactor	SW8	Switch (Function Switch)
63H	High Pressure Switch	CY1, CY2	Capacitor	SW9	Switch (Function Switch)
BH	Base Heater	P. B.	Power Circuit Board	SWP	Switch (Pump Down)
THP	Thermal Protector	C. B.	Controller Circuit Board	CNM	Connector (Connection for Option)
TH3	Thermistor (Liquid)	F1, F2	Fuse (T10AL250V)	CN31	Connector (Emergency Operation)
TH4	Thermistor (Discharge)	F3, F4	Fuse (T6.3AL250V)	CNDM	Connector (Connection for Option)
TH6	Thermistor (2-Phase Pipe)	SW1	Switch (Manual Defrost, Defect History Record Reset, Refrigerant Address)	SV2	Connector
TH7	Thermistor (Ambient)			X52, X55	Relay

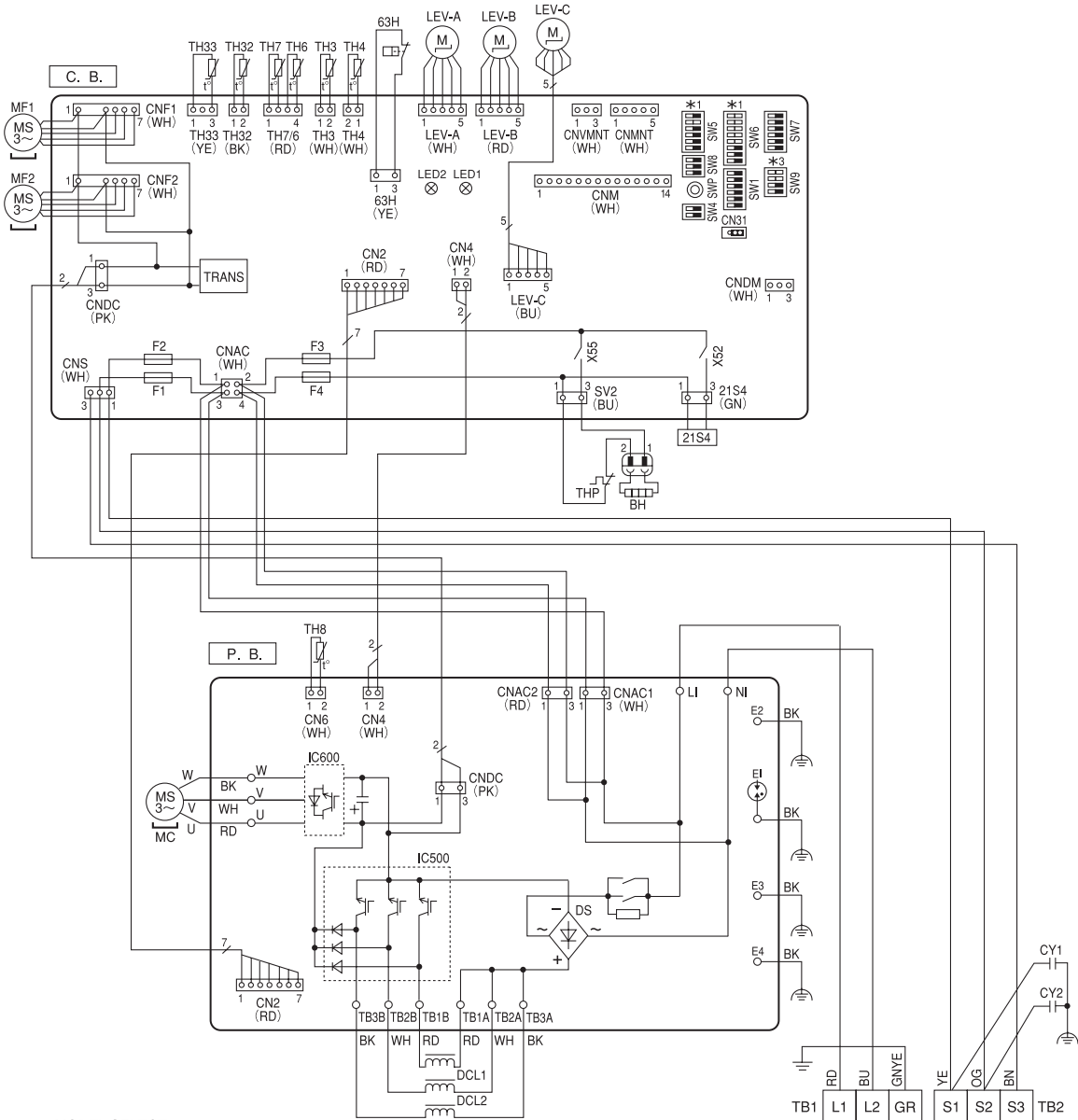

*1. MODEL SELECT

The black square (■) indicates a switch position.

MODEL	SW6-4, 5, 6, 7, 8 *2	SW5-5 *2	MODEL	SW6-4, 5, 6, 7, 8 *2	SW5-5 *2
SUZ-KA30NAHZ	ON OFF ■ ■ ■ ■ ■ ■ ■ ■ 1 2 3 4 5 6 7 8	ON OFF ■ ■ ■ ■ ■ ■ ■ ■ 1 2 3 4 5 6	SUZ-KA36NAHZ	ON OFF ■ ■ ■ ■ ■ ■ ■ ■ 1 2 3 4 5 6 7 8	ON OFF ■ ■ ■ ■ ■ ■ ■ ■ 1 2 3 4 5 6

*2. SW6-1 to 3, SW5-1 to 4, 6 : Function Switch

*3 Ambient temp. of ZUBADAN Flash Injection becomes effective.

The black square (■) indicates a switch position.

Ambient temp.	SW9-3,4 *4	Ambient temp.	SW9-3,4 *4	Ambient temp.	SW9-3,4 *4	Ambient temp.	SW9-3,4 *4
37°F or less (Initial setting)	ON OFF ■ ■ ■ ■ ■ ■ ■ ■ 1 2 3 4	32°F or less	ON OFF ■ ■ ■ ■ ■ ■ ■ ■ 1 2 3 4	27°F or less	ON OFF ■ ■ ■ ■ ■ ■ ■ ■ 1 2 3 4	21°F or less	ON OFF ■ ■ ■ ■ ■ ■ ■ ■ 1 2 3 4

*4 SW9-1 to 2 : Function Switch

POWER SUPPLY
208/230 V AC 60 Hz

*Use copper supply wires.

*Utiliser des fils d'alimentation en cuivre.

8-1. INDOOR UNIT POWER SUPPLIED FROM OUTDOOR UNIT

The following illustrations show available connection patterns.
The outdoor unit power supply patterns vary on each model.

1:1 System

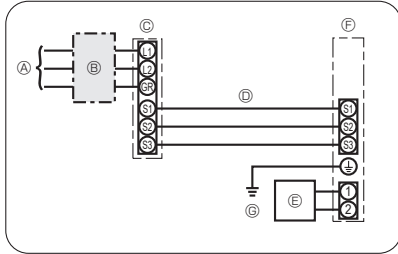

Simultaneous twin system

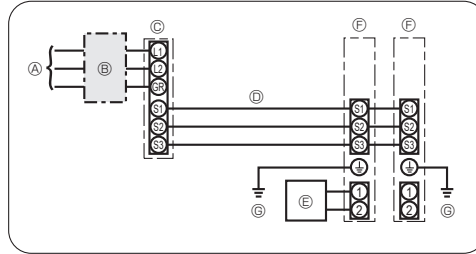

- Ⓐ Outdoor unit power supply
- Ⓑ Wiring circuit breaker or isolating switch
- Ⓒ Outdoor unit
- Ⓓ Indoor unit/outdoor unit connecting cords
- Ⓔ Remote controller
- Ⓕ Indoor unit
- Ⓖ Indoor unit earth

Affix a label A that is included with the manuals near each wiring diagram for the indoor and outdoor units.

Outdoor model name		KA24	KA30	KA36
Outdoor unit power supply		Single, 208/230 V, 60 Hz		
Breaker size		25 A	35 A	
Minimum circuit ampacity		17 A	24 A	26 A
Maximum rating of overcurrent protective device		27 A	40 A	42 A
Wiring	Outdoor unit power supply	2 × Min AWG 12		2 × Min AWG 10
Wire No. x size	Outdoor unit power supply earth	1 × Min AWG 12		1 × Min AWG 10
	Indoor unit-Outdoor unit *1	3 × AWG 14 (polar)		3 × AWG 14 (polar)
	Indoor unit earth	1 × Min AWG 14		1 × Min AWG 14
	Remote controller-Indoor unit *2	2 × AWG 22 (Non-polar)		2 × AWG 22 (Non-polar)
Circuit rating	Outdoor unit L1-L2 *3	208/230 VAC		208/230 VAC
	Indoor unit-Outdoor unit S1-S2 *3	208/230 VAC		208/230 VAC
	Indoor unit-Outdoor unit S2-S3 *3	24 VDC		24 VDC
	Remote controller-Indoor unit *3	12 VDC		12 VDC

Please follow applicable federal, state, or local codes to prevent potential leakage/electric shock. Or install a ground fault interrupt for the prevention of leakage and electric shock.

*1. Maximum 147 ft [45 m].

If AWG13 used, maximum 164 ft [50 m].

If AWG13 used and S3 separated, maximum 262 ft [80 m].

*2. The 30 ft [10 m] wire is attached in the remote controller accessory. Maximum 1500 ft [500 m].

*3. The figures are NOT always against the ground.

S3 terminal has 24 VDC against S2 terminal. However between S3 and S1, these terminals are NOT electrically insulated by the transformer or other device.

Notes: 1. Wiring size must comply with the applicable local and national code.

2. Use copper supply wires.

3. Use wires rated 600 V or more for the power supply cables and the indoor/outdoor unit connecting cables.

4. Install an earth line longer than power cables.

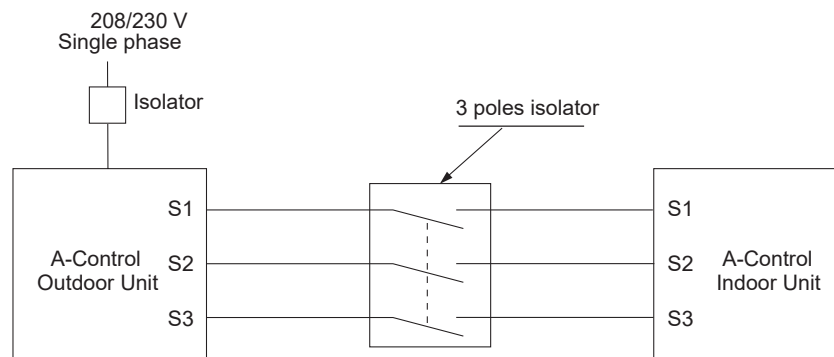

Warning:

In the case of A-control wiring, there is high voltage potential on the S3 terminal caused by electrical circuit design that has no electrical insulation between power line and communication signal line. Therefore, please turn off the main power supply when servicing. And do not touch the S1, S2, S3 terminals when the power is energized. If isolator should be used between indoor unit and outdoor unit, please use 3-pole type.

• Turn on the main power when the ambient temperature is, -4°F [-20°C] or higher.

• In below, -4°F [-20°C] condition, it needs at least 4 h standby to operate in order to warm the electrical parts.

8-2. SEPARATE INDOOR UNIT/OUTDOOR UNIT POWER SUPPLIES

The following illustrations show available connection patterns.
The outdoor unit power supply patterns vary on models.

1:1 System

The optional indoor power supply terminal kit is required.

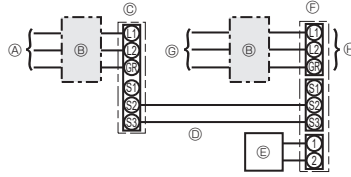

- Ⓐ Outdoor unit power supply
- Ⓑ Wiring circuit breaker or isolating switch
- Ⓒ Outdoor unit
- Ⓓ Indoor unit/outdoor unit connecting cords
- Ⓔ Remote controller
- Ⓕ Indoor unit
- Ⓖ Indoor unit power supply
- Ⓗ Option

Affix a label B that is included with the manuals near each wiring diagram for the indoor and outdoor units.

Simultaneous twin system

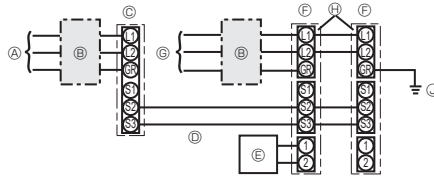

- Ⓐ Outdoor unit power supply
- Ⓑ Wiring circuit breaker or isolating switch
- Ⓒ Outdoor unit
- Ⓓ Indoor unit/outdoor unit connecting cords
- Ⓔ Remote controller
- Ⓕ Indoor unit
- Ⓖ Indoor unit power supply
- Ⓗ Option
- Ⓙ Indoor unit earth

Affix a label B that is included with the manuals near each wiring diagram for the indoor and outdoor units.

If the indoor and outdoor units have separate power supplies, refer to the table below.
Change the indoor unit electrical box wiring referring to the figure in the right and the DIP switch settings of the outdoor unit control board.

	Indoor unit specifications												
Indoor unit electrical box connector connection change	Required												
Label affixed near each wiring diagram for the indoor and outdoor units	Required												
Outdoor unit DIP switch settings (when using separate indoor unit/outdoor unit power supplies only)	ON <table border="1" style="display: inline-table; vertical-align: middle;"> <tr><td></td><td></td><td>3</td></tr> <tr><td>1</td><td>2</td><td></td></tr> </table> (SW8) OFF <table border="1" style="display: inline-table; vertical-align: middle;"> <tr><td></td><td></td><td></td></tr> <tr><td>1</td><td>2</td><td></td></tr> </table>			3	1	2					1	2	
		3											
1	2												
1	2												

Note:
There are 3 types of label; A, B and C.
Affix the appropriate label(s) to the units according to the wiring method.

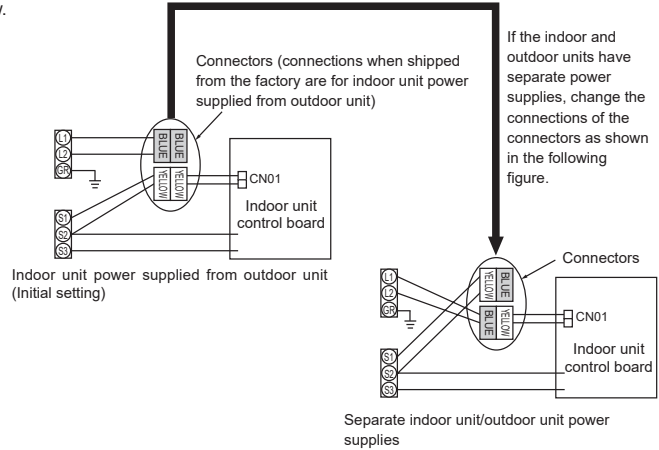

Indoor model name		A24	A30	A36
Indoor unit power supply		Single, 208/230 V, 60 Hz		
Minimum circuit ampacity	SVZ	3.00 A	4.13 A	4.13 A
	PEAD	2.63 A	2.73 A	3.3 A
Maximum rating of overcurrent protective device		15 A		
Wiring Wire No. x size	Indoor unit power supply	2 × Min AWG 16		
	Indoor unit power supply earth	1 × Min AWG 16		
	Indoor unit-Outdoor unit	*1	2 × AWG 22 (polar)	
	Indoor unit earth		-	
Circuit rating	Remote controller-Indoor unit	*2	2 × AWG 22 (Non-polar)	
	Outdoor unit L1-L2	*3	208/230 VAC	
	Indoor unit-Outdoor unit S1-S2	*3	-	
	Indoor unit-Outdoor unit S2-S3	*3	24 VDC	
	Remote controller-Indoor unit	*3	12 VDC	

*1. Maximum 165 ft [50 m]

*2. The 30 ft [10 m] wire is attached in the remote controller accessory. Maximum 1500 ft [500 m].

*3. The figures are NOT always against the ground.

- Notes:**
1. Wiring size must comply with the applicable local and national code.
 2. Use copper supply wires.
 3. Use wires rated 300 V or more for the power supply cables.
 4. Install an earth line longer than power cables

8-3. INDOOR – OUTDOOR CONNECTING CABLE

Outdoor power supply	Wire No. × Size		
	Max. 147 ft [45 m]	Max. 164 ft [50 m]	Max. 262 ft [80 m]
Indoor unit-Outdoor unit	3 × AWG15 (polar)	3 × AWG13 (polar)	3 × AWG13 (polar) and S3 separated

Note: The maximum cable length may vary depending on the condition of installation, humidity or materials, etc.

Indoor/Outdoor separate power supply	Wire No. × Size	
	Max. 393 ft [120 m]	
Indoor unit-Outdoor unit	2 × Min AWG22	

Note: The optional indoor power supply terminal kit is necessary.

Be sure to connect the indoor-outdoor connecting cables directly to the units (no intermediate connections). Intermediate connections can lead to communication errors if water enters the cables and causes insufficient insulation to ground or a poor electrical contact at the intermediate connection point.

SUZ-KA24NAHZ

Unit: in (mm)

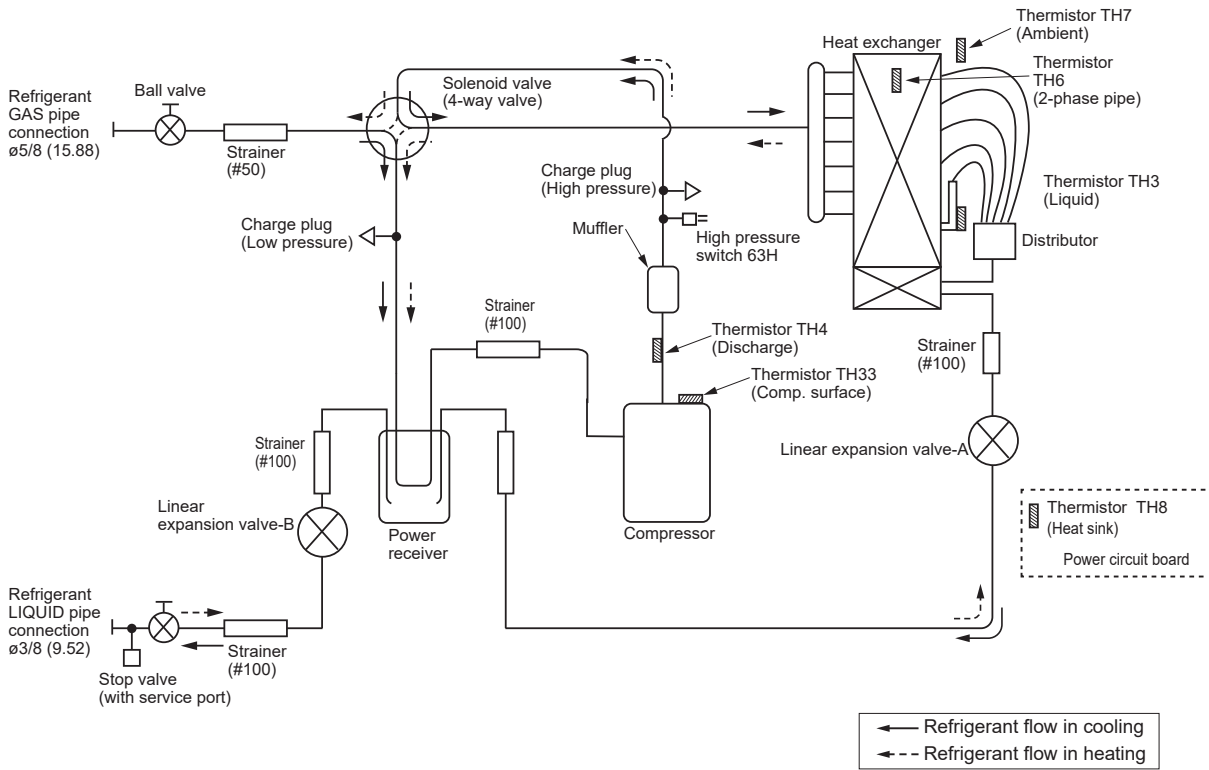

SUZ-KA30NAHZ SUZ-KA36NAHZ

Unit: in (mm)

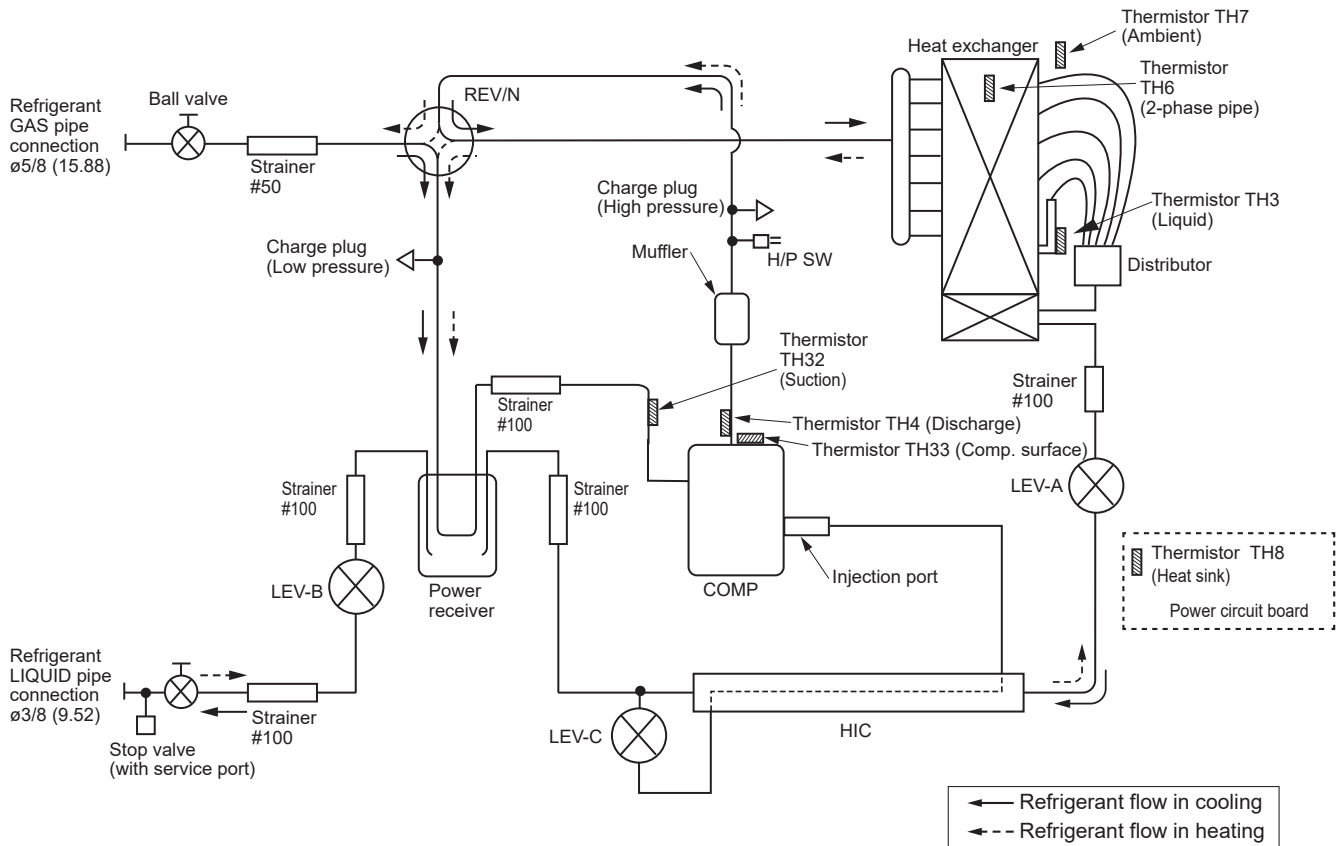

Symbol	Parts name	Detail
COMP	Compressor	DC inverter scroll compressor (Mitsubishi Electric Corporation)
H/P SW	High pressure switch (63H)	For protection (OFF: 4.15MPa)
REV/V	Reversing (4-way) valve (21S4)	Change the refrigerant circuit (Heating / Cooling) and for Defrosting
Charge plug	Charge plug	High pressure / Low pressure / For production test use
LEV-A	Linear expansion valve -A	Heating: Secondary LEV Cooling: Primary LEV
LEV-B	Linear expansion valve -B	Heating: Primary LEV Cooling: Secondary LEV
LEV-C	Linear expansion valve -C	For HIC (heating only)
TH32	Suction temperature thermistor	For LEV control
TH3	Liquid temperature thermistor	Heating: Evaporating temperature Cooling: Sub cool liquid temperature
TH4	Discharge temperature thermistor	For LEV control and for compressor protection
TH6	2-phase pipe temperature thermistor	Outdoor 2-phase pipe temperature
TH7	Ambient temperature thermistor	For fan control and for compressor frequency control
TH33	Comp. surface temperature thermistor	For protection
Power Receiver	Power Receiver	For accumulation of refrigerant
HIC	Heat interchange circuit	For high heating capacity

9-1. REFRIGERANT COLLECTING (PUMP DOWN)

When relocating or disposing of the indoor/outdoor unit, pump down the system following the procedures below so that no refrigerant is released into the atmosphere.

- ① Turn off the power supply (circuit breaker).
- ② Connect the low pressure valve on the gauge manifold to the charge plug (low pressure side) on the outdoor unit.
- ③ Close the liquid stop valve completely.
- ④ Supply power (circuit breaker).
 - When power is supplied, make sure that “Centrally controlled” is not displayed on the remote controller. If “Centrally controlled” is displayed, the refrigerant collecting (pump down) cannot be completed normally.
 - Startup of the indoor-outdoor communication takes about 3 minutes after the power (circuit breaker) is turned on. Start the pump-down operation 3 to 4 minutes after the power (circuit breaker) is turned on.
- ⑤ Perform the refrigerant collecting operation (cooling test run).
 - Push the pump-down SWP switch (push-button type) on the control board of the outdoor unit. The compressor and ventilators (indoor and outdoor units) start operating (refrigerant collecting operation begins). (LED1 and LED2 on the control board of the outdoor unit are lit.)
 - Only push the pump-down SWP switch if the unit is stopped. However, even if the unit is stopped and the pump-down SWP switch is pushed less than 3 minutes after the compressor stops, the refrigerant collecting operation cannot be performed. Wait until the compressor has been stopped for 3 minutes and then push the pump-down SWP switch again.
- ⑥ Fully close the ball valve on the gas pipe side of the outdoor unit when the pressure gauge on the gauge manifold shows 0.05 to 0 MPa [Gauge] (approx. 0.5 to 0 kgf/cm²) and quickly stop the air conditioner.
 - Because the unit automatically stops in about 3 minutes when the refrigerant collecting operation is completed (LED1 off, LED2 lit), be sure to quickly close the gas ball valve. However, if LED1 is lit, LED2 is off, and the unit is stopped, open the liquid stop valve completely, close the valve completely after 3 minutes or more have passed, and then repeat step ⑤. (Open the gas ball valve completely.)
 - If the refrigerant collecting operation has been completed normally (LED1 off, LED2 lit), the unit will remain stopped until the power supply is turned off.
 - Note that it may not be possible to perform a pump-down operation when the extension piping is very long with a large refrigerant amount. In this case, use refrigerant recovery equipment to collect all of the refrigerant in the system.
- ⑦ Turn off the power supply (circuit breaker), remove the gauge manifold, and then disconnect the refrigerant pipes.

⚠ Warning:

When pumping down the refrigerant, stop the compressor before disconnecting the refrigerant pipes.

- **If the refrigerant pipes are disconnected while the compressor is operating and the stop valve (ball valve) is open, the pressure in the refrigeration cycle could become extremely high if air is drawn in, causing the pipes to burst, personal injury, etc.**
- **Do not perform pump down work when there is a gas leak. The intake of air or other gases causes abnormally high pressure in the refrigeration cycle, which may cause explosion or injury.**

9-2. START AND FINISH OF TEST RUN

- Operation from the indoor unit
Execute the test run using the installation manual for the indoor unit.

- Operation from the outdoor unit

By using the DIP switch SW4 on the control board of outdoor unit, test run can be started and finished, and its operation mode (cooling/heating) can be set up.

- ① Set the operation mode (cooling/heating) using SW4-2.
- ② Turn on SW4-1 to start test run with the operation mode set by SW4-2.
- ③ Turn off SW4-1 to finish the test run.

- There may be a faint knocking sound around the machine room after power is supplied. However, this is not a problem with product because the linear expansion valve is just moving to adjust opening pulse.
- There may be a knocking sound around the machine room for several seconds after compressor starts operating. However, this is not a problem with product because it is generated by the check valve itself due to a small pressure difference in the refrigerant circuit.

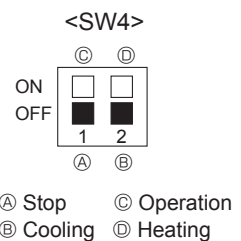

Note:

The operation cannot be changed by SW4-2 during test run. (To change test run mode, stop the unit by SW4-1, change the operation mode and restart the test run by SW4-1.)

10-1. TROUBLESHOOTING

<Check code displayed by self-diagnosis and actions to be taken for service (summary)>

Present and past check codes are logged, and they can be displayed on the control board of outdoor unit. Actions to be taken for service, which depends on whether or not the trouble is reoccurring in the field, are summarized in the table below. Check the contents below before investigating details.

Unit conditions at service	Check code	Actions to be taken for service (summary)
The trouble is reoccurring.	Displayed	Judge the problem and take a corrective action according to "10-3. SELF-DIAGNOSIS ACTION TABLE".
	Not displayed	Conduct troubleshooting and ascertain the cause of the trouble according to "10-4. TROUBLESHOOTING BY INFERIOR PHENOMENA".
The trouble is not reoccurring.	Logged	<ol style="list-style-type: none"> 1. Consider the temporary defects such as the work of protection devices in the refrigerant circuit including compressor, poor connection of wiring, noise, etc. Re-check the symptom, and check the installation environment, refrigerant amount, weather when the trouble occurred, matters related to wiring, etc. 2. Reset check code logs and restart the unit after finishing service. 3. There is no abnormality in electrical component, controller board, remote controller, etc.
	Not logged	<ol style="list-style-type: none"> 1. Re-check the abnormal symptom. 2. Conduct troubleshooting and ascertain the cause of the trouble according to "10-4. TROUBLESHOOTING BY INFERIOR PHENOMENA". 3. Continue to operate unit for the time being if the cause is not ascertained. 4. There is no abnormality concerning of parts such as electrical component, controller board, remote controller, etc.

10-2. CHECK POINT UNDER TEST RUN

10-2-1. Before test run

- After installation of indoor and outdoor units, piping work and electric wiring work, re-check that there is no refrigerant leakage, loosened connections and incorrect polarity.
 - Measure impedance between the ground and the power supply terminal block (L1, L2) on the outdoor unit by 500 V Megger and check that it is 1.0 MΩ or over.
 - Do not use 500 V Megger to indoor/outdoor connecting wire terminal block (S1, S2, S3) and remote controller terminal block (1, 2). This may cause malfunction.
 - Make sure that test run switch (SW4) is set to OFF before turning on power supply.
 - Turn on power supply 12 hours before test run in order to protect compressor.
 - For specific models which requires higher ceiling settings or auto-recovery feature from power failure, make proper changes of settings referring to the description of "12. FUNCTION SETTING".
- Make sure to read operation manual before test run. (Especially items to secure safety.)

10-2-2. TEST RUN

Refer to "15-4. TEST RUN" for operation procedure.

10-2-3. ERROR INFORMATION

Refer to "15-2. ERROR INFORMATION" when an error occurs.

10-2-4. ERROR HISTORY

Refer to "15-6. ERROR HISTORY" to check the errors occurred in the past.

10-2-5. SELF-DIAGNOSIS

Refer to "15-7. SELF-DIAGNOSIS" to search for the error history.

• Refer to the following tables for details on the check codes.

[Output pattern A]

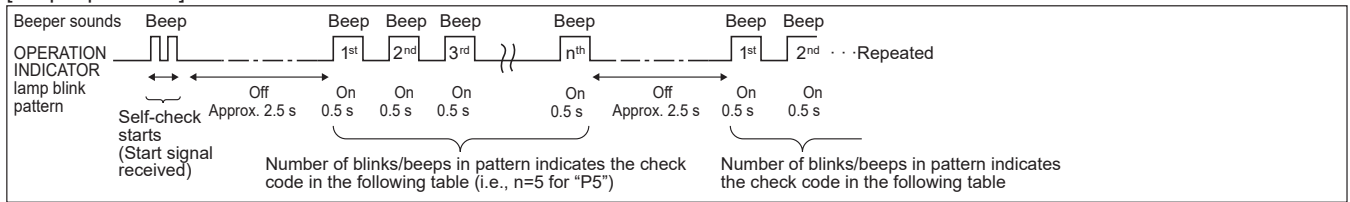

[Output pattern B]

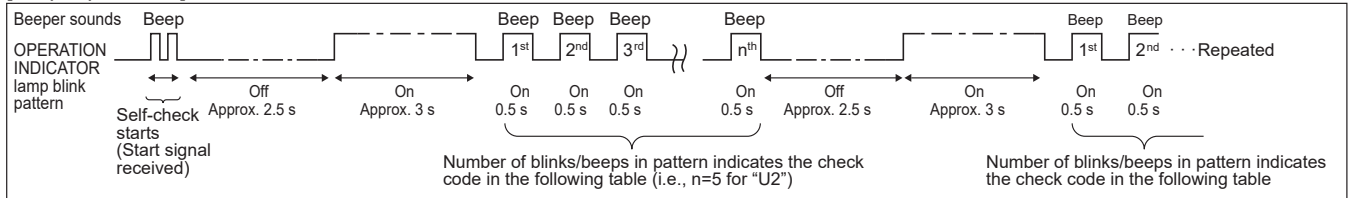

[Output pattern A] Errors detected by indoor unit

IR wireless remote controller		Wired remote controller	Symptom	Remark
Beeper sounds/OPERATION INDICATOR lamp blinks (Number of times)	① Check code			
1	P1		Intake sensor error	As for indoor unit, refer to indoor unit's service manual.
2	P2		Pipe (TH2) sensor error	
	P9		Pipe (TH5) sensor error	
3	E6, E7		Indoor/outdoor unit communication error	
4	P4		Drain sensor error/Float switch connector open	
5	P5		Drain pump error	
	PA		Forced compressor stop(due to water leakage abnormality)	
6	P6		Freezing/Overheating protection operation	
7	EE		Combination error between indoor and outdoor units	
8	P8		Pipe temperature error	
9	E4, E5		Remote controller signal receiving error	
10	—		—	
11	—		—	
12	FB (Fb)		Indoor unit control system error (memory error, etc.)	
14	PL		Abnormal refrigerant circuit	
—	E0, E3		Remote controller transmission error	
—	E1, E2		Remote controller control board error	

[Output pattern B] Errors detected by unit other than indoor unit (outdoor unit, etc.)

IR wireless remote controller		Wired remote controller	Symptom	Remark
Beeper sounds/OPERATION INDICATOR lamp blinks (Number of times)	Check code			
1	E9		Indoor/outdoor unit communication error (Transmitting error) (Outdoor unit)	For details, check the LED display of the outdoor controller board.
2	UP		Compressor overcurrent interruption	
3	U3,U4		Open/short of outdoor unit thermistors	
4	UF		Compressor overcurrent interruption (When compressor locked)	
5	U2		Abnormal high discharge temperature/49C worked/insufficient refrigerant	
6	U1,Ud		Abnormal high pressure (63H worked)/Overheating protection operation	
7	U5		Abnormal temperature of heatsink	
8	U8		Outdoor unit fan protection stop	
9	U6		Compressor overcurrent interruption/Abnormal of power module	
10	U7		Abnormality of super heat due to low discharge temperature	
11	U9,UH		Abnormality such as overvoltage or voltage shortage and abnormal synchronous signal to main circuit/Current sensor error	
12	—		—	
13	—		—	
14	Others		Other errors	

Notes:

1. If the beeper does not sound again after the initial 2 beeps to confirm the self-check start signal was received and the OPERATION INDICATOR lamp does not come on, there are no error records.
2. If the beeper sounds 3 times continuously "beep, beep, beep (0.4 + 0.4 + 0.4 s)" after the initial 2 beeps to confirm the self-check start signal was received, the specified refrigerant address is incorrect.

10-3. SELF-DIAGNOSIS ACTION TABLE

<Abnormalities detected when the power is turned on>

Note: Refer to indoor unit section for the codes starting with P and E.

Check Code	Abnormal point and detection method	Cause	Judgment and action
None	—	<p>① No voltage is supplied to terminal block(TB1) of outdoor unit. a) Power supply breaker is turned off. b) Contact failure or disconnection of power supply terminal c) Open phase (L1 or L2 phase)</p> <p>② Electric power is not charged to power supply terminal of outdoor power circuit board. a) Contact failure of power supply terminal b) Open phase on the outdoor power circuit board Disconnection of connector LI or NI</p> <p>③ Electric power is not supplied to outdoor controller circuit board. a) Disconnection of connector (CNDC)</p> <p>④ Disconnection of reactor (DCL)</p> <p>⑤ Defective outdoor power circuit board</p> <p>⑥ Defective outdoor controller circuit board</p>	<p>① Check following items. a) Power supply breaker b) Connection of power supply terminal block (TB1) c) Connection of power supply terminal block (TB1)</p> <p>② Check following items. a) Connection of power supply terminal block (TB1) b) Connection of terminal on outdoor power circuit board Disconnection of connector LI or NI Refer to "10-8. TEST POINT DIAGRAM".</p> <p>③ Check connection of the connector (CNDC) on the outdoor controller circuit board. Check connection of the connector, CNDC, on the outdoor power circuit board. Refer to "10-8. TEST POINT DIAGRAM".</p> <p>④ Check connection of reactor. (DCL) Refer to "7. WIRING DIAGRAM".</p> <p>⑤ Replace outdoor power circuit board.</p> <p>⑥ Replace controller board (When items above are checked but the units cannot be repaired).</p>

Check Code	Abnormal point and detection method	Cause	Judgment and action
F5 (5201)	63H connector open Abnormal if 63H connector circuit is open for 3 minutes continuously after power supply. 63H: High pressure switch	<ul style="list-style-type: none"> ① Disconnection or contact failure of 63H connector on outdoor controller circuit board ② Disconnection or contact failure of 63H ③ 63H is working due to defective parts. ④ Defective outdoor controller circuit board 	<ul style="list-style-type: none"> ① Check connection of 63H connector on outdoor controller circuit board. Refer to "10-8. TEST POINT DIAGRAM". ② Check the 63H side of connecting wire. ③ Check continuity by tester. Replace the parts if the parts are defective. ④ Replace outdoor controller circuit board.
EA (6844)	Miswiring of indoor/outdoor unit connecting wire 1. Outdoor controller circuit board can automatically check the number of connected indoor units. Abnormal if the number cannot be checked automatically due to miswiring of indoor/outdoor unit connecting wire, etc. after power is turned on for 4 minutes. 2. Abnormal if outdoor controller circuit board recognizes excessive number of indoor units.	<ul style="list-style-type: none"> ① Contact failure or miswiring of indoor/outdoor unit connecting wire ② Diameter or length of indoor/outdoor unit connecting wire is out of specified capacity. ③ Excessive number of indoor units are connected to 1 outdoor unit. (4 units or more) ④ Defective transmitting receiving circuit of outdoor controller circuit board ⑤ Defective transmitting receiving circuit of indoor controller board ⑥ Defective indoor power board ⑦ 2 or more outdoor units have refrigerant address "0" . (In the case of group control) ⑧ Noise has entered into power supply or indoor / outdoor unit connecting wire. 	<ul style="list-style-type: none"> ① Check disconnection or looseness or polarity of indoor/outdoor unit connecting wire of indoor and outdoor units. ② Check diameter and length of indoor/outdoor unit connecting wire. Total wiring length: 80m (including wiring connecting each indoor unit and between indoor and outdoor unit) Also check if the connection order of flat cable is S1, S2, S3. ③ Check the number of indoor units that are connected to one outdoor unit. (If EA is detected) ④-⑥ Turn the power off once, and on again to check. Replace outdoor controller circuit board, indoor controller board or indoor power board if abnormality occurs again.
Eb (6845)	Miswiring of indoor/outdoor unit connecting wire (converse wiring or disconnection) Outdoor controller circuit board can automatically set the unit number of indoor units. Abnormal if the indoor unit number cannot be set within 4 minutes after power on because of miswiring (converse wiring or disconnection) of indoor/outdoor unit connecting wire.	<ul style="list-style-type: none"> ① Contact failure or miswiring of indoor/outdoor unit connecting wire ② Diameter or length of indoor/outdoor unit connecting wire is out of specified capacity. ④ Defective transmitting receiving circuit of outdoor controller circuit board ⑤ Defective transmitting receiving circuit of indoor controller board ⑥ Defective indoor power board ⑦ 2 or more outdoor units have refrigerant address "0" . (In the case of group control) ⑧ Noise has entered into power supply or indoor/outdoor unit connecting wire. 	<ul style="list-style-type: none"> ⑦ Check if refrigerant addresses (SW1-3 to SW1-6 on outdoor controller circuit board) are overlapping in the case of group control system. ⑧ Check transmission path, and remove the cause. <p>Note: The descriptions above 1-8 are for EA, Eb and EC.</p>
EC (6846)	Startup time over The unit cannot finish startup process within 4 minutes after power on.	<ul style="list-style-type: none"> ① Contact failure of indoor/outdoor unit connecting wire ② Diameter or length of indoor/outdoor unit connecting wire is out of specified capacity. ⑦ 2 or more outdoor units have refrigerant address "0" . (In the case of group control) ⑧ Noise has entered into power supply or indoor/outdoor unit connecting wire. 	

<Abnormalities detected while unit is operating>

Check Code	Abnormal point and detection method	Cause	Judgment and action
<p>U1 (1302)</p>	<p>High pressure (High pressure switch 63H worked) Abnormal if high pressure switch 63H worked (*) during compressor operation. *4.15 MPa [602PSIG]</p> <p>63H: High pressure switch</p>	<p>① Short cycle of indoor unit ② Clogged filter of indoor unit ③ Decreased airflow caused by dirt of indoor fan ④ Dirt of indoor heat exchanger ⑤ Locked indoor fan motor ⑥ Malfunction of indoor fan motor ⑦ Defective operation of stop valve (Not full open) ⑧ Clogged or broken pipe ⑨ Locked outdoor fan motor ⑩ Malfunction of outdoor fan motor ⑪ Short cycle of outdoor unit ⑫ Dirt of outdoor heat exchanger ⑬ Decreased airflow caused by defective inspection of outside temperature thermistor (It detects lower temperature than actual temperature.) ⑭ Disconnection or contact failure of connector (63H) on outdoor controller board ⑮ Disconnection or contact failure of 63H connection ⑯ Defective outdoor controller board ⑰ Defective action of linear expansion valve ⑱ Malfunction of fan driving circuit</p>	<p>①-⑥ Check indoor unit and repair defect. ⑦ Check if stop valve is fully open. ⑧ Check piping and repair defect. ⑨-⑫ Check outdoor unit and repair defect. ⑬ Check the detected temperature of outside temperature thermistor on LED display. (SW2 on A-Control Service Tool: Refer to "10-9. FUNCTION OF SWITCHES, CONNECTORS AND JUMPERS".) ⑭-⑯ Turn the power off and check F5 is displayed when the power is on again. When F5 is displayed, refer to "Judgment and action" for F5. ⑰ Check linear expansion valve. Refer to "10-5. HOW TO CHECK THE PARTS". ⑱ Replace outdoor controller board.</p>
<p>U2 (1102)</p>	<p>High discharge temperature (1) Abnormal if TH4 exceeds 257°F [125°C] or 230°F [110°C] continuously for 5 minutes. Abnormal if TH4 exceeds 230°F [110°C] or more continuously for 30 seconds after 90 seconds have passed since the defrosting operation started. (2) Abnormal if discharge superheat (Cooling: TH4-T_{63HS} / Heating: TH4-T_{63HS}) exceeds 126°F [70°C] continuously for 10 minutes. TH4: Thermistor <Discharge></p> <p>High comp. surface temperature Abnormal if TH33 exceeds 257°F [125°C]. In the case of high comp. surface temperature error, compressor does not restart unless the thermistor (TH33) becomes less than 203°F [95°C]. TH33: Thermistor <Comp. surface></p>	<p>① Overheated compressor operation caused by shortage of refrigerant ② Defective operation of stop valve ③ Defective thermistor ④ Defective outdoor controller board ⑤ Defective action of linear expansion valve ⑥ Clogging with foreign objects in refrigerant circuit Note: Clogging occur in the parts which become below freezing point when water enters in refrigerant circuit. ⑦ In the case of the unit does not restart: Detection temp. of thermistor (TH33)] 203°F [95°C]</p>	<p>① Check intake superheat. Check leakage of refrigerant. Charge additional refrigerant. ② Check if stop valve is fully open. ③④ Turn the power off and check if U3 is displayed when the power is turned on again. When U3 is displayed, refer to "Judgement and action" for U3. ⑤ Check linear expansion valve. Refer to "10-5. HOW TO CHECK THE PARTS". ⑥ After recovering refrigerant, remove water from entire refrigerant circuit under vacuum more than 1 hour.</p>

Check Code	Abnormal point and detection method	Cause	Judgment and action																						
U3 (5104)	Open/short circuit of outdoor unit temperature thermistor (TH4, TH33) Abnormal if open (37°F [3°C] or less) or short (422°F [217°C] or more) is detected during compressor operation. (Detection is inoperative for 10 minutes of compressor starting process and for 10 minutes after and during defrosting.) TH4: Thermistor <Discharge> TH33: Thermistor <Comp. surface>	① Disconnection or contact failure of connectors (TH4, TH33) on the outdoor controller circuit board ② Defective thermistor ③ Defective outdoor controller circuit board	① Check connection of connector (TH4, TH33) on the outdoor controller circuit board. Check breaking of the lead wire for TH4, TH33. Refer to "10-8. TEST POINT DIAGRAM". ② Check resistance value of TH4, TH33 or temperature by microprocessor. (Thermistor/TH4, TH33: Refer to "10-5. HOW TO CHECK THE PARTS".) (SW2 on A-Control Service Tool: Refer to "10-9. FUNCTION OF SWITCHES, CONNECTORS AND JUMPERS".) ③ Replace outdoor controller board.																						
U4 (TH3: 5105) (TH6: 5107) (TH7: 5106) (TH8: 5110) (TH32: 5105)	Open/short of outdoor unit thermistors (TH3, TH32, TH6, TH7, and TH8) Abnormal if open or short is detected during compressor operation. Open detection of TH3, TH32 and TH6 is inoperative for 10 seconds to 10 minutes after compressor starting and 10 minutes after and during defrosting. Note: Check which unit has abnormality in its thermistor by switching the mode of SW2. (PAC-SK52ST) (Refer to "10-9. FUNCTION OF SWITCHES, CONNECTORS AND JUMPERS".)	① Disconnection or contact failure of connectors Outdoor controller circuit board: (TH3, TH32, TH7/6) Outdoor power circuit board: (CN6) ② Defective thermistor ③ Defective outdoor controller circuit board	① Check connection of connector (TH3, TH32, TH7/6) on the outdoor controller circuit board. Check connection of connector (CN6) on the outdoor power circuit board. Check breaking of the lead wire for TH3, TH32, TH6, TH7, TH8. Refer to "10-8. TEST POINT DIAGRAM". ② Check resistance value of TH3, TH32, TH6, TH7, TH8 or check temperature by microprocessor. (TH3,TH6,TH7,TH8: Refer to "10-5. HOW TO CHECK THE PARTS".) (SW2 on A-Control Service Tool: Refer to "10-9. FUNCTION OF SWITCHES, CONNECTORS AND JUMPERS".) ③ Replace outdoor controller circuit board. Note: Emergency operation is available in the case of abnormalities of TH3, TH32, TH6 and TH7. Refer to "10-7. EMERGENCY OPERATION".																						
<table border="1"> <thead> <tr> <th colspan="2">Thermistors</th> <th rowspan="2">Open detection</th> <th rowspan="2">Short detection</th> </tr> <tr> <th>Symbol</th> <th>Name</th> </tr> </thead> <tbody> <tr> <td>TH3, TH32</td> <td>Thermistor <Liquid>, <Suction></td> <td>-54°F [-48°C] or below</td> <td>194°F [90°C] or above</td> </tr> <tr> <td>TH6</td> <td>Thermistor <2-phase pipe></td> <td>-54°F [-48°C] or below</td> <td>194°F [90°C] or above</td> </tr> <tr> <td>TH7</td> <td>Thermistor <Ambient></td> <td>-54°F [-48°C] or below</td> <td>194°F [90°C] or above</td> </tr> <tr> <td>TH8</td> <td>Thermistor <Heatsink></td> <td>-54°F [-48°C] or below</td> <td>216°F [102°C] or above</td> </tr> </tbody> </table>				Thermistors		Open detection	Short detection	Symbol	Name	TH3, TH32	Thermistor <Liquid>, <Suction>	-54°F [-48°C] or below	194°F [90°C] or above	TH6	Thermistor <2-phase pipe>	-54°F [-48°C] or below	194°F [90°C] or above	TH7	Thermistor <Ambient>	-54°F [-48°C] or below	194°F [90°C] or above	TH8	Thermistor <Heatsink>	-54°F [-48°C] or below	216°F [102°C] or above
Thermistors		Open detection	Short detection																						
Symbol	Name																								
TH3, TH32	Thermistor <Liquid>, <Suction>	-54°F [-48°C] or below	194°F [90°C] or above																						
TH6	Thermistor <2-phase pipe>	-54°F [-48°C] or below	194°F [90°C] or above																						
TH7	Thermistor <Ambient>	-54°F [-48°C] or below	194°F [90°C] or above																						
TH8	Thermistor <Heatsink>	-54°F [-48°C] or below	216°F [102°C] or above																						
U5 (4230)	Temperature of heatsink Abnormal if heat sink thermistor(TH8) detects temperature indicated below. KA24 170°F [77°C] KA30/36 177°F [81°C]	① The outdoor fan motor is locked. ② Failure of outdoor fan motor ③ Airflow path is clogged. ④ Rise of ambient temperature ⑤ Defective thermistor ⑥ Defective input circuit of outdoor power circuit board ⑦ Failure of outdoor fan drive circuit	①② Check outdoor fan. ③ Check airflow path for cooling. ④ Check if there is something which causes temperature rise around outdoor unit. (Upper limit of ambient temperature is 114°F [46°C].) Turn off power, and on again to check if U5 is displayed within 30 minutes. If U4 is displayed instead of U5, follow the action to be taken for U4. ⑤ Check resistance value of thermistor (TH8) or temperature by microprocessor. (Thermistor/TH8: Refer to "10-5. HOW TO CHECK THE PARTS".) (SW2 on A-Control Service Tool: Refer to "10-9. FUNCTION OF SWITCHES, CONNECTORS AND JUMPERS".) ⑥ Replace outdoor power circuit board. ⑦ Replace outdoor controller circuit board.																						
U6 (4250)	Power module Check abnormality by driving power module in case overcurrent is detected. (UF or UP error condition)	① Outdoor stop valve is closed. ② Decrease of power supply voltage ③ Looseness, disconnection or converse of compressor wiring connection ④ Defective compressor ⑤ Defective outdoor power circuit board	① Open stop valve. ② Check facility of power supply. ③ Correct the wiring (U·V·W phase) to compressor. Refer to "10-8. TEST POINT DIAGRAM" (Outdoor power circuit board). ④ Check compressor referring to "10-5. HOW TO CHECK THE PARTS". ⑤ Replace outdoor power circuit board.																						

Check Code	Abnormal point and detection method	Cause	Judgment and action	
U7 (1502)	Too low superheat due to low discharge temperature Abnormal if discharge superheat is continuously detected less than or equal to 5°F [-15°C] for 3 minutes even though linear expansion valve has minimum open pulse after compressor starts operating for 10 minutes.	① Disconnection or loose connection of discharge temperature thermistor (TH4) ② Defective holder of discharge temperature thermistor ③ Disconnection or loose connection of linear expansion valve's coil ④ Disconnection or loose connection of linear expansion valve's connector ⑤ Defective linear expansion valve	①② Check the installation conditions of discharge temperature thermistor (TH4). ③ Check the coil of linear expansion valve. Refer to "10-6. HOW TO CHECK THE COMPONENTS". ④ Check the connection or contact of LEV-A and LEV-B on outdoor controller circuit board. ⑤ Check linear expansion valve. Refer to "10-5. HOW TO CHECK THE PARTS".	
U8 (4400)	Outdoor fan motor Abnormal if rotational frequency of the fan motor is not detected during DC fan motor operation. Fan motor rotational frequency is abnormal if; • 100 rpm or below detected continuously for 15 seconds at 68°F [20°C] or more outside air temperature. • 50 rpm or below or 1500 rpm or more detected continuously for 1 minute.	① Failure in the operation of the DC fan motor ② Failure in the outdoor circuit controller board	① Check or replace the DC fan motor. ② Check the voltage of the outdoor circuit controller board during operation. ③ Replace the outdoor circuit controller board. (when the failure is still indicated even after performing the remedy ① above.)	
U9 (4220)	Detailed codes	To find out the detail history (latest) about U9 error, turn ON SW2-1, 2-2 and 2-6. Refer to "10-9. FUNCTION OF SWITCHES, CONNECTORS AND JUMPERS".		
	01	Overvoltage error • Increase in DC bus voltage to 430 V	① Abnormal increase in power source voltage ② Disconnection of compressor wiring ③ Defective outdoor power circuit board ④ Compressor has a ground fault.	① Check the field facility for the power supply. ② Correct the wiring (U-V-W phase) to compressor. Refer to "10-8. TEST POINT DIAGRAM" (Outdoor power circuit board). ③ Replace outdoor power circuit board. ④ Check compressor for electrical insulation. Replace compressor.
	02	Undervoltage error • Instantaneous decrease in DC bus voltage to 200 V	① Decrease in power source voltage, instantaneous stop. ② Defective converter drive circuit in outdoor power circuit board ③ Defective 52C drive circuit in outdoor power circuit board ④ Disconnection or loose connection of CN2 on the outdoor power circuit board / controller circuit board ⑤ Power circuit failure on DC supply for 15 VDC output on outdoor controller circuit board	① Check the field facility for the power supply. ② Replace outdoor power circuit board. ③ Replace outdoor power circuit board. ④ Check CN2 wiring. ⑤ Replace outdoor controller circuit board.
	04	Input current sensor error • Decrease in input current through outdoor unit to 0.5 A only if operation frequency is more than or equal to 40 Hz or compressor current is more than or equal to 6 A.	① Defective input current detection circuit in outdoor power circuit board ② Defective outdoor controller circuit board	① Replace outdoor power circuit board. ② Replace outdoor controller circuit board.

Check Code	Abnormal point and detection method	Cause	Judgment and action
U9 (4220)	Detailed codes	Abnormal power synchronous signal • No input of power synchronous signal to power circuit board • Power synchronous signal of 44 Hz or less, or 65 Hz or more is detected on power circuit board.	① Distortion of power source voltage, noise superimposition ② Disconnection or loose connection of earth wiring ③ Disconnection or loose connection of CN2 on the outdoor power circuit board / controller circuit board ④ Defective power synchronous signal circuit in outdoor controller circuit board ⑤ Defective power synchronous signal circuit in outdoor power circuit board
	08		
10	PFC error (Overvoltage/Undervoltage/Overcurrent) • PFC detected any of the following: a) Increase of DC bus voltage as follows: 430 V b) Decrease in PFC control voltage to 13 VDC or lower c) Increase in input current as follows. KA24: 42 A peak KA30/36: 62 A peak	① Abnormal increase in power source voltage ② Decrease in power source voltage, instantaneous stop ③ Disconnection of compressor wiring ④ Misconnection of reactor (DCL) ⑤ Defective outdoor power circuit board ⑥ Defective reactor (DCL) ⑦ Disconnection or loose connection of CN2 on the outdoor power circuit board / controller circuit board	①② Check the field facility for the power supply. ③ Correct the wiring (U·V·W phase) to compressor. Refer to "10-8. TEST POINT DIAGRAM". ④ Correct the wiring (U·V·W phase) or reactor (DCL). ⑤ Replace outdoor power circuit board. ⑥ Replace reactor (DCL). ⑦ Check CN2 wiring.
UF (4100)	Compressor overcurrent interruption (When compressor locked) Abnormal if overcurrent of DC bus or compressor is detected within 30 seconds after compressor starts operating.	① Stop valve is closed. ② Decrease of power supply voltage ③ Looseness, disconnection or converse of compressor wiring connection ④ Defective compressor ⑤ Defective outdoor power board ⑥ DIP switch setting difference of outdoor controller circuit board.	① Open stop valve. ② Check facility of power supply. ③ Correct the wiring (U·V·W phase) to compressor. Refer to "10-8. TEST POINT DIAGRAM" (Outdoor power circuit board). ④ Check compressor. Refer to "10-5. HOW TO CHECK THE PARTS". ⑤ Replace outdoor power circuit board. ⑥ Check the dip switch setting of outdoor controller circuit board. Refer to "Model Select" in "1) Function of switches" in "10-9. FUNCTION OF SWITCHES, CONNECTORS AND JUMPERS".
UH (5300)	Current sensor error • It is abnormal for 38 A the input current or 10 seconds continuous 34 A or more.	① Defective circuit of current sensor on outdoor power circuit board ② Decrease of power supply voltage	① Replace outdoor power circuit board. ② Check the facility of power supply.
Ud (1504)	Overheat protection Abnormal if outdoor pipe thermistor (TH3), condensing temperature T _{63HS} detects 158°F [70°C] or more during compressor operation.	① Defective outdoor fan (fan motor) or short cycle of outdoor unit during cooling operation ② Defective outdoor pipe thermistor (TH3), condensing temperature T _{63HS} ③ Defective outdoor controller board	① Check outdoor unit air passage. ②③ Turn the power off and on again to check the check code. If U4 is displayed, follow the U4 processing direction.
UE (1302)	Abnormal pressure of 63HS Abnormal if 63HS detects 14.5 PSIG [0.1 MPa] or less. Detection is inoperative for 3 minutes after compressor starting and 3 minutes after and during defrosting. 63HS: High pressure sensor	① Disconnection or contact failure of connector (63HS) on the outdoor controller circuit board ② Defective pressure sensor ③ Defective outdoor controller circuit board	① Check connection of connector (63HS) on the outdoor controller circuit board. Check breaking of the lead wire for 63HS. ② Check pressure by microprocessor. (Pressure sensor/ 63HS) (SW2: Refer to "10-9. FUNCTION OF SWITCHES, CONNECTORS AND JUMPERS".) ③ Replace outdoor controller board.

Check Code	Abnormal point and detection method	Cause	Judgment and action
UL (1300)	Abnormal low pressure (63L worked) Abnormal if 63L is worked (under -4 PSIG [-0.03 MPa]) during compressor operation. 63L: Low pressure switch	<ul style="list-style-type: none"> ① Stop valve of outdoor unit is closed during operation. ② Disconnection or loose connection of connector (63L) on outdoor controller board ③ Disconnection or loose connection of 63L ④ Defective outdoor controller board ⑤ Leakage or shortage of refrigerant ⑥ Malfunction of linear expansion valve 	<ul style="list-style-type: none"> ① Check stop valve. ②-④ Turn the power off and on again to check if F3 is displayed on restarting. If F3 is displayed, follow the F3 processing direction. ⑤ Correct to proper amount of refrigerant. ⑥ Check linear expansion valve. Refer to "10-5. HOW TO CHECK THE PARTS".
UP (4210)	Compressor overcurrent interruption Abnormal if overcurrent DC bus or compressor is detected after compressor starts operating for 30 seconds.	<ul style="list-style-type: none"> ① Stop valve of outdoor unit is closed. ② Decrease of power supply voltage ③ Looseness, disconnection or converse of compressor wiring connection ④ Defective fan of indoor/outdoor units ⑤ Short cycle of indoor/outdoor units ⑥ Defective input circuit of outdoor controller board ⑦ Defective compressor ⑧ Defective outdoor power circuit board ⑨ Dip switch setting difference of outdoor controller circuit board 	<ul style="list-style-type: none"> ① Open stop valve. ② Check facility of power supply. ③ Correct the wiring (U-V-W phase) to compressor. Refer to "10-8. TEST POINT DIAGRAM". (Outdoor power circuit board). ④ Check indoor/outdoor fan. ⑤ Solve short cycle. ⑥ Replace outdoor controller circuit board. ⑦ Check compressor. Refer to "10-5. HOW TO CHECK THE PARTS". <p>Before the replacement of the outdoor controller circuit board, disconnect the wiring to compressor from the outdoor power circuit board and check the output voltage among phases, U, V, W, during test run. No defect on board if voltage among phases (U-V, V-W and W-U) is same. Make sure to perform the voltage check with same performing frequency.</p> <ul style="list-style-type: none"> ⑧ Replace outdoor power circuit board ⑨ Check the dip switch setting of outdoor controller circuit board
E0 or E4	Remote controller transmission error(E0)/signal receiving error(E4) <ul style="list-style-type: none"> ① Abnormal if main or sub remote controller cannot receive normally any transmission from indoor unit of refrigerant address "0" for 3 minutes. (Check code: E0) ② Abnormal if sub-remote controller could not receive any signal for 2 minutes. (Check code: E0) ① Abnormal if indoor controller board can not receive any data normally from remote controller board or from other indoor controller board for 3 minutes. (Check code: E4) ② Indoor controller board cannot receive any signal from remote controller for 2 minutes. (Check code: E4) 	<ul style="list-style-type: none"> ① Contact failure at transmission wire of remote controller ② All remote controllers are set as "sub" remote controller. In this case, E0 is displayed on remote controller, and E4 is displayed at LED (LED1, LED2) on the outdoor controller circuit board. ③ Miswiring of remote controller ④ Defective transmitting receiving circuit of remote controller ⑤ Defective transmitting receiving circuit of indoor controller board of refrigerant address "0". ⑥ Noise has entered into the transmission wire of remote controller. 	<ul style="list-style-type: none"> ① Check disconnection or looseness of indoor unit or transmission wire of remote controller. ② Set one of the remote controllers "main". If there is no problem with the action above. ③ Check wiring of remote controller. <ul style="list-style-type: none"> • Total wiring length: max. 1640 ft [500 m] (Do not use cable with 3 or more cores.) • The number of connecting indoor units: max. 16 units • The number of connecting remote controller: max. 2 units <p>If the cause of trouble is not any of ①-③ above, diagnose ④-⑥ by remote controllers.</p> <ul style="list-style-type: none"> a) When "OK" is displayed, remote controllers have no problem. Turn the power off, and on again to check. If abnormality occurs again, replace indoor controller board. b) When "NG" is displayed, replace remote controller. c) When "E3" or "ERC" is displayed, noise may be causing abnormality. <p>Note: If the unit is not normal after replacing indoor controller board in group control, indoor controller board of address "0" may be abnormal.</p>
E1 or E2	Remote controller control board <ul style="list-style-type: none"> ① Abnormal if data cannot be read normally from the nonvolatile memory of the remote controller control board. (Check code: E1) ② Abnormal if the clock function of remote controller cannot be operated normally. (Check code: E2) 	<ul style="list-style-type: none"> ① Defective remote controller 	<ul style="list-style-type: none"> ① Replace remote controller.

Check Code	Abnormal point and detection method	Cause	Judgment and action
E3 or E5	<p>Remote controller transmission error(E3)/signal receiving error(E5)</p> <p>① Abnormal if remote controller could not find blank of transmission path for 6 seconds and could not transmit. (Check code: E3)</p> <p>② Remote controller receives transmitted data at the same time, compares the data, and when detecting it, judges different data to be abnormal 30 continuous times. (Check code: E3)</p> <p>① Abnormal if indoor controller board could not find blank of transmission path. (Check code: E5)</p> <p>② Indoor controller board receives transmitted data at the same time, compares the data, and when detecting it, judges different data to be abnormal 30 continuous times. (Check code: E5)</p>	<p>① 2 remote controllers are set as "main." (In the case of 2 remote controllers)</p> <p>② Remote controller is connected with 2 indoor units or more.</p> <p>③ Repetition of refrigerant address</p> <p>④ Defective transmitting receiving circuit of remote controller</p> <p>⑤ Defective transmitting receiving circuit of indoor controller board</p> <p>⑥ Noise has entered into transmission wire of remote controller.</p>	<p>① Set a remote controller to main, and the other to sub.</p> <p>② Remote controller is connected with only one indoor unit.</p> <p>③ The address changes to a separate setting.</p> <p>④-⑥ Diagnose remote controller.</p> <p>a) When "OK" is displayed, remote controllers have no problem. Turn the power off, and on again to check. When becoming abnormal again, replace indoor controller board.</p> <p>b) When "NG" is displayed, replace remote controller.</p> <p>c) When "E3" or "ERC" is displayed, noise may be causing abnormality.</p>
E6 (6840)	<p>Indoor/outdoor unit communication error (Signal receiving error)</p> <p>① Abnormal if indoor controller board could not receive any signal normally for 6 minutes after turning the power on.</p> <p>② Abnormal if indoor controller board could not receive any signal normally for 3 minutes.</p> <p>③ Consider the unit as abnormal under the following condition When 2 or more indoor units are connected to an outdoor unit, indoor controller board could not receive a signal for 3 minutes from outdoor controller circuit board, a signal which allows outdoor controller circuit board to transmit signals.</p>	<p>① Contact failure, short circuit or miswiring (converse wiring) of indoor/outdoor unit connecting wire</p> <p>② Defective transmitting receiving circuit of outdoor controller circuit board.</p> <p>③ Defective transmitting receiving circuit of indoor controller board.</p> <p>④ Noise has entered into indoor/outdoor unit connecting wire.</p> <p>⑤ Defective fan motor</p> <p>⑥ Defective rush current resistor of outdoor power circuit board.</p>	<p>Note: Check LED display on outdoor controller circuit board. (Connect A-Control service tool (PAC-SG50ST))</p> <p>Refer to EA-EC item if LED displays EA-AC.</p> <p>① Check disconnecting or looseness of indoor/outdoor unit connecting wire of indoor unit or outdoor unit. Check all the units in the case of twin indoor unit system.</p> <p>②-④ Turn the power off, and on again to check. If abnormality occurs again, replace indoor controller board or outdoor controller circuit board.</p> <p>⑤ Turn the power off, and detach fan motor from connector (CNF1,2). Then turn the power on again. If abnormality is not displayed, replace fan motor. If abnormality is displayed, replace outdoor controller circuit board.</p> <p>⑥ Check the rush current resistor on outdoor noise filter board with a tester. If open is detected, replace the power board.</p> <p>Note: Other indoor controller board may have defect in the case of twin indoor unit system.</p>
E7	<p>Indoor/outdoor unit communication error (Transmitting error)</p> <p>Abnormal if "1" receiving is detected 30 times continuously though indoor controller board has transmitted "0".</p>	<p>① Defective transmitting receiving circuit of indoor controller board</p> <p>② Noise has entered into power supply.</p> <p>③ Noise has entered into outdoor control wire.</p>	<p>①-③ Turn the power off, and on again to check. Replace indoor controller board if abnormality is displayed again.</p>
E8 (6840)	<p>Indoor/outdoor unit communication error (Signal receiving error) (Outdoor unit)</p> <p>Abnormal if outdoor controller circuit board could not receive anything normally for 3 minutes.</p>	<p>① Contact failure of indoor/outdoor unit connecting wire</p> <p>② Defective communication circuit of outdoor controller circuit board</p> <p>③ Defective communication circuit of indoor controller board</p> <p>④ Noise has entered into indoor/outdoor unit connecting wire.</p>	<p>① Check disconnection or looseness of indoor/outdoor unit connecting wire of indoor or outdoor units.</p> <p>②-④ Turn the power off, and on again to check. Replace indoor controller board or outdoor controller circuit board if abnormality is displayed again.</p>
E9 (6841)	<p>Indoor/outdoor unit communication error (Transmitting error) (Outdoor unit)</p> <p>① Abnormal if "0" receiving is detected 30 times continuously though outdoor controller circuit board has transmitted "1".</p> <p>② Abnormal if outdoor controller circuit board could not find blank of transmission path for 3 minutes.</p>	<p>① Indoor/outdoor unit connecting wire has contact failure.</p> <p>② Defective communication circuit of outdoor controller circuit board</p> <p>③ Noise has entered power supply.</p> <p>④ Noise has entered indoor/outdoor unit connecting wire.</p>	<p>① Check disconnection or looseness of indoor/outdoor unit connecting wire.</p> <p>②-④ Turn the power off, and on again to check. Replace outdoor controller circuit board if abnormality is displayed again.</p>

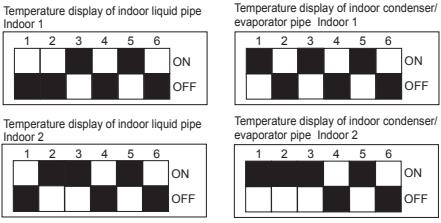
Check Code	Abnormal point and detection method	Cause	Judgment and action
EF (6607 or 6608)	Non defined check code This code is displayed when non-defined check code is received.	① Noise has entered transmission wire of remote controller. ② Noise has entered indoor/ outdoor unit connecting wire. ③ Outdoor unit is not inverter model.	①② Turn the power off, and on again to check. Replace indoor controller board or outdoor controller circuit board if abnormality is displayed again. ③ Replace outdoor unit with power inverter type.
Ed (0403)	Serial communication error 1. Abnormal if serial communication between outdoor controller circuit board and outdoor power circuit board is defective.	① Breaking of wire or contact failure of connector CN2 between the outdoor controller circuit board and the outdoor power circuit board ② Breaking of wire or contact failure of connector CN4 between the outdoor controller circuit board and the outdoor power circuit board ③ Defective communication circuit of outdoor power circuit board ④ Defective communication circuit of outdoor controller circuit board for outdoor power circuit board	①② Check connection of each connector CN2 and CN4 between the outdoor controller circuit board and the outdoor power circuit board. ③ Replace outdoor power circuit board. ④ Replace outdoor controller circuit board.
	2. Abnormal if communication between outdoor controller circuit board and M-NET board is not available.	① Breaking of wire or contact failure of connector between outdoor controller circuit board and M-NET board ② Contact failure of M-NET board power supply line ③ Noise has entered into M-NET transmission wire.	① Check disconnection, looseness, or breaking of connection wire between outdoor controller circuit board (CNMNT) and M-NET board (CN5). ② Check disconnection, looseness, or breaking of connection wire between outdoor controller circuit board (CNVMNT) and M-NET board (CND). ③ Check M-NET transmission wiring method.
P8	Pipe temperature <Cooling mode> Detected as abnormal when the pipe temperature is not in the cooling range 3 minutes after compressor start and 6 minutes after the liquid or condenser/evaporator pipe is out of cooling range. Note 1: It takes at least 9 minutes to detect. Note 2: Abnormality P8 is not detected in drying mode. Cooling range: Indoor pipe temperature (TH2 or TH5)-room temperature (TH1) $\leq -5.4^{\circ}\text{F} [-3^{\circ}\text{C}]$ TH: Lower temperature between liquid pipe temperature and condenser/evaporator temperature <Heating mode> When 10 seconds have passed after the compressor starts operation and the hot adjustment mode has finished, the unit is detected as abnormal when condenser/evaporator pipe temperature is not in heating range within 20 minutes. Note 3: It takes at least 27 minutes to detect abnormality. Note 4: It excludes the period of defrosting (Detection restarts when defrosting mode is over) Heating range: $-5.4^{\circ}\text{F} [-3^{\circ}\text{C}] \leq (\text{Condenser/Evaporator temperature(TH5)-room temperature(TH1)})$	① Slight temperature difference between indoor room temperature and pipe <liquid or condenser/evaporator> temperature thermistor • Shortage of refrigerant • Disconnected holder of pipe <liquid or condenser/evaporator> thermistor • Defective refrigerant circuit ② Converse connection of extension pipe (on plural units connection) ③ Converse wiring of indoor/outdoor unit connecting wire (on plural units connection) ④ Defective detection of indoor room temperature and pipe <condenser/evaporator> temperature thermistor ⑤ Stop valve is not opened completely.	①-④ Check pipe <liquid or condenser/evaporator> temperature with room temperature display on remote controller and outdoor controller circuit board. Pipe <liquid or condenser/evaporator> temperature display is indicated by setting SW2 of outdoor controller circuit board as follows. (Conduct temperature check with outdoor controller circuit board after connecting 'A-Control Service Tool (PAC-SK52ST)')  <p style="text-align: center;">A-Control Service Tool SW2 setting</p> ②③ Check converse connection of extension pipe or converse wiring of indoor/outdoor unit connecting wire. ⑤ Check the stop valve is opened completely.

Check Code	Abnormal point and detection method	Cause	Judgment and action
PL	<p>Abnormal refrigerant circuit During Cooling, Dry, or Auto Cooling operation, the following conditions are regarded as failures when detected for 1 second.</p> <p>a)The compressor continues to run for 30 or more seconds.</p> <p>b)The liquid pipe temperature or the condenser/evaporator temperature is 167°F [75°C] or more.</p> <p><u>These detected errors will not be cancelled until the power source is reset.</u></p>	<p>① Abnormal operation of 4-way valve</p> <p>② Disconnection of or leakage in refrigerant pipes</p> <p>③ Air into refrigerant piping</p> <p>④ Abnormal operation (no rotation) of indoor fan</p> <ul style="list-style-type: none"> · Defective fan motor. · Defective indoor control board. <p>⑤ Defective refrigerant circuit (clogging)</p>	<p>① <u>When this error occurs, be sure to replace the 4-way valve.</u></p> <p>② Check refrigerant pipes for disconnection or leakage.</p> <p>③ After the recovery of refrigerant, vacuum dry the whole refrigerant circuit.</p> <p>④ Refer to section "10-5. HOW TO CHECK THE PARTS".</p> <p>⑤ Check refrigerant circuit for operation.</p> <p><u>To avoid entry of moisture or air into refrigerant circuit which could cause abnormal high pressure, purge air in refrigerant circuit or replace refrigerant.</u></p>

<M-NET communication error>

Note: "Indoor unit" in the text indicates M-NET board in outdoor unit.

Check Code	Abnormal point and detection method	Cause	Judgment and action
A0 (6600)	<p>Address duplicate definition This error is displayed when transmission from the units of same address is detected. Note: The address and attribute displayed at remote controller indicate the controller that detected abnormality.</p>	<p>① There are 2 or more same address of controller of outdoor unit, indoor unit, FRESH MASTER, or LOSSNAY. ② Noise has entered into transmission signal and signal was transformed.</p>	<p>Search the unit with same address as abnormality occurred. If the same address is found, turn off the power supply of outdoor unit and indoor unit and FRESH MASTER or LOSSNAY at the same time for 2 minutes or more after the address is corrected, and turn the power on again. Check transmission waveform or noise on transmission wire.</p>
A2 (6602)	<p>Hardware error of transmission processor Transmission processor intended to transmit "0", but "1" appeared on transmission wire. Note: The address and attribute display at remote controller indicate the controller that detected abnormality.</p>	<p>① Error is detected if waveform is transformed when wiring works of transmission wire of outdoor unit, indoor unit, FRESH MASTER or LOSSNAY are done, or polarity is changed with the power on and transmission data collide each other. ② Defective transmitting receiving circuit of transmission processor ③ Transmission data is changed by the noise on transmission.</p>	<p>① If the works of transmission wire is done with the power on, turn off the power supply of outdoor unit and indoor unit and FRESH MASTER or LOSSNAY at the same time for 2 minutes or more, and turn the power on again. ② Check transmission waveform or noise on transmission wire.</p>
A3 (6603)	<p>BUS BUSY 1. Overtime error by collision damage Abnormal if transmitting signal is not possible for 8-10 minutes continuously because of collision of transmission. 2. Data could not reach transmission wire for 8-10 minutes continuously because of noise, etc. Note: The address and attribute displayed at remote controller indicate the controller that detected abnormality.</p>	<p>① Transmission processor could not transmit signal because short cycle voltage of noise and the like have entered into transmission wire continuously. ② Transmission quantity has increased and transmission is not possible because there was wiring mistake of terminal block for transmission wire (TB3) and terminal block for central control (TB7) in outdoor unit. ③ Transmission are mixed with others and occupation rate on transmission wire rose because of defective repeater (a function to connector or disconnect transmission of control and central control system) of outdoor unit, then abnormality is detected.</p>	<p>① Check if transmission wire of indoor unit, FRESH MASTER, LOSSNAY, or remote controller is not connected to terminal block for central control (TB7) of outdoor unit. ② Check if transmission wire of indoor unit, FRESH MASTER or LOSSNAY is not connected to terminal block for transmission wire of outdoor unit. ③ Check if terminal block for transmission wire (TB3) and terminal block for central control (TB7) is not connected. ④ Check transmission waveform or noise on transmission wire.</p>
A6 (6606)	<p>Communication error with communication processor Defective communication between unit processor and transmission processor Note: The address and attribute display at remote controller indicate the controller that detected abnormality.</p>	<p>① Data of transmission processor or unit processor is not transmitted normally because of accidental trouble such as noise or thunder surge. ② Address forwarding from unit processor is not transmitted normally because of defective transmission processor hardware.</p>	<p>Turn off the power supply of outdoor unit and indoor unit and FRESH MASTER or LOSSNAY at the same time for 2 minutes or more, and turn the power on again. System returns to normal if abnormality was accidental malfunction. If the same abnormality occurs again, abnormality-detected controller may be defective.</p>

Check Code	Abnormal point and detection method	Cause	Judgment and action
A7 (6607)	<p>NO ACK signal</p> <p>1. Transmitting side controller detects abnormal if a message was transmitted but there is no reply (ACK) that a message was received. Transmitting side detects abnormality every 30 seconds, 6 times continuously.</p> <p>Note: The address and attribute displayed at remote controller is indicate the controller that did not reply (ACK).</p>	<p>Common factor that has no relation with abnormality source.</p> <p>① The unit of former address does not exist as address switch has changed while the unit was energized.</p> <p>② Voltage drop and weak signal which lead communication error are caused by over-range transmission wire.</p> <ul style="list-style-type: none"> • Maximum distance... 656 ft [200 m] • Remote controller line (39 ft [12m]) <p>③ Voltage drop and weak signal which lead communication error are caused by type-unmatched transmission wire.</p> <p>Type... With shield wire- CVVS, CPEVS With normal wire (no shield)- VCTF, VCTFK, CVV CVS, VVR, VVF, VCT Diameter...1.25mm² [AWG16] or more</p> <p>④ Voltage drop and weak signal which lead communication error are caused by over-numbered units.</p> <p>⑤ Accidental malfunction of abnormality-detected controller (noise, thunder surge)</p> <p>⑥ Defective of abnormality-detected controller</p>	<p>Always try the following when the error "A7" occurs.</p> <p>① Turn off the power supply of outdoor unit and indoor unit and FRESH MASTER or LOSSNAY at the same time for 2 minutes or more, and turn the power on again. If malfunction was accidental, the unit returns to normal.</p> <p>② Check address switch of abnormality-detected address.</p> <p>③ Check disconnection or looseness of abnormality-detected transmission wire (terminal block and connector)</p> <p>④ Check if tolerance range of transmission wire is not exceeded.</p> <p>⑤ Check if type of transmission wire is correct or not.</p> <p>If there were some troubles of ①–⑤ above, repair the defective, then turn off the power supply of outdoor unit and indoor unit and FRESH MASTER or LOSSNAY at the same time for 2 minutes or more, and turn the power on again.</p> <ul style="list-style-type: none"> • If there was no trouble with ①–⑤ above in single refrigerant system (one outdoor unit), controller of displayed address or attribute is defective. • If there was no trouble with ①–⑤ above in different refrigerant system (2 or more outdoor units), judge with ⑥. <p>⑥ If address of abnormality source is the address that should not exist, there is the unit that memorizes nonexistent address information. Delete unused address information with manual setting function of remote controller.</p> <p>Only the system FRESH MASTER or LOSSNAY are connected to, or the system that is equipped with group setting of different refrigerant system.</p>
	<p>2. If displayed address or attribute is outdoor unit, indoor unit detects abnormality when indoor unit transmitted to outdoor unit and there was no reply (ACK).</p>	<p>① Contact failure of transmission wire of outdoor unit or indoor unit</p> <p>② Disconnection of transmission connector (CN2M) of outdoor unit</p> <p>③ Defective transmitting receiving circuit of outdoor unit or indoor unit</p>	<p>If there was no trouble with ①–⑥ above, replace the controller board of displayed address or attribute.</p> <p>If the unit does not return to normal, multi-controller board of outdoor unit may be defective (repeater circuit).</p> <p>Replace multi-controller board one by one to check if the unit returns to normal.</p>
	<p>3. If displayed address or attribute is indoor unit, remote controller detects abnormality when remote controller transmitted to indoor unit and there was no reply (ACK).</p>	<p>① During group operation with indoor unit of multi-refrigerant system, if remote controller transmit to indoor unit while outdoor unit power supply of one refrigerant system is turned off or within 2 minutes of restart, abnormality is detected.</p> <p>② Contact failure of transmission wire of remote controller or indoor unit</p> <p>③ Disconnection of transmission connector (CN2M) of indoor unit</p> <p>④ Defective transmitting receiving circuit of indoor unit or remote controller</p>	<p>If there was no trouble with ①–⑥ above, replace the controller board of displayed address or attribute.</p> <p>If the unit does not return to normal, multi-controller board of outdoor unit may be defective (repeater circuit).</p> <p>Replace multi-controller board one by one to check if the unit returns to normal.</p>

Continued to the next page.

From the previous page.

Check Code	Abnormal point and detection method	Cause	Judgment and action
A7 (6607)	4. If displayed address or attribute is remote controller, Indoor unit detects abnormality when indoor unit transmitted to remote controller and there was no reply (ACK).	<ul style="list-style-type: none"> ① During group operation with indoor unit of multi- refrigerant system, if indoor unit transmit to remote controller while outdoor unit power supply of one refrigerant system is turned off or within 2 minutes of restart, abnormality is detected. ② Contact failure of transmission wire of remote controller or indoor unit ③ Disconnection of transmission connector (CN2M) of indoor unit ④ Defective transmitting receiving circuit of indoor unit or remote controller 	Same as mentioned in "A7" of the previous page.
	5. If displayed address or attribute is FRESH MASTER, indoor unit detects abnormality when indoor unit transmitted to FRESH MASTER and there was no reply (ACK).	<ul style="list-style-type: none"> ① During sequential operation of indoor unit and FRESH MASTER of other refrigerant system, if indoor unit transmits to FRESH MASTER while outdoor unit power supply of same refrigerant system with FRESH MASTER is turned off or within 2 minutes of restart, abnormality is detected. ② Contact failure of transmission wire of indoor unit or FRESH MASTER ③ Disconnection of transmission connector (CN2M) of indoor unit or FRESH MASTER ④ Defective transmitting receiving circuit of indoor unit or FRESH MASTER 	
	6. If displayed address or attribute is LOSSNAY, indoor unit detects abnormality when indoor unit transmitted to LOSSNAY and there was no reply (ACK).	<ul style="list-style-type: none"> ① If the power supply of LOSSNAY is off, indoor unit detects abnormality when it transmits to LOSSNAY. ② During sequential operation of indoor unit and LOSSNAY of other refrigerant system, if indoor unit transmits to LOSSNAY while outdoor unit power supply of same refrigerant system with LOSSNAY is turned off or within 2 minutes of restart, abnormality is detected. ③ Contact failure of transmission wire of indoor unit of LOSSNAY ④ Disconnection of transmission connector (CN2M) of indoor unit ⑤ Defective transmitting receiving circuit of indoor unit or LOSSNAY 	
	7. If displayed address or attribute is non-existent,	<ul style="list-style-type: none"> ① The unit of former address does not exist as address switch has changed while the unit was energized. ② Abnormality is detected when indoor unit transmitted because the address of FRESH MASTER and LOSSNAY are changed after sequential operation of FRESH MASTER and LOSSNAY by remote controller. 	

Check Code	Abnormal point and detection method	Cause	Judgment and action
A8 (6608)	<p>M-NET NO RESPONSE</p> <p>Abnormal if a message was transmitted and there were reply (ACK) that message was received, but response command does not return. Transmitting side detects abnormality every 30 seconds, 6 times continuously.</p> <p>Note: The address and attribute displayed at remote controller indicate the controller that did not reply (ACK).</p>	<p>① Transmitting condition is repeated fault because of noise and the like.</p> <p>② Voltage drop and weak signal which lead communication error are caused by over-range transmission wire.</p> <ul style="list-style-type: none"> • Maximum distance... 656 ft [200 m] • Remote controller line(39 ft [12m]) <p>③ Voltage drop and weak signal which lead communication error are caused by over-range transmission wire.</p> <p>Type...</p> <ul style="list-style-type: none"> With shield wire- CVVS, CPEVS With normal wire (no shield)- VCTF, VCTFK, CVV CVS, VVR, VVF, VCT <p>Diameter...1.25 mm² [AWG16] or more</p> <p>④ Accidental malfunction of abnormality-detected controller</p>	<p>① Check transmission waveform or noise on transmission wire.</p> <p>② Turn off the power supply of outdoor unit and indoor unit and FRESH MASTER or LOSSNAY at the same time for 2 minutes or more, and turn the power on again. If malfunction was accidental, the unit returns to normal. If the same abnormality occurs again controller of displayed address and attribute may be defective.</p>

10-4. TROUBLESHOOTING BY INFERIOR PHENOMENA

Phenomena	Factor	Countermeasure
1. Remote controller display does not work.	<p>① 12 VDC is not supplied to remote controller.</p> <p>② 12–15 VDC is supplied to remote controller, however, no display is indicated.</p> <ul style="list-style-type: none"> • "Please Wait" is not displayed. • "Please Wait" is displayed. 	<p>① Check LED2 on indoor controller board.</p> <p>(1) When LED2 is lit: check the remote controller wiring for breaking or contact failure.</p> <p>(2) When LED2 is blinking: check short circuit of remote controller wiring.</p> <p>(3) When LED2 is not lit: refer to No.3 below.</p> <p>② Check the following.</p> <ul style="list-style-type: none"> • Failure of remote controller if "Please Wait" is not displayed • Refer to No.2 below if "Please Wait" is displayed.
2. "Please Wait" display is remained on the remote controller.	<p>① At longest 2 minutes after the power supply "Please Wait" is displayed to start up.</p> <p>② Communication error between the remote controller and indoor unit</p> <p>③ Communication error between the indoor and outdoor unit</p> <p>④ Outdoor unit protection device connector is open.</p>	<p>① Normal operation</p> <p>② Self-diagnosis of remote controller</p> <p>③ "Please Wait" is displayed for 6 minutes at most in the case of indoor/outdoor unit communication error. Check LED3 on indoor controller board.</p> <p>(1)When LED3 is not blinking: check indoor/outdoor connecting wire for miswiring. (Converse wiring of S1 and S2, or break of S3 wiring.)</p> <p>(2)When LED3 is blinking: indoor/outdoor connecting wire is normal.</p> <p>④ Check LED display on outdoor controller circuit board. Refer to "10-9. FUNCTION OF SWITCHES, CONNECTORS AND JUMPERS". Check protection device connector (63L and 63H) for contact failure. Refer to "10-8. TEST POINT DIAGRAM".</p>
3. When pressing the remote controller operation switch the OPERATION display is appeared but it will be turned off soon.	<p>① After cancelling to select function from the remote controller, the remote controller operation switch will not be accepted for approx. 30 seconds.</p>	<p>① Normal operation</p>

Phenomena	Factor	Countermeasure
4. Even controlling by the IR wireless remote controller no beep is heard and the unit does not start operating. Operation display is indicated on the IR wireless remote controller.	① The pair number settings of the IR wireless remote controller and indoor controller board are mismatched.	① Check the pair number settings.
5. When operating by the IR wireless remote controller, beep sound is heard, however, unit does not start operating.	① No operation for 2 minutes at most after the power supply ON. ② Hand-held remote controller operation is prohibited. • Remote controlling adaptor is connected to CN32 on the indoor controller board. • Hand-held remote controller operation is prohibited by centralized controller etc. since it is connected to MELANS. ③ Refer to factor of No.2 on previous page.	① Normal operation ② Normal operation ③ Check phenomena of No.2.
6. Remote controller display works normally and the unit performs cooling operation, however, the capacity cannot be fully obtained. (The air does not cool well.)	① Refrigerant shortage ② Filter clogging ③ Heat exchanger clogging ④ Air duct short cycle	① If refrigerant leaks, discharge temperature rises and LEV opening increases. Inspect leakage by checking the temperature and opening. Check pipe connections for gas leakage. ② Open intake grille and check the filter. Clean the filter by removing dirt or dust on it. ③ If the filter is clogged, indoor pipe temperature rises and discharging pressure increases. Check if heat exchanger is clogged by inspecting discharging pressure. Clean the heat exchanger. ④ Remove the shield.
7. Remote controller display works normally and the unit performs heating operation, however, the capacity cannot be fully obtained.	① Linear expansion valve fault Opening cannot be adjusted well due to linear expansion valve fault. ② Refrigerant shortage ③ Lack of insulation for refrigerant piping ④ Filter clogging ⑤ Heat exchanger clogging ⑥ Air duct short cycle ⑦ Bypass circuit of outdoor unit fault	① Discharge temperature and indoor heat exchanger temperature does not rise. Inspect the failure by checking discharge pressure. Replace linear expansion valve. ② If refrigerant leaks, discharge temperature rises and LEV opening increases. Inspect leakage by checking the temperature and opening. Check pipe connections for gas leakage. ③ Check the insulation. ④ Open intake grill and check the filter. Clean the filter by removing dirt or dust on it. ⑤ If the filter is clogged, indoor pipe temperature rises and discharge pressure increases. Check if heat exchanger is clogged by inspecting discharge pressure. Clean the heat exchanger. ⑥ Remove the shield. ⑦ Check refrigerant system during operation.
8. ①For 3 minutes after temperature adjuster turns off, the compressor will not start operating even if temperature adjuster is turned on. ②For 3 minutes after temperature adjuster turns on, the compressor will not stop operating even if temperature adjuster is turned off. (Compressor stops operating immediately when turning off by the remote controller.)	①② Normal operation (For protection of compressor)	①② Normal operation

Symptoms: “Please Wait” is kept being displayed on the remote controller.





Diagnosis flow	Cause	Inspection method and troubleshooting
<pre> graph TD Start([Check the display time of "Please Wait" after turning on the main power.]) --> D1{How long is "Please Wait" kept being displayed on the remote controller?} D1 -- "6 minutes or more" --> C1[Check the LED display of the outdoor controller circuit board.] D1 -- "2 to 6 minutes" --> D2{Are any check codes displayed on the remote controller?} D1 -- "2 minutes or less" --> C2["Please Wait" will be displayed during the startup diagnosis after turning on the main power.] D2 -- NO --> C2 D2 -- YES --> C3["Miswiring of indoor/outdoor connecting wire Breaking of indoor/outdoor connecting wire (S3) Defective indoor controller board Defective outdoor controller circuit board"] C1 --> D3{Are any check codes displayed on the LED?} D3 -- NO --> C4["Defective indoor controller board Defective remote controller"] D3 -- YES --> C3 </pre>	<ul style="list-style-type: none"> • “Please Wait” will be displayed during the startup diagnosis after turning on the main power. • Miswiring of indoor/outdoor connecting wire • Breaking of indoor/outdoor connecting wire (S3) • Defective indoor controller board • Defective outdoor controller circuit board • Defective indoor controller board • Defective remote controller 	<ul style="list-style-type: none"> • Normal The startup diagnosis will be over in around 2 minutes. • Refer to “Self-diagnosis action table” in order to solve the trouble. • In the case of communication errors, the display of remote controller may not match the LED display of the outdoor unit.

Symptoms: Nothing is displayed on the remote controller ①

LED display of the indoor controller board
 LED1: ○
 LED2: ○
 LED3: ○



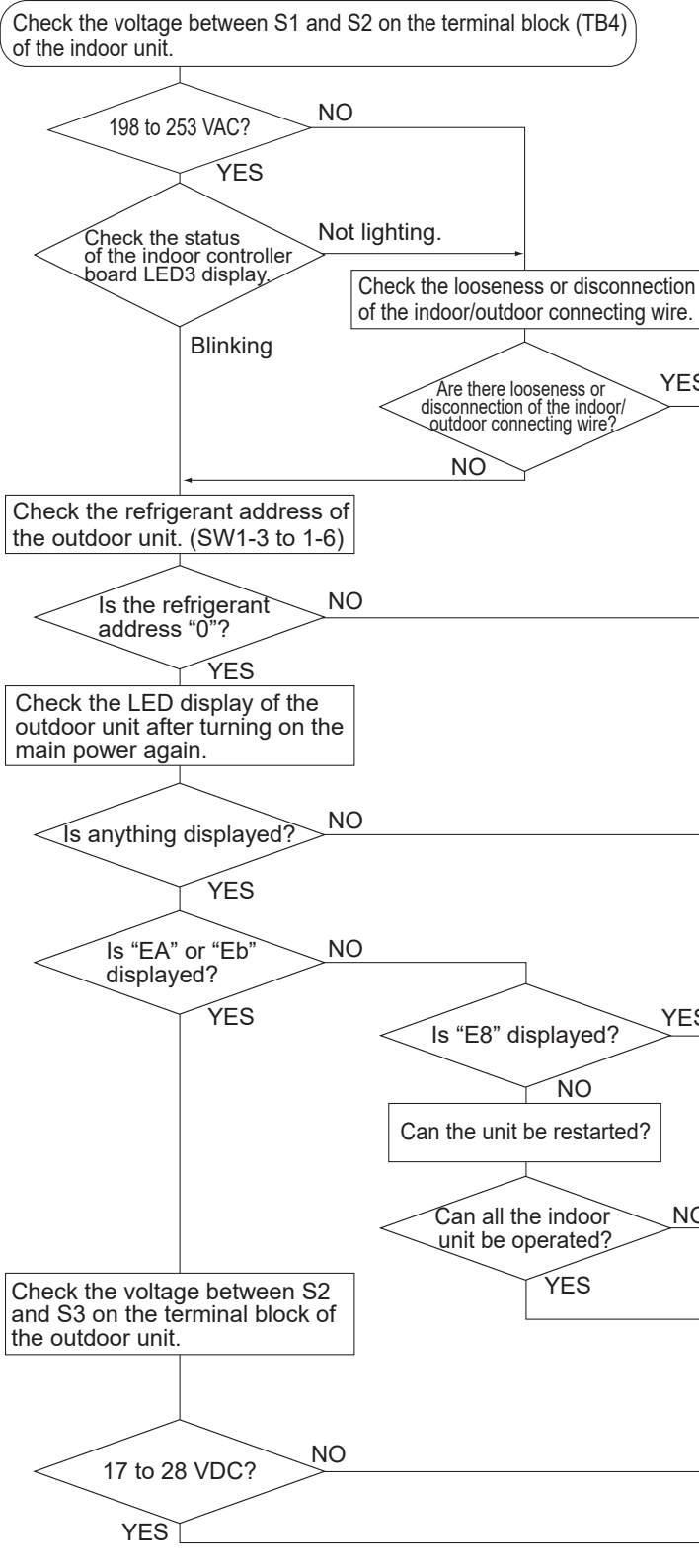

Diagnosis flow	Cause	Inspection method and troubleshooting
<pre> graph TD Start([Check the voltage between S1 and S2 on the terminal block (TB4) of the indoor unit.]) --> D1{198 to 253 VAC?} D1 -- NO --> C1[Check the voltage among L1 and L2 on the terminal block (TB1) of the outdoor power circuit board.] D1 -- YES --> D2{198 to 253 VAC?} C1 --> D2 D2 -- NO --> C2[• Troubles concerning power supply] D2 -- YES --> C3[Check the voltage between S1 and S2 on the terminal block (TB1) of the outdoor unit which is used to connect the indoor unit and the outdoor unit.] C3 --> D3{198 to 253 VAC?} D3 -- NO --> C4[• Bad wiring of the outdoor controller board • The fuses on the outdoor controller circuit board are blown.] D3 -- YES --> D4{12 to 16 VDC?} D4 -- YES --> C5[• Bad wiring of the outdoor controller board • The fuses on the outdoor controller circuit board are blown.] D4 -- NO --> C6[Check the voltage of indoor controller board (CN2D).] C6 --> D5{12 to 16 VDC?} D5 -- YES --> C7[• Defective indoor controller board] D5 -- NO --> C8[Check the voltage of the unit after removing the indoor power board (CN2S).] C8 --> D6{12 to 16 VDC?} D6 -- YES --> C9[• Miswiring, breaking or poor connection of indoor/outdoor connecting wire] D6 -- NO --> C10[• Defective indoor power board] </pre>	<ul style="list-style-type: none"> • Troubles concerning power supply • Bad wiring of the outdoor controller board • The fuses on the outdoor controller circuit board are blown. • Bad wiring of the outdoor controller board • The fuses on the outdoor controller circuit board are blown. • Defective indoor controller board • Miswiring, breaking or poor connection of indoor/outdoor connecting wire • Defective indoor power board 	<ul style="list-style-type: none"> • Check the power wiring to the outdoor unit. • Check the breaker. • Check the wiring of the outdoor unit. • Check if the wiring is bad. Check if the fuses are blown. The fuses on the outdoor controller circuit board will be blown when the indoor /outdoor connecting wire short-circuits. • Check if miswiring, breaking or poor contact is causing this problem. Indoor/outdoor connecting wire is polarized 3-core type. Connect the indoor unit and the outdoor unit by wiring each pair of S1, S2 and S3 on the both side of indoor/outdoor terminal blocks. • Replace the indoor controller board. • Check if there is miswiring or breaking of wire. • Replace the indoor power board.

Symptoms: Nothing is displayed on the remote controller ②

LED display of the indoor controller board
 LED1: 
 LED2: 
 LED3:  or 



Diagnosis flow	Cause	Inspection method and troubleshooting
 <pre> graph TD Start([Check the voltage between S1 and S2 on the terminal block TB4 of the indoor unit.]) --> D1{198 to 253 VAC?} D1 -- NO --> D2{Are there looseness or disconnection of the indoor/outdoor connecting wire?} D1 -- YES --> D3{Check the status of the indoor controller board LED3 display.} D3 -- Not lighting. --> D2 D3 -- Blinking --> D4[Check the refrigerant address of the outdoor unit. SW1-3 to 1-6] D4 --> D5{Is the refrigerant address "0"?} D5 -- NO --> C1[Normal Only the unit which has the refrigerant address "0" supplies power to the remote controller.] D5 -- YES --> D6[Check the LED display of the outdoor unit after turning on the main power again.] D6 --> D7{Is anything displayed?} D7 -- NO --> C2[Defective outdoor controller circuit board] D7 -- YES --> D8{Is "EA" or "Eb" displayed?} D8 -- NO --> D9{Is "E8" displayed?} D9 -- YES --> C3[Defective outdoor controller circuit board] D9 -- NO --> D10[Can the unit be restarted?] D10 --> D11{Can all the indoor unit be operated?} D11 -- NO --> C4[Defective indoor controller board] D11 -- YES --> D12[Check the voltage between S2 and S3 on the terminal block of the outdoor unit.] D12 --> D13{17 to 28 VDC?} D13 -- NO --> C5[Defective outdoor power circuit board] D13 -- YES --> C6[Defective indoor power board] </pre>	<ul style="list-style-type: none"> • Breaking or poor contact of the indoor/outdoor connecting wire • Normal Only the unit which has the refrigerant address "0" supplies power to the remote controller. • Defective outdoor controller circuit board • Defective outdoor controller circuit board • Defective indoor controller board • Influence of electromagnetic noise • Defective outdoor power circuit board • Defective indoor power board 	<ul style="list-style-type: none"> • Fix the breaking or poor contact of the indoor/outdoor connecting wire. • Set the refrigerant address to "0". In the case of the multiple grouping system, recheck the refrigerant address again. • Replace the outdoor controller circuit board. • Replace the outdoor controller circuit board. • Replace the indoor controller board of the indoor unit which does not operate. • Not abnormal. There may be the influence of electromagnetic noise. Check the transmission wire and get rid of the causes. • Replace the outdoor power circuit board. • Replace the indoor power board.

Symptoms: Nothing is displayed on the remote controller ③

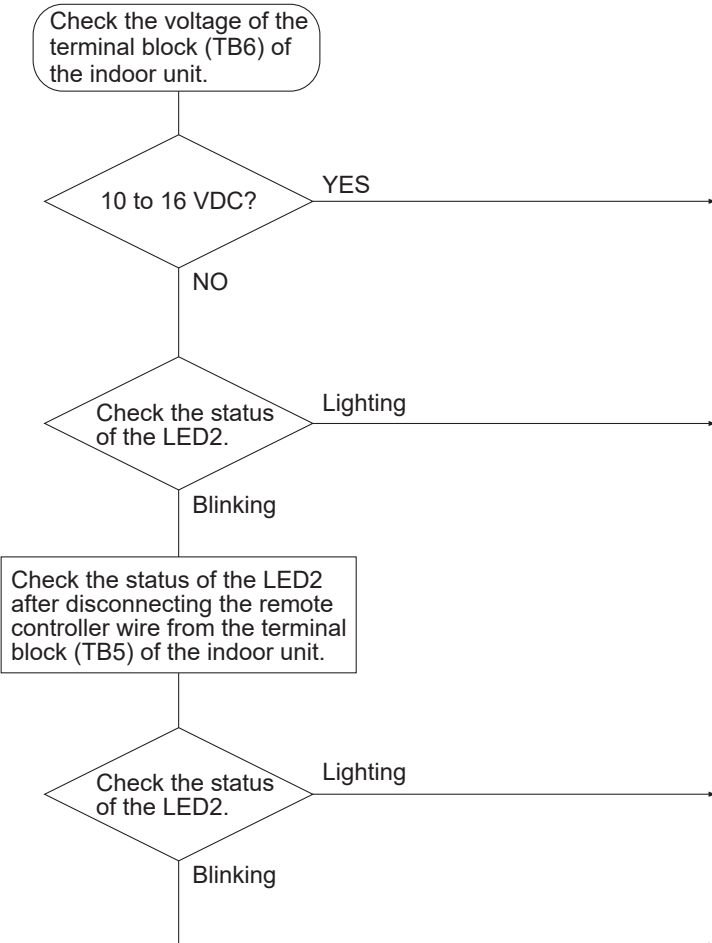
LED display of the indoor controller board
 LED1: 
 LED2:  or 
 LED3: 

Diagnosis flow	Cause	Inspection method and troubleshooting
 <pre> graph TD Start([Check the voltage of the terminal block (TB6) of the indoor unit.]) --> D1{10 to 16 VDC?} D1 -- YES --> C1[Defective remote controller] D1 -- NO --> D2{Check the status of the LED2.} D2 -- Lighting --> C2[Breaking or poor contact of the remote controller wire] D2 -- Blinking --> S2[Check the status of the LED2 after disconnecting the remote controller wire from the terminal block (TB5) of the indoor unit.] S2 --> D3{Check the status of the LED2.} D3 -- Lighting --> C3[The remote controller wire short-circuits] D3 -- Blinking --> C4[Defective indoor controller board] </pre>	<ul style="list-style-type: none"> • Defective remote controller • Breaking or poor contact of the remote controller wire • The remote controller wire short-circuits • Defective indoor controller board 	<ul style="list-style-type: none"> • Replace the remote controller. • Check if there is breaking or poor contact of the remote controller wire. Check the voltage of the terminal block (TB5) connecting the remote controller wire. If it is not between 10 VDC and 16 VDC, the indoor controller board must be defective. • Check if the remote controller wire is short-circuited. • Replace the indoor controller board.

• Before repair
Frequent calls from customers

Phone Calls From Customers		How to Respond	Note
Unit does not operate at all.	① The operating display of remote controller does not come on.	① Check if power is supplied to air conditioner. Nothing appears on the display unless power is supplied.	_____
	② Unit cannot be restarted for a while after it's stopped.	② Wait around 3 minutes to restart unit. The air conditioner is in a state of being protected by the microprocessor's directive. Once the compressor is stopped, the unit cannot be restarted for 3 minutes. This control is also applied when the unit is turned on and off by remote controller.	_____
	③ Check code appears and blinks on the display of remote controller.	③ Check code will be displayed if any protection devices of the air conditioner are actuated. What is check code? -----	Refer to "SELF-DIAGNOSIS ACTION TABLE". ▶Check if servicing is required for the error.
Remote controller	① "Please Wait" is displayed on the screen.	① Wait around 2 minutes. An automatic startup test will be conducted for 2 minutes when power is supplied to the air conditioner. "Please Wait" will be kept displayed while that time.	_____
	② "  " is displayed on the screen.	② This indicates that it is time to clean the air filters. Clean the air filters. "  " can be cleared from the filter information of the maintenance menu. See the operation manual that came with the product for how to clean the filters.	Display time of "  " depends on the model. Long life filter: 2500 h. Standard filter: 100 h.
	③ "Heat Standby" is displayed on the screen.	③ This is displayed when the unit starts HEAT operation, when the thermostat puts the compressor in operation mode, or when the outdoor unit ends DEFROST operation and returns to HEAT operation. The display will automatically disappear around 10 minutes later. While "Heat Standby" is displayed on the remote controller, the airflow amount will be restricted because the indoor unit's heat exchanger is not fully heated up. In addition to that, the up/down vane will be automatically set to horizontal blow in order to prevent cold air from directly blowing out to human body. The up/down vane will return to the setting specified by the remote controller when "Heat Standby" is released.	_____
	④ "Heat Defrost" is displayed on the screen. (No air comes out of the unit.)	④ The outdoor unit gets frosted when the outside temperature is low and the humidity is high. "Heat Defrost" indicates the DEFROST operation is being performed to melt this frost. The DEFROST operation ends in around 10 minutes (at most 15 minutes). During the DEFROST operation, the indoor unit's heat exchanger becomes cold, so the fan is stopped. The up/down vane will be automatically set to horizontal blow in order to prevent cold air from directly blowing out to human body. The display will turn into "Heat Standby" when DEFROST operation ends.	_____

Phone Calls From Customers	How to Respond	Note	
The room cannot be cooled or heated sufficiently.	① Check the set temperature of remote controller. The outdoor unit cannot be operated if the set temperature is not appropriate. The outdoor unit operates in the following modes. COOL: When the set temperature is lower than the room temperature. HEAT: When the set temperature is higher than the room temperature.	_____	
	② Check if filters are not dirty and clogged. If filters are clogged, the airflow amount will be reduced and the unit capacity will be lowered. See the instruction manual that came with the product for how to clean the filters.	_____	
	③ Check there is enough space around the air conditioner. If there are any obstacles in the air intake or air outlet of indoor/outdoor units, they block the airflow direction so that the unit capacity will be lowered.	_____	
Sound comes out from the air conditioner.	① An gas escaping sound is heard sometimes.	① This is not a malfunction. This is the sound when the flow of refrigerant in the air conditioner is switched.	_____
	② A cracking sound is heard sometimes.	② This is not a malfunction. This is the sound when internal parts of units expand or contract when the temperature changes.	_____
	③ A buzzing sound is heard sometimes.	③ This is not a malfunction. This is the sound when the outdoor unit starts operating.	_____
	④ A ticking sound is heard from the outdoor unit sometimes.	④ This is not a malfunction. This is the sound when the blower of the outdoor unit is controlling the airflow amount in order to keep the optimum operating condition.	_____
	⑤ A sound, similar to water flowing, is heard from the unit.	⑤ This is not a malfunction. This is the sound when the refrigerant is flowing inside the indoor unit.	_____
Something is wrong with the blower.....	① The fan speed does not match the setting of the remote controller during DRY operation.(No air comes out sometimes during DRY operation.)	① This is not a malfunction. During the DRY operation, the blower's ON/OFF is controlled by the microprocessor to prevent overcooling and to ensure efficient dehumidification. The fan speed cannot be set by the remote controller during DRY operation.	_____
	② The fan speed does not match the setting of the remote controller in HEAT operation.	② This is not a malfunction. 1) When the HEAT operation starts, to prevent the unit from blowing cold air, the fan speed is gradually increased from zero to the set speed, in proportion to the temperature rise of the discharged air. 2) When the room temperature reaches the set temperature and the outdoor unit stops, the unit starts the LOW AIR operation. 3) During the HEAT operation, the DEFROST operation is performed to defrost the outdoor unit. During the DEFROST operation, the blower is stopped to prevent cold air coming out of the indoor unit.	The up/down vane will be automatically set to horizontal blow in these cases listed up on the left (①–③). After a while, the up/down vane will be automatically moved according to the setting of the remote controller.

Phone Calls From Customers	How to Respond	Note	
Something is wrong with the blower.....	③ Air blows out for a while after HEAT operation is stopped.	③ This is not a malfunction. The blower is operating just for cooling down the heated-up air conditioner. This will be done within 1 minute. This control is conducted only when the HEAT operation is stopped with the electric heater ON.	However, this control is also applied to the models which has no electric heater.
Something is wrong with the airflow direction....	① The airflow direction is changed during COOL operation.	① If the up/down vane is set to downward in COOL operation, it will be automatically set to horizontal blow by the microprocessor in order to prevent water from dropping down. “1 h” will be displayed on the remote controller if the up/down vane is set to downward with the fan speed set to be less than “LOW”.	_____
	② The airflow direction is changed during HEAT operation. (The airflow direction cannot be set by remote controller.)	② In HEAT operation, the up/down vane is automatically controlled according to the temperature of the indoor unit's heat exchanger. In the following cases written below, the up/down vane will be set to horizontal blow, and the setting cannot be changed by remote controller. 1) At the beginning of the HEAT operation 2) While the outdoor unit is being stopped by thermostat or when the outdoor unit gets started to operate. 3) During DEFROST operation The airflow direction will be back to the setting of remote controller when the above situations are released.	“Heat Standby” will be displayed on the remote controller in the case of ① and ②. “Heat Defrost” will be displayed on the screen in the case of ③.
	③ The airflow direction does not change. (Up/down vane, left/right louver)	③ 1) Check if the vane is set to a fixed position. (Check if the vane motor connector is removed.) 2) Check if the air conditioner has a function for switching the air direction. 3) If the air conditioner does not have that function, “Unsupported function” will be displayed on the remote controller when “AIR DIRECTION” or “LOUVER” button is pressed.	_____
The air conditioner starts operating even though any buttons on the remote controller are not pressed.	① Check if you set ON/OFF timer. The air conditioner starts operating at the time designated if ON timer has been set before.	_____	
	② Check if any operations are ordered by distant control system or the central remote controller. While “Centrally controlled” is displayed on the remote controller, the air conditioner is under the control of external directive.	There might be a case that “Centrally controlled” will not be displayed.	
	③ Check if power is recovered from power failure (black out). The units will automatically start operating when power is recovered after power failure (black out) occurs. This function is called “auto recovery feature from power”.	_____	
The air conditioner stops even though any buttons on the remote controller are not pressed.	① Check if you set ON/OFF timer. The air conditioner stops operating at the time designated if OFF timer has been set before. ② Check if any operations are ordered by distant control system or the central remote controller. While “Centrally controlled” is displayed on the remote controller, the air conditioner is under the control of external directive.	There might be a case that “Centrally controlled” will not be displayed.	

Phone Calls From Customers	How to Respond	Note
A white mist is expelled from the indoor unit.	This is not a malfunction. This may occur when the operation is started in the room with high humidity.	_____
Water or moisture is expelled from the outdoor unit.	COOL: when pipes or piping joints are cooled, they sweat and water drips down. HEAT: water drips down from the heat exchanger. Note: Make use of optional parts "Drain Socket" and "Drain pan" if these water needs to be collected and drained out for once.	_____
The display of wireless remote controller gets dim or does not come on. The indoor unit does not receive a signal from remote controller at a long distance.	Batteries are being exhausted. Replace them and press the reset button of remote controller.	_____

10-5. HOW TO CHECK THE PARTS

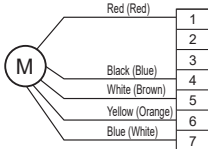
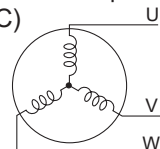
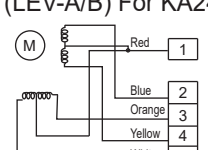
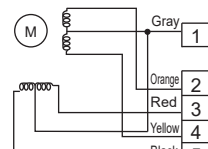
Parts name	Checkpoints														
Thermistor (TH3) <Liquid pipe> Thermistor (TH4) <Discharge> Thermistor (TH6) <2-phase pipe> Thermistor (TH7) <Ambient> Thermistor (TH8) <Heat sink> Thermistor (TH32) <Suction pipe> Thermistor (TH33) <Comp. surface>	Disconnect the connector then measure the resistance with a multimeter. (Ambient temperature 50 to 86°F [10 to 30°C]) <table border="1" style="margin-top: 10px;"> <thead> <tr> <th></th> <th>Normal</th> <th>Abnormal</th> </tr> </thead> <tbody> <tr> <td>TH4 TH33</td> <td>160 to 410 kΩ</td> <td rowspan="3">Open or short</td> </tr> <tr> <td>TH3 TH6 TH7 TH32</td> <td>4.3 to 9.6 kΩ</td> </tr> <tr> <td>TH8</td> <td>39 to 105 kΩ</td> </tr> </tbody> </table>		Normal	Abnormal	TH4 TH33	160 to 410 kΩ	Open or short	TH3 TH6 TH7 TH32	4.3 to 9.6 kΩ	TH8	39 to 105 kΩ				
	Normal	Abnormal													
TH4 TH33	160 to 410 kΩ	Open or short													
TH3 TH6 TH7 TH32	4.3 to 9.6 kΩ														
TH8	39 to 105 kΩ														
Fan motor(MF1, MF2) 	Measure the resistance between the connector pins with a tester. (At the ambient temperature 20°C) Note that the resistance between the connector pins may vary depending on the ambient temperature, so use those values as reference. <table border="1" style="margin-top: 10px;"> <thead> <tr> <th></th> <th colspan="4">Normal</th> <th>Abnormal</th> </tr> </thead> <tbody> <tr> <td>KA24/30/36</td> <td>Red - Blue 1.1 ± 0.6 MΩ</td> <td>Brown - Blue 40 ± 20 kΩ</td> <td>Orange - Blue 220 ± 110 kΩ</td> <td>White - Blue Open</td> <td>Open or short (short, for White - Blue)</td> </tr> </tbody> </table> *OL : Over Load		Normal				Abnormal	KA24/30/36	Red - Blue 1.1 ± 0.6 MΩ	Brown - Blue 40 ± 20 kΩ	Orange - Blue 220 ± 110 kΩ	White - Blue Open	Open or short (short, for White - Blue)		
	Normal				Abnormal										
KA24/30/36	Red - Blue 1.1 ± 0.6 MΩ	Brown - Blue 40 ± 20 kΩ	Orange - Blue 220 ± 110 kΩ	White - Blue Open	Open or short (short, for White - Blue)										
Solenoid valve coil <Four-way valve> (21S4)	Measure the resistance between the terminals with a multimeter. (Ambient temperature 68°F [20°C]) <table border="1" style="margin-top: 10px;"> <thead> <tr> <th>Model</th> <th>Normal</th> <th>Abnormal</th> </tr> </thead> <tbody> <tr> <td>KA24</td> <td>1190.3 ± 119 Ω</td> <td rowspan="2">Open or short</td> </tr> <tr> <td>KA30, 36</td> <td>1567.5 ± 156.8 Ω</td> </tr> </tbody> </table>	Model	Normal	Abnormal	KA24	1190.3 ± 119 Ω	Open or short	KA30, 36	1567.5 ± 156.8 Ω						
Model	Normal	Abnormal													
KA24	1190.3 ± 119 Ω	Open or short													
KA30, 36	1567.5 ± 156.8 Ω														
Motor for compressor (MC) 	Measure the resistance between the terminals with a multimeter. (Winding temperature 68°F [20°C]) <table border="1" style="margin-top: 10px;"> <thead> <tr> <th>Model</th> <th>Normal</th> <th>Abnormal</th> </tr> </thead> <tbody> <tr> <td>KA24</td> <td>0.74 Ω</td> <td rowspan="2">Open or short</td> </tr> <tr> <td>KA30, 36</td> <td>0.188 Ω</td> </tr> </tbody> </table>	Model	Normal	Abnormal	KA24	0.74 Ω	Open or short	KA30, 36	0.188 Ω						
Model	Normal	Abnormal													
KA24	0.74 Ω	Open or short													
KA30, 36	0.188 Ω														
Linear expansion valve (LEV-A/B) For KA24 	Disconnect the connector then measure the resistance with a tester. (Winding temperature 68°F [20°C]) <table border="1" style="margin-top: 10px;"> <thead> <tr> <th colspan="4">Normal</th> <th>Abnormal</th> </tr> </thead> <tbody> <tr> <td>Red - White</td> <td>Red - Orange</td> <td>Red - Yellow</td> <td>Red - Blue</td> <td rowspan="2">Open or short</td> </tr> <tr> <td colspan="4" style="text-align: center;">46 ± 4 Ω</td> </tr> </tbody> </table>	Normal				Abnormal	Red - White	Red - Orange	Red - Yellow	Red - Blue	Open or short	46 ± 4 Ω			
Normal				Abnormal											
Red - White	Red - Orange	Red - Yellow	Red - Blue	Open or short											
46 ± 4 Ω															
Linear expansion valve (LEV-A/B/C) For KA30/36 	Disconnect the connector then measure the resistance with a tester. (Winding temperature 68°F [20°C]) <table border="1" style="margin-top: 10px;"> <thead> <tr> <th colspan="4">Normal</th> <th>Abnormal</th> </tr> </thead> <tbody> <tr> <td>Gray - Black</td> <td>Gray - Red</td> <td>Gray - Yellow</td> <td>Gray - Orange</td> <td rowspan="2">Open or short</td> </tr> <tr> <td colspan="4" style="text-align: center;">46 ± 3 Ω</td> </tr> </tbody> </table>	Normal				Abnormal	Gray - Black	Gray - Red	Gray - Yellow	Gray - Orange	Open or short	46 ± 3 Ω			
Normal				Abnormal											
Gray - Black	Gray - Red	Gray - Yellow	Gray - Orange	Open or short											
46 ± 3 Ω															

Check method of DC fan motor (fan motor/outdoor controller circuit board)

① Notes

- High voltage is applied to the connector (CNF1, 2) for the fan motor. Pay attention to the service.
- Do not pull out the connector (CNF1, 2) for the motor with the power supply on.
(It causes trouble of the outdoor controller circuit board and fan motor.)

② Self check

Symptom: The outdoor fan cannot rotate.

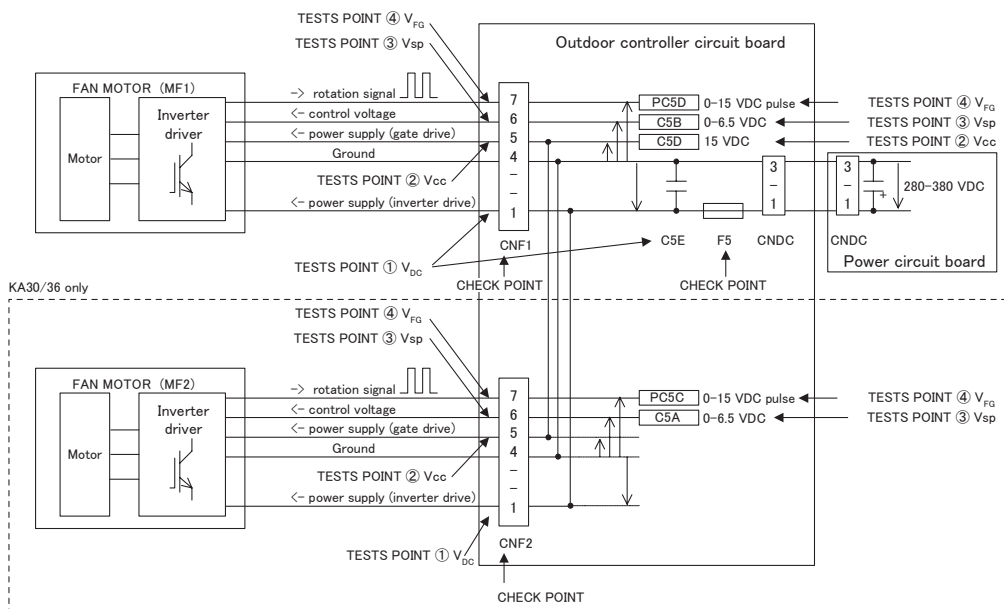
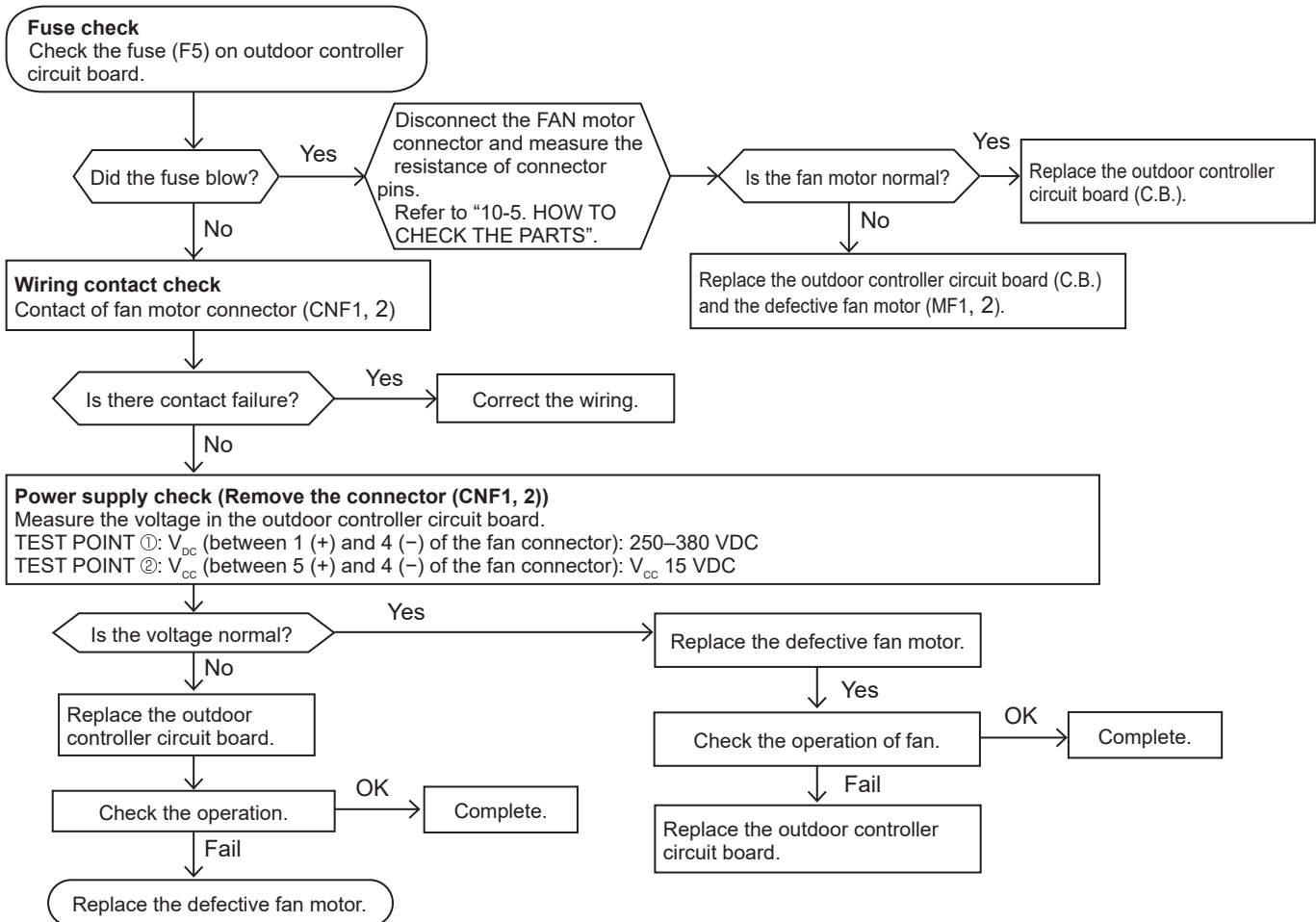

- The inverter control P.C. board is built in the fan motor of this outdoor unit.
- When F5 that is on controller board is opened, change the fan motor and outdoor controller board at the same time (F5 is impossible to change).
- It is abnormal when the abnormality is detected from either both fan motors or only one side.

10-6. HOW TO CHECK THE COMPONENTS

<Thermistor feature chart>

Low temperature thermistors

- Thermistor <Liquid pipe> (TH3)
- Thermistor <2-phase pipe> (TH6)
- Thermistor <Ambient> (TH7)
- Thermistor <Suction pipe> (TH32)

Thermistor R0 = 15 kΩ ± 3%

B constant = 3480 ± 1%

$$t (^{\circ}\text{C}): R_t = 15 \exp\left\{3480 \left(\frac{1}{273+t} - \frac{1}{273} \right)\right\}$$

$$T (^{\circ}\text{F}): R_T = 15 \exp\left\{3480 \left(\frac{1}{273+(T-32)/1.8} - \frac{1}{273} \right)\right\}$$

32°F [0°C]	15 kΩ	86°F [30°C]	4.3 kΩ
50°F [10°C]	9.6 kΩ	104°F [40°C]	3.0 kΩ
68°F [20°C]	6.3 kΩ		
77°F [25°C]	5.2 kΩ		

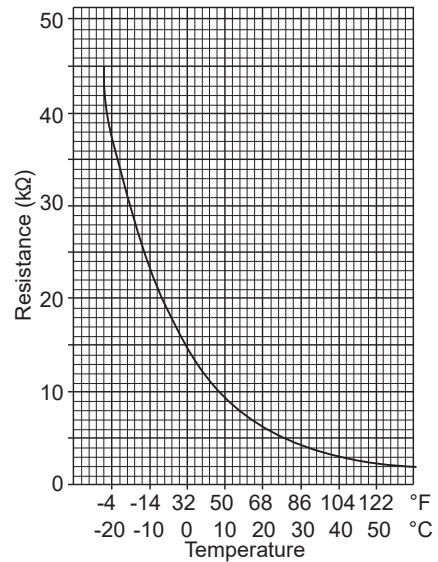

Medium temperature thermistor

- Thermistor <Heat sink> (TH8)

Thermistor R50 = 17 kΩ ± 2%

B constant = 4150 ± 3%

$$t (^{\circ}\text{C}): R_t = 17 \exp\left\{4150 \left(\frac{1}{273+t} - \frac{1}{323} \right)\right\}$$

$$T (^{\circ}\text{F}): R_T = 17 \exp\left\{4150 \left(\frac{1}{273+(T-32)/1.8} - \frac{1}{323} \right)\right\}$$

32°F [0°C]	180 kΩ
77°F [25°C]	50 kΩ
122°F [50°C]	17 kΩ
158°F [70°C]	8 kΩ
194°F [90°C]	4 kΩ

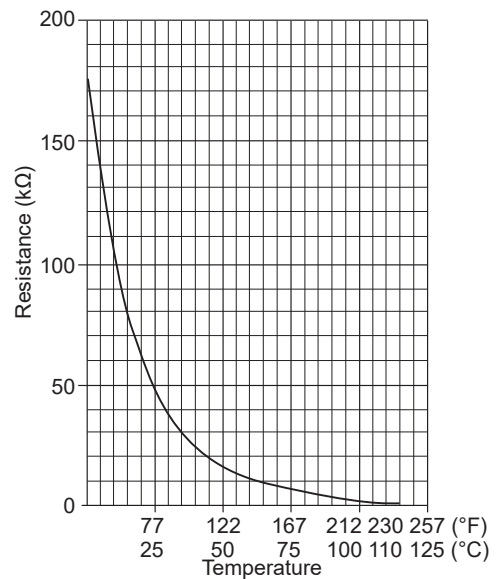

High temperature thermistors

- Thermistor <Discharge> (TH4)
- Thermistor <Comp. surface> (TH33)

Thermistor R120 = 7.465 kΩ ± 2%

B constant = 4057 ± 2%

$$t (^{\circ}\text{C}): R_t = 7.465 \exp\left\{4057 \left(\frac{1}{273+t} - \frac{1}{393} \right)\right\}$$

$$T (^{\circ}\text{F}): R_T = 7.465 \exp\left\{4057 \left(\frac{1}{273+(T-32)/1.8} - \frac{1}{393} \right)\right\}$$

68°F [20°C]	250 kΩ	158°F [70°C]	34kΩ
86°F [30°C]	160 kΩ	176°F [80°C]	24kΩ
104°F [40°C]	104 kΩ	194°F [90°C]	17.5kΩ
122°F [50°C]	70 kΩ	212°F [100°C]	13.0kΩ
140°F [60°C]	48 kΩ	230°F [110°C]	9.8kΩ

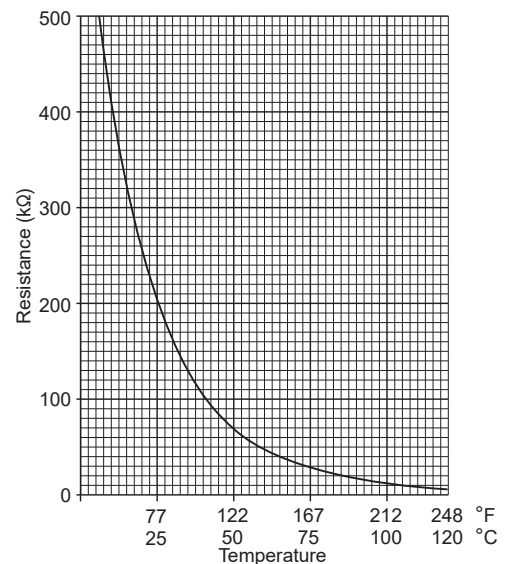

Linear expansion valve (KA24)

(1) Operation summary of the linear expansion valve

- Linear expansion valve opens/closes through stepping motor after receiving the pulse signal from the outdoor controller board.
- Valve position can be changed in proportion to the number of pulse signal.

<Connection between the outdoor controller board and the linear expansion valve>

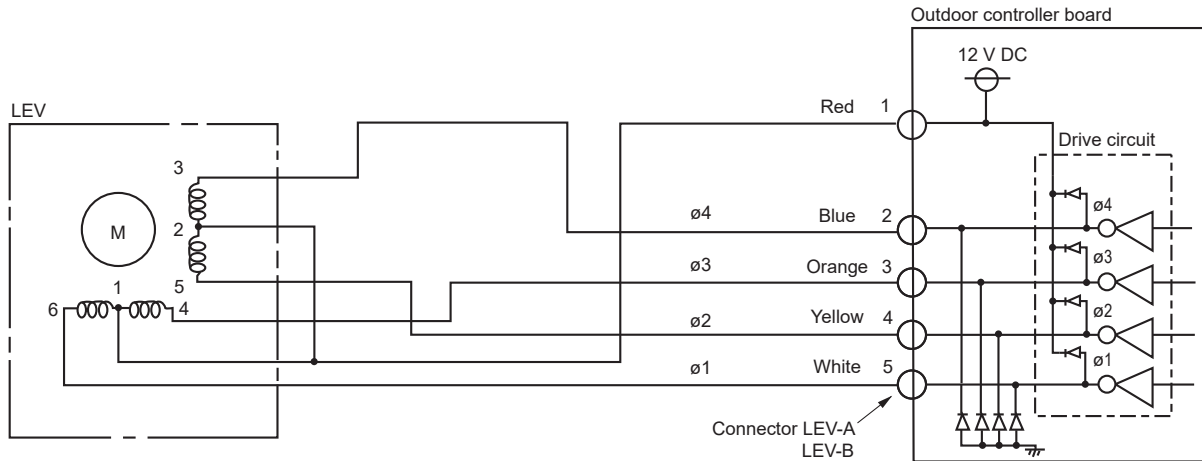

<Output pulse signal and the valve operation>

Output (Phase)	Output							
	1	2	3	4	5	6	7	8
ø1	ON	ON	OFF	OFF	OFF	OFF	OFF	ON
ø2	OFF	ON	ON	ON	OFF	OFF	OFF	OFF
ø3	OFF	OFF	OFF	ON	ON	ON	OFF	OFF
ø4	OFF	OFF	OFF	OFF	OFF	ON	ON	ON

The output pulse shifts in the following order.

Opening a valve: 8 → 7 → 6 → 5 → 4 → 3 → 2 → 1 → 8

Closing a valve: 1 → 2 → 3 → 4 → 5 → 6 → 7 → 8 → 1

- When linear expansion valve operation stops, all output phases become OFF.

(2) Linear expansion valve operation

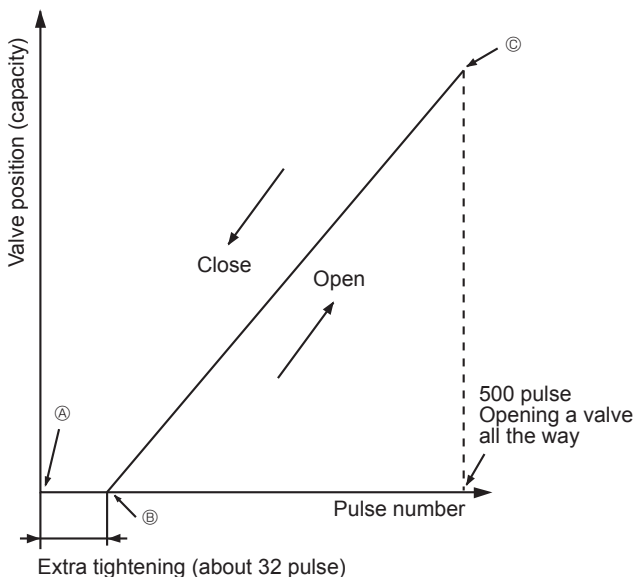

- When the power is turned on, 700 pulse closing valve signal will be sent till it goes to A point in order to define the valve position. (The pulse signal is being sent for about 20 seconds.)
- When the valve moves smoothly, there is no sound or vibration occurring from the linear expansion valve; however, when the pulse number moves from B to A or when the valve is locked, sound can be heard than normal situation. No sound is heard when the pulse number moves from B to A in case coil is burn out or motor is locked by open-phase.
- Sound can be detected by placing the ear against the screw driver handle while putting the screw driver to the linear expansion valve.

Linear expansion valve (KA30/36)

(1) Operation summary of the linear expansion valve

- Linear expansion valve opens/closes through stepping motor after receiving the pulse signal from the outdoor controller board.
- Valve position can be changed in proportion to the number of pulse signal.

<Connection between the outdoor controller board and the linear expansion valve>

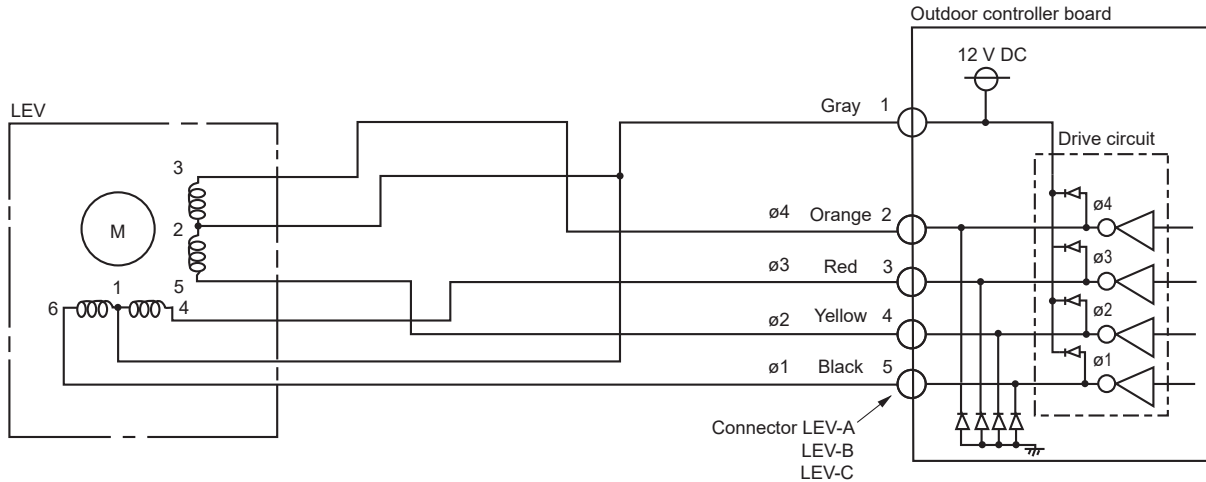

<Output pulse signal and the valve operation>

Output (Phase)	Output							
	1	2	3	4	5	6	7	8
ø1	ON	ON	OFF	OFF	OFF	OFF	OFF	ON
ø2	OFF	ON	ON	ON	OFF	OFF	OFF	OFF
ø3	OFF	OFF	OFF	ON	ON	ON	OFF	OFF
ø4	OFF	OFF	OFF	OFF	OFF	ON	ON	ON

The output pulse shifts in the following order.

Opening a valve: 8 → 7 → 6 → 5 → 4 → 3 → 2 → 1 → 8

Closing a valve: 1 → 2 → 3 → 4 → 5 → 6 → 7 → 8 → 1

- When linear expansion valve operation stops, all output phases become OFF.

(2) Linear expansion valve operation

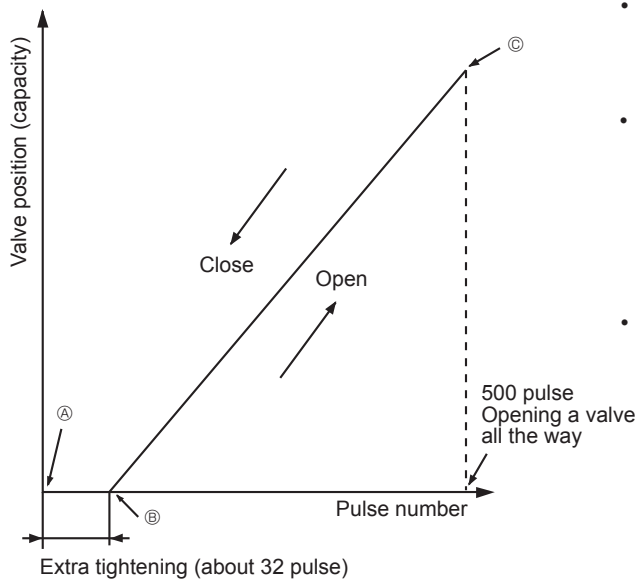

- When the power is turned on, 700 pulse closing valve signal will be sent till it goes to ④ point in order to define the valve position. (The pulse signal is being sent for about 20 seconds.)
- When the valve moves smoothly, there is no sound or vibration occurring from the linear expansion valve; however, when the pulse number moves from ③ to ④ or when the valve is locked, sound can be heard than normal situation. No sound is heard when the pulse number moves from ③ to ④ in case coil is burn out or motor is locked by open-phase.
- Sound can be detected by placing the ear against the screw driver handle while putting the screw driver to the linear expansion valve.

(3) How to attach and detach the coil of linear expansion valve

<Composition>

Linear expansion valve is separable into the main body and the coil as shown in the diagram below.

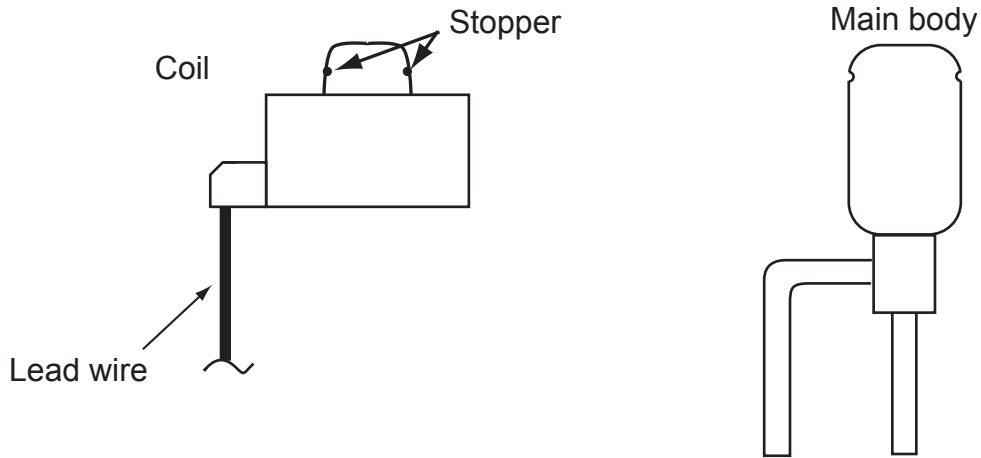

<How to detach the coil>

Hold the lower part of the main body (shown as A) firmly so that the main body does not move and detach the coil by pulling it upward.

Be sure to detach the coil holding main body firmly. Otherwise pipes can bend due to stress.

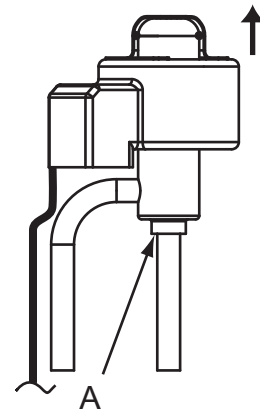

<How to attach the coil>

Hold the lower part of the main body (shown as A) firmly so that the main body does not move and attach the coil by inserting it downward into the main body. Then securely attach the coil stopper to main body. (At this time, be careful that stress is not added to lead wire and main body is not wound by lead wire.) If the stopper is not firmly attached to main body, coil may be detached from the main body and that can cause defective operation of linear expansion valve.

To prevent piping stress, be sure to attach the coil holding the main body of linear expansion valve firmly. Otherwise pipe may break.

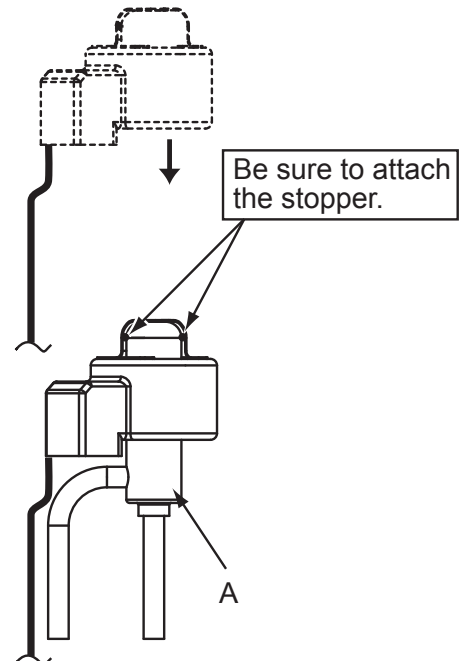

10-7. EMERGENCY OPERATION

(1) When any check codes shown below is displayed on outdoor unit, or microprocessor for wired remote controller or indoor unit has a failure while no other problems are found, emergency operation will be available by setting the emergency operation switch (SWE) ON and short-circuiting the connector (CN31) on outdoor controller board.

•When following abnormalities occur, emergency operation will be available.

Check code	Inspected content
U4	Open/short of thermistor (TH3/TH6/TH7/TH32/TH8)
UE	Open of pressure sensor (T _{63HS})
E8	Indoor/outdoor unit communication error •Signal receiving error (Outdoor unit)
E9	Indoor/outdoor unit communication error •Transmitting error (Indoor unit)
E0 – E7	Communication error other than outdoor unit
Ed	Communication error between outdoor controller board and M-NET board (Serial communication error)

(2) Check the following items and cautions for emergency operation

- ① Make sure that there is no abnormality in outdoor unit other than the above abnormalities. (Emergency operation will not be available when check codes other than the above are indicated.)
- ② For emergency operation, it is necessary to set the emergency operation switch (SWE) on indoor controller board. (Refer to the electrical wiring diagram of indoor unit for how to set the indoor unit.)
- ③ During emergency operation, the air-conditioner will continuously be operated by supplying power and stopping it. It can not be turned on or off by remote control, and temperature control is not possible.
- ④ Do not perform emergency heating operation for an extended period of time. If the outdoor unit starts defrosting during this period, cold air will blow out from the indoor unit.
- ⑤ Do not perform emergency cooling operation for more than 10 hours. Neglecting this could result in freezing the heat exchanger in indoor unit.

(3) Emergency operation procedure

- ① Turn the main power supply off.
- ② Turn on the emergency operation switch (SWE) on indoor controller board.
- ③ Set the shorting pins of emergency operation connector (CN31) on outdoor controller board to ON.
- ④ Use SW4-2 on outdoor controller board to set the operation mode (cooling or heating). (SW4-1 is not used.)
- ⑤ Turning the main power supply on will start the emergency operation.

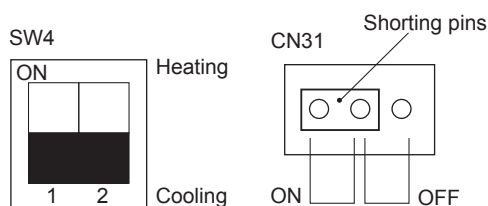

(4) Releasing emergency operation

- ① Turn the main power supply off.
- ② Set the emergency operation switch (SWE) on indoor controller board to OFF.
- ③ Set the shorting pins of emergency operation connector (CN31) on outdoor controller board to OFF.
- ④ Set SW4-2 on outdoor controller board as shown in the right.

Note: If shorting pins are not set on emergency operation connector (CN31), the setting remains OFF.

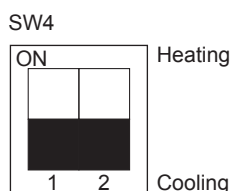

(5) Operation data during emergency operation

During emergency operation, no communication is performed with the indoor unit, so the data items needed for operation are set to the following values:

Operation data	Operation mode		Remarks
	COOL	HEAT	
Intake temperature (TH1)	81°F [27°C]	69°F [20.5°C]	
Indoor fluid pipe temperature (TH2)	41°F [5°C]	113°F [45°C]	
Indoor 2-phase pipe temperature (TH5)	41°F [5°C]	122°F [50°C]	
Set temperature	77°F [25°C]	72°F [22°C]	
Outdoor pipe temperature (TH3)	113°F [45°C]	41°F [5°C]	*1
Outdoor 2-phase pipe temperature (TH6)	122°F [50°C]	41°F [5°C]	*1
Outdoor air temperature (TH7)	95°F [35°C]	45°F [7°C]	*1
Temperature difference code (intake temperature - set temperature) (Tj)	5	5	*1
Discharge superheat (SHd)	54°F [30°C]	54°F [30°C]	
Sub-cool (SC)	9°F [5°C]	9°F [5°C]	*2

*1: If the thermistor temperature data is normal (not open/short), that data is loaded into the control as valid data. If the unit enters emergency operation because TH values have become mismatched, setting the thermistors to open/short corrects the settings.

*2: If one thermistor is set to open/short, the values for each will be different.
[Example] When pipe temperature thermistor (TH3) has an open or short circuit.

Thermistor	COOL	HEAT
TH3	113°F [45°C]	41°F [5°C]
TH6	Ta	Tb
	Regard normal figure as effective data.	
TH4	Tc	Td
	Regard normal figure as effective data.	
TH5	41°F [5°C]	122°F [50°C]
TH2	41°F [5°C]	113°F [45°C]
T _{63HS}	Te	Tf
	Regard normal figure as effective data.	

Discharge superheat (SHd)
Cooling = TH4 - T_{63HS} = Tc - Te
Heating = TH4 - T_{63HS} = Tf

Degree of subcooling (SC)
Cooling = T_{63HS} - TH3 = Te - 113°F [45°C]
Heating = T_{63HS} - TH2 = Tf - 113°F [45°C]

10-8. TEST POINT DIAGRAM

Outdoor controller circuit board

<CAUTION> TEST POINT① is high voltage.

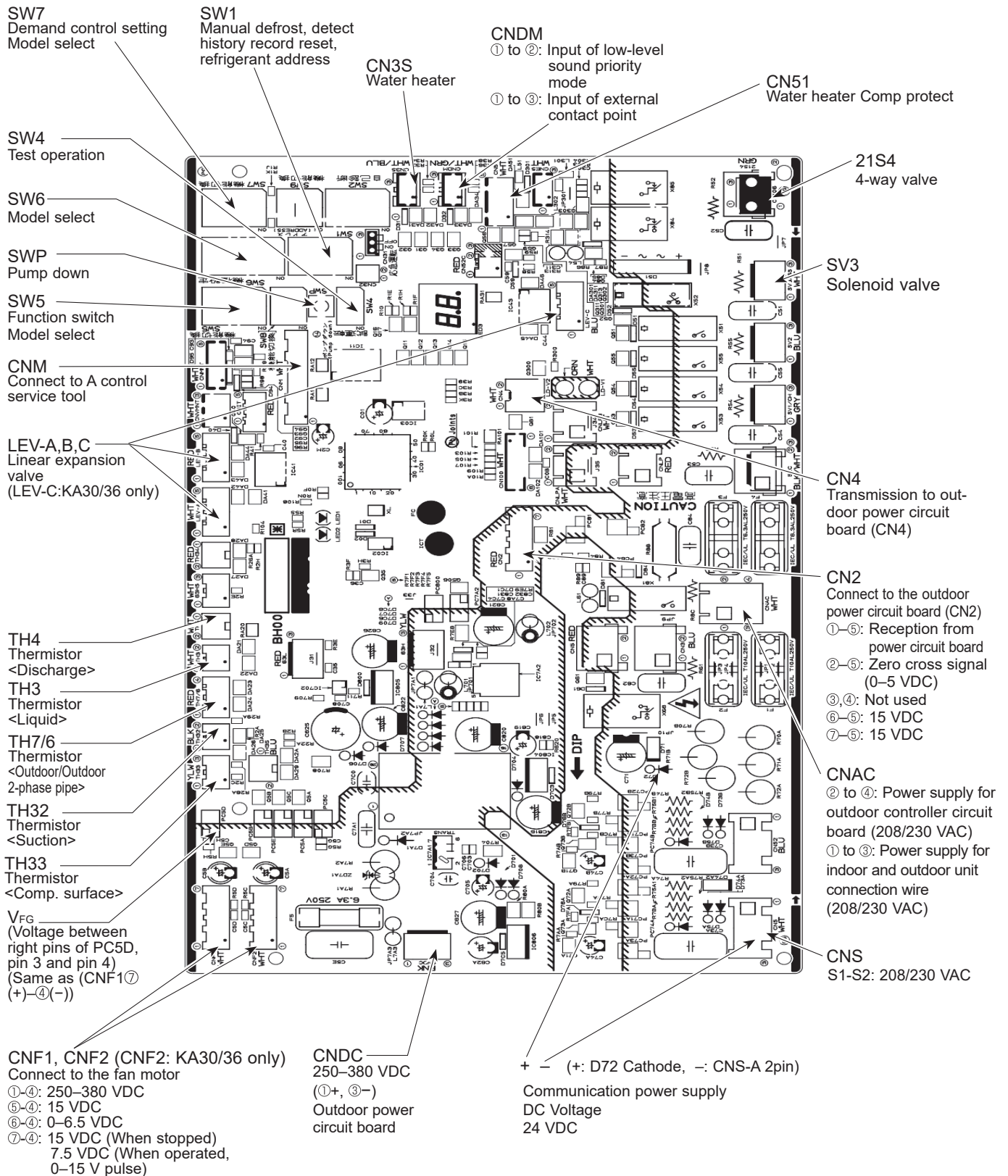

Outdoor power circuit board

SUZ-KA24NAHZ

Brief Check of POWER MODULE

If they are short-circuited, it means that they are broken.
Measure the resistance in the following points (connectors, etc.).

1. Check POWER MODULE

① Check of DIODE circuit

R - P1 S - P1 R - N1 S - N1

② Check of PFC circuit

P2 - L1 P2 - L3 N2 - L1 N2 - L3

③ Check of INVERTER circuit

P3 - U, P3 - V, P3 - W, N3 - U, N3 - V, N3 - W

Note: The marks R, S, L1, L3, P1, P2, P3, N1, N2, N3, U, V and W show in the diagram are not actually printed on the board.

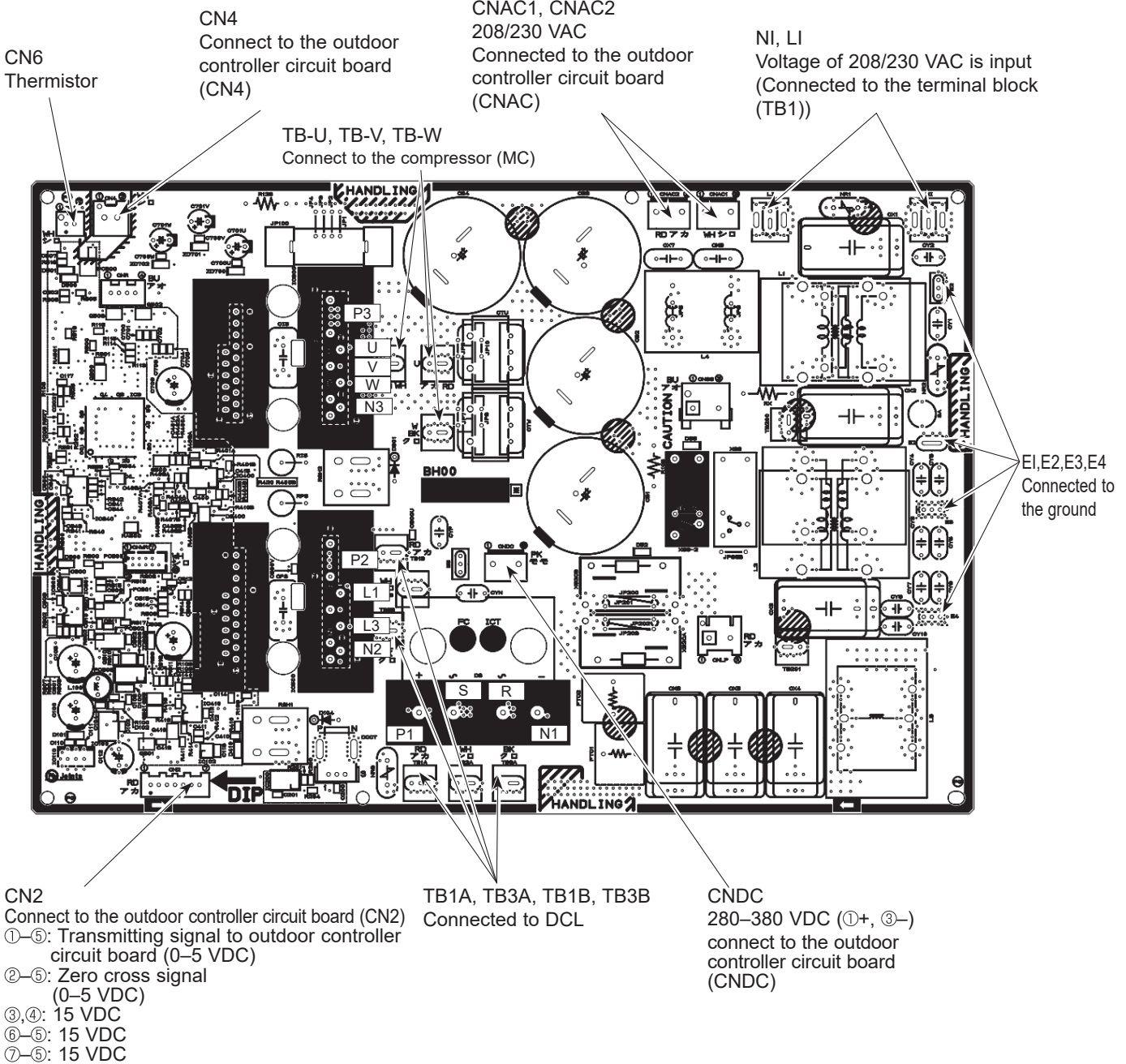

Outdoor power circuit board

SUZ-KA30NAHZ
SUZ-KA36NAHZ

Brief Check of POWER MODULE
 If they are short-circuited, it means that they are broken.
 Measure the resistance in the following points (connectors, etc.).

1. Check POWER MODULE

① Check of DIODE circuit
 R - P1 S - P1 R - N1 S - N1

② Check of PFC circuit
 P2 - L1 P2 - L2 P2 - L3 N2 - L1 N2 - L2 N2 - L3

③ Check of INVERTER circuit
 P3 - U , P3 - V , P3 - W , N3 - U , N3 - V , N3 - W

Note: The marks R , S , L1 , L2 , L3 , P1 , P2 , P3 , N1 , N2 , N3 , U , V and W show in the diagram are not actually printed on the board.

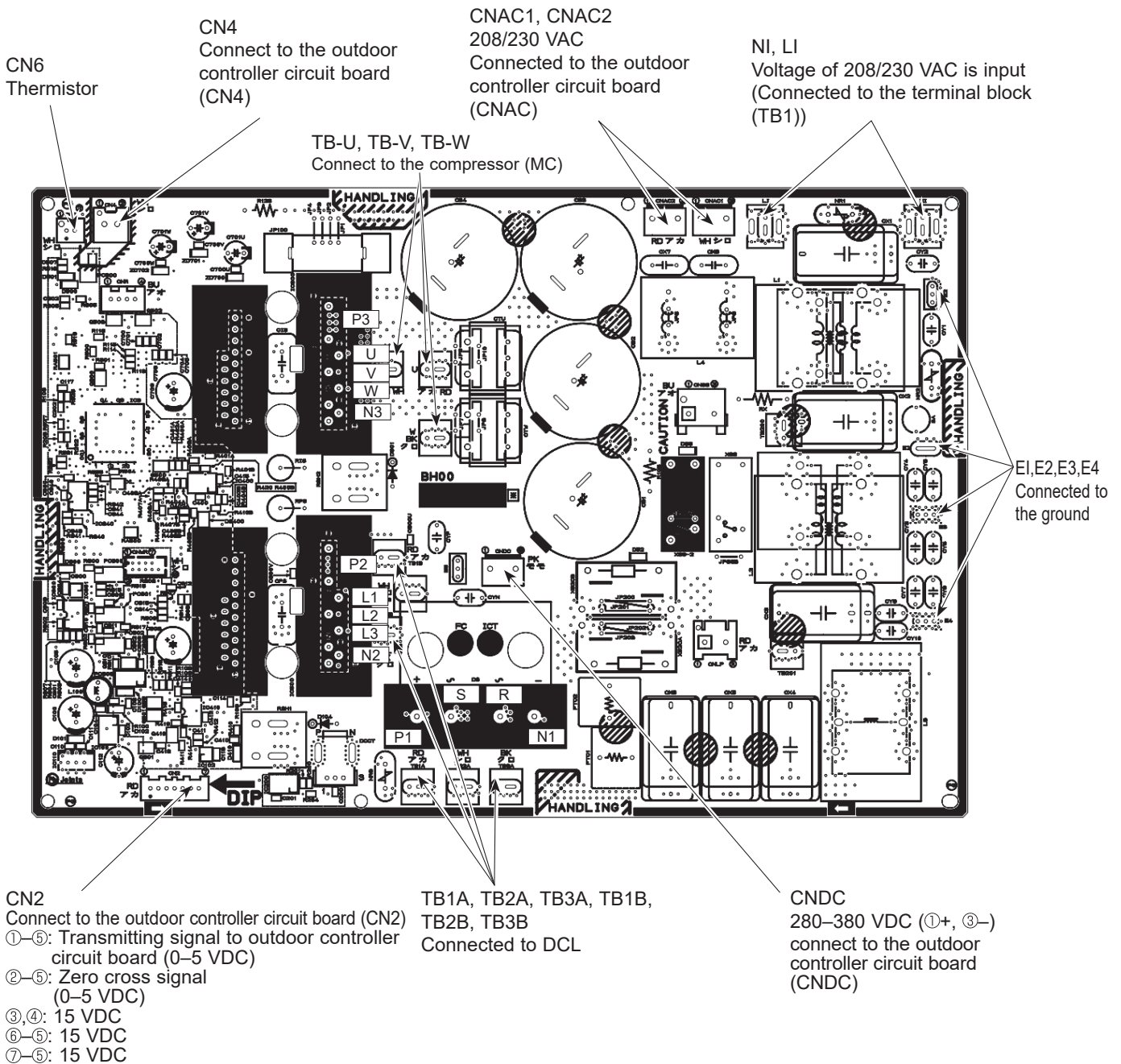

10-9. FUNCTION OF SWITCHES, CONNECTORS AND JUMPERS

(1) Function of switches

The black square (■) indicates a switch position.

Type of switch	Switch No.	Function	Action by the switch operation		Effective timing				
			ON	OFF					
DIP switch	SW1	1	Manual defrost*	Start	Normal	When compressor is working in heating operation.*			
		2	Abnormal history clear	Clear	Normal	off or operating			
		3	Refrigerant address setting	0					When power supply ON
				1					
				4					
				5					
				6					
				12					
		SW4	1	Test run	Operating	OFF	Under suspension		
			2	Test run mode setting	Heating	Cooling			
		SW8	1	Use of existing pipe	Used	Not used	Always		
			2	No function	—	—	—		
			3	Separate indoor/outdoor unit power supplies	Used	Not used	When power supply ON		
	Push switch	SWP	Pump down	Start	Normal	Under suspension			

*Manual defrost should be done as follows;

- ① Change the DIP SW1-1 on the outdoor controller board from OFF to ON.
- ② Manual defrost will start by the above operation 1 if all these conditions written below are satisfied.
 - Heat mode setting
 - 10 minutes have passed since compressor started operating or previous manual defrost finished.
 - Pipe temperature is less than or equal to 46°F [8°C].

Manual defrost will finish if certain conditions have been satisfied.

Manual defrost can be done if above conditions have been satisfied when DIP SW1-1 is changed from OFF to ON.

After DIP SW1-1 is changed from OFF to ON, there is no problem if DIP SW1-1 is left ON or changed to OFF again.

This depends on the service conditions.

Continue to the next page.

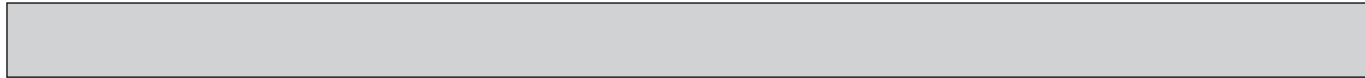

Type of Switch	Switch	No.	Function	Action by the switch operation		Effective timing																																																																			
				ON	OFF																																																																				
DIP switch	SW5	1	No function	—	—	—																																																																			
		2	Power failure automatic recovery*2	Auto recovery	No auto recovery	When power supply ON																																																																			
		3,4,5,6	No function	—	—	—																																																																			
	SW7*4	1	Model select*3	Demand function	Low noise mode	Always																																																																			
		2	No function	—	—	—																																																																			
		3	Max. Hertz setting (cooling)	Max. Hertz (cooling) × 0.8	Normal	Always																																																																			
		4	Max. Hertz setting (heating)	Max. Hertz (heating) × 0.8	Normal	Always																																																																			
		5	No function	—	—	—																																																																			
		6	Defrost setting	For high humidity	Normal	Always																																																																			
	SW9	1	No function	—	—	—																																																																			
		2	No function	—	—	—																																																																			
		3,4	No function	—	—	—																																																																			
	SW6	1	Model select	<table border="1"> <thead> <tr> <th>MODEL</th> <th colspan="8">SW6</th> </tr> </thead> <tbody> <tr> <td rowspan="2">24N</td> <td>ON</td> <td><input type="checkbox"/></td><td><input type="checkbox"/></td><td><input type="checkbox"/></td><td><input type="checkbox"/></td><td><input type="checkbox"/></td><td><input type="checkbox"/></td><td><input type="checkbox"/></td><td><input type="checkbox"/></td> </tr> <tr> <td>OFF</td> <td><input checked="" type="checkbox"/></td><td><input checked="" type="checkbox"/></td><td><input checked="" type="checkbox"/></td><td><input checked="" type="checkbox"/></td><td><input checked="" type="checkbox"/></td><td><input checked="" type="checkbox"/></td><td><input checked="" type="checkbox"/></td><td><input checked="" type="checkbox"/></td> </tr> <tr> <td rowspan="2">30N</td> <td>ON</td> <td><input type="checkbox"/></td><td><input type="checkbox"/></td><td><input type="checkbox"/></td><td><input type="checkbox"/></td><td><input type="checkbox"/></td><td><input type="checkbox"/></td><td><input type="checkbox"/></td><td><input type="checkbox"/></td> </tr> <tr> <td>OFF</td> <td><input checked="" type="checkbox"/></td><td><input checked="" type="checkbox"/></td><td><input checked="" type="checkbox"/></td><td><input checked="" type="checkbox"/></td><td><input checked="" type="checkbox"/></td><td><input checked="" type="checkbox"/></td><td><input checked="" type="checkbox"/></td><td><input checked="" type="checkbox"/></td> </tr> <tr> <td rowspan="2">36N</td> <td>ON</td> <td><input type="checkbox"/></td><td><input type="checkbox"/></td><td><input type="checkbox"/></td><td><input type="checkbox"/></td><td><input type="checkbox"/></td><td><input type="checkbox"/></td><td><input type="checkbox"/></td><td><input type="checkbox"/></td> </tr> <tr> <td>OFF</td> <td><input checked="" type="checkbox"/></td><td><input checked="" type="checkbox"/></td><td><input checked="" type="checkbox"/></td><td><input checked="" type="checkbox"/></td><td><input checked="" type="checkbox"/></td><td><input checked="" type="checkbox"/></td><td><input checked="" type="checkbox"/></td><td><input checked="" type="checkbox"/></td> </tr> </tbody> </table>				MODEL	SW6								24N	ON	<input type="checkbox"/>	<input type="checkbox"/>	<input type="checkbox"/>	<input type="checkbox"/>	<input type="checkbox"/>	<input type="checkbox"/>	<input type="checkbox"/>	<input type="checkbox"/>	OFF	<input checked="" type="checkbox"/>	<input checked="" type="checkbox"/>	<input checked="" type="checkbox"/>	<input checked="" type="checkbox"/>	<input checked="" type="checkbox"/>	<input checked="" type="checkbox"/>	<input checked="" type="checkbox"/>	<input checked="" type="checkbox"/>	30N	ON	<input type="checkbox"/>	<input type="checkbox"/>	<input type="checkbox"/>	<input type="checkbox"/>	<input type="checkbox"/>	<input type="checkbox"/>	<input type="checkbox"/>	<input type="checkbox"/>	OFF	<input checked="" type="checkbox"/>	<input checked="" type="checkbox"/>	<input checked="" type="checkbox"/>	<input checked="" type="checkbox"/>	<input checked="" type="checkbox"/>	<input checked="" type="checkbox"/>	<input checked="" type="checkbox"/>	<input checked="" type="checkbox"/>	36N	ON	<input type="checkbox"/>	<input type="checkbox"/>	<input type="checkbox"/>	<input type="checkbox"/>	<input type="checkbox"/>	<input type="checkbox"/>	<input type="checkbox"/>	<input type="checkbox"/>	OFF	<input checked="" type="checkbox"/>	<input checked="" type="checkbox"/>	<input checked="" type="checkbox"/>	<input checked="" type="checkbox"/>	<input checked="" type="checkbox"/>	<input checked="" type="checkbox"/>	<input checked="" type="checkbox"/>	<input checked="" type="checkbox"/>
		MODEL						SW6																																																																	
		24N						ON	<input type="checkbox"/>	<input type="checkbox"/>	<input type="checkbox"/>	<input type="checkbox"/>	<input type="checkbox"/>	<input type="checkbox"/>	<input type="checkbox"/>	<input type="checkbox"/>																																																									
								OFF	<input checked="" type="checkbox"/>	<input checked="" type="checkbox"/>	<input checked="" type="checkbox"/>	<input checked="" type="checkbox"/>	<input checked="" type="checkbox"/>	<input checked="" type="checkbox"/>	<input checked="" type="checkbox"/>	<input checked="" type="checkbox"/>																																																									
		30N						ON	<input type="checkbox"/>	<input type="checkbox"/>	<input type="checkbox"/>	<input type="checkbox"/>	<input type="checkbox"/>	<input type="checkbox"/>	<input type="checkbox"/>	<input type="checkbox"/>																																																									
								OFF	<input checked="" type="checkbox"/>	<input checked="" type="checkbox"/>	<input checked="" type="checkbox"/>	<input checked="" type="checkbox"/>	<input checked="" type="checkbox"/>	<input checked="" type="checkbox"/>	<input checked="" type="checkbox"/>	<input checked="" type="checkbox"/>																																																									
		36N						ON	<input type="checkbox"/>	<input type="checkbox"/>	<input type="checkbox"/>	<input type="checkbox"/>	<input type="checkbox"/>	<input type="checkbox"/>	<input type="checkbox"/>	<input type="checkbox"/>																																																									
								OFF	<input checked="" type="checkbox"/>	<input checked="" type="checkbox"/>	<input checked="" type="checkbox"/>	<input checked="" type="checkbox"/>	<input checked="" type="checkbox"/>	<input checked="" type="checkbox"/>	<input checked="" type="checkbox"/>	<input checked="" type="checkbox"/>																																																									
2																																																																									
3																																																																									
4																																																																									
5																																																																									
6																																																																									
7																																																																									
8																																																																									
SW5	6																																																																								

- *2 “Power failure automatic recovery” can be set by either remote controller or this DIP SW. If one of them is set to ON, “Auto recovery” activates. Please set “Auto recovery” basically by remote controller because all units do not have DIP SW. Please refer to the indoor unit installation manual.
- *3 SW7-1,2 are used for demand control. SW7-1,2 are effective only at the demand control. (Refer to next page: Special function (b))
- *4 Please do not use SW7-3-6 usually. Trouble might be caused by the usage condition.

(2) Function of connector

Types	Connector	Function	Action by open/ short operation		Effective timing
			Short	Open	
Connector	CN31	Emergency operation	Start	Normal	When power supply ON

Special function

(a) Low-level sound priority mode (Local wiring)

Unit enters into Low-level sound priority mode by external signal input setting.

Inputting external signals to the outdoor unit decreases the outdoor unit operation sound 3 to 4 dB lower than that of usual. Adding a commercial timer or on-off switch contactor setting to the CNDM connector which is optional contactor for demand input located on the outdoor controller board enables to control compressor operation frequency.

Note: The performance depends on the load of conditioned outdoor temperature.

How to wire

<Low-level sound priority mode circuit>

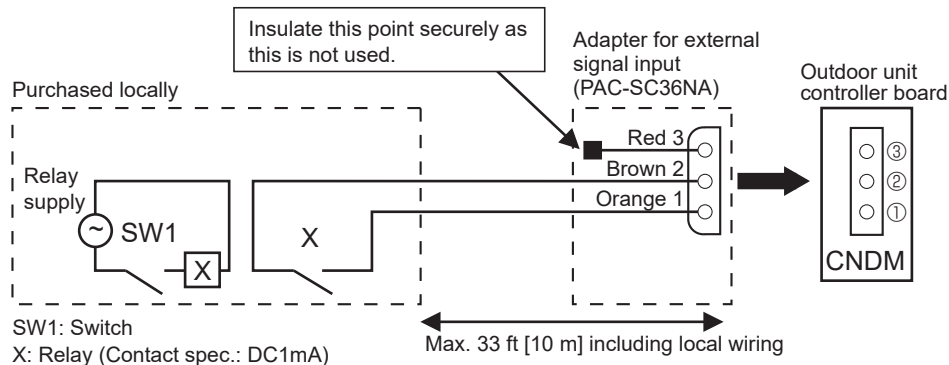

SW1: Switch

X: Relay (Contact spec.: DC1mA)

- 1) Make the circuit as shown above with adapter for external signal input (PAC-SC36NA).
- 2) Turn SW1 to on for Low-level sound priority mode.
Turn SW1 to off to release Low-level sound priority mode and normal operation.

(b) On demand control (Local wiring)

By performing the following modification, energy consumption can be reduced to 0–100% of the normal consumption.

The demand function will be activated when a commercially available timer or the contact input of an ON/OFF switch is added to the CNDM connector (option) on the control board of the outdoor unit.

- ① Complete the circuit as shown when using the external input adapter (PAC-SC36NA-E). (Option)
- ② By setting SW7-1 on the control board of the outdoor unit, the energy consumption (compared to the normal consumption) can be limited as shown below.

	SW7-1	SW2	SW3	Energy consumption
Demand function	ON	OFF	OFF	100%
		ON	OFF	75%
		ON	ON	50%
		OFF	ON	0% (Stop)

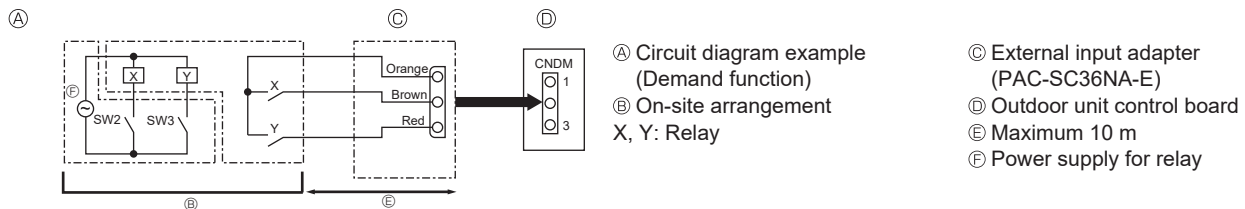

- Ⓐ Circuit diagram example (Demand function)
 Ⓑ On-site arrangement
 X, Y: Relay

- Ⓒ External input adapter (PAC-SC36NA-E)
 Ⓓ Outdoor unit control board
 Ⓔ Maximum 10 m
 Ⓕ Power supply for relay

<Display function of inspection for outdoor unit>

The blinking patterns of both LED1(green) and LED2(red) indicate the types of abnormality when it occurs. Types of abnormality can be indicated in details by connecting an optional part "A-Control Service Tool (PAC-SK52ST)" to connector CNM on outdoor controller board.

[Display]

(1)Normal condition

Unit condition	Outdoor controller board		A-Control Service Tool	
	LED1 (Green)	LED2 (Red)	Check code	Indication of the display
When the power is turned on	Lit	Lit	— ↔ —	Alternately blinking display
When unit stops	Lit	Not lit	00, etc.	Operation mode
When compressor is warming up	Lit	Not lit	08, etc.	
When unit operates	Lit	Lit	C5, H7, etc.	

(2)Abnormal condition

Indication		Contents	Check code*	Error Inspection method	Detailed reference page
Outdoor controller board					
LED1 (Green)	LED2 (Red)				
1 blinking	2 blinking	Connector(63H) is open.	F5	① Check if connector (63H) on the outdoor controller board is not disconnected. ② Check continuity of pressure switch (63H) by tester.	P.27
2 blinking	1 blinking	Miswiring of indoor/outdoor unit connecting wire, excessive number of indoor units (4 units or more)	—	① Check if indoor/outdoor connecting wire is connected correctly. ② Check if 4 or more indoor units are connected to outdoor unit. ③ Check if noise entered into indoor/outdoor connecting wire or power supply. ④ Re-check error by turning off power, and on again.	P.27 (EA)
		Miswiring of indoor/outdoor unit connecting wire (converse wiring or disconnection)	—		P.27 (Eb)
		Startup time over	—		P.27 (EC)
2 blinking	2 blinking	Indoor/outdoor unit communication error (signal receiving error) is detected by indoor unit.	E6	① Check if indoor/outdoor connecting wire is connected correctly. ② Check if noise entered into indoor/outdoor connecting wire or power supply. ③ Check if noise entered into indoor/outdoor controller board. ④ Re-check error by turning off power, and on again.	**
		Indoor/outdoor unit communication error (transmitting error) is detected by indoor unit.	E7		**
		Indoor/outdoor unit communication error (signal receiving error) is detected by outdoor unit.	—		P.33 (E8)
		Indoor/outdoor unit communication error (transmitting error) is detected by outdoor unit.	—		P.33 (E9)
3 blinking		Remote controller signal receiving error is detected by remote controller.	E0	① Check if connecting wire of indoor unit or remote controller is connected correctly. ② Check if noise entered into transmission wire of remote controller. ③ Re-check error by turning off power, and on again.	P.32
		Remote controller transmitting error is detected by remote controller.	E3		P.33
		Remote controller signal receiving error is detected by indoor unit.	E4		P.32
		Remote controller transmitting error is detected by indoor unit.	E5		P.33
4 blinking		Check code is not defined.	EF	① Check if noise entered into transmission wire of remote controller. ② Check if noise entered into indoor/outdoor connecting wire. ③ Re-check error by turning off power, and on again.	P.34
5 blinking		Serial communication error <Communication between outdoor controller board and outdoor power board> <Communication between outdoor controller board and M-NET P.C. board>	Ed	① Check if connector (CN4) on outdoor controller board and outdoor power board is not disconnected. ② Check if there is poor connection of connector on outdoor controller board(CNMNT and CNVMNT). ③ Check M-NET communication signal.	P.34
		Communication error of M-NET system	A0-A8		

*Check code displayed on remote controller

**Refer to service manual for indoor unit.

Indication		Error			
Outdoor controller board		Contents	Check code*	Inspection method	Detailed reference page
LED1 (Green)	LED2 (Red)				
3 blinking	1 blinking	Abnormality of Discharge temperature (TH4) and Comp. surface temperature (TH33)	U2	① Check if stop valves are open. ② Check if connectors (TH4, TH33, LEV-A, and LEV-B) on outdoor controller board are not disconnected. ③ Check if unit is filled with specified amount of refrigerant. ④ Measure resistance values among terminals on indoor valve and outdoor linear expansion valve using a tester.	P.28
		Abnormality of superheat due to low discharge temperature	U7		P.30
	2 blinking	Abnormal high pressure (High pressure switch 63H worked.)	U1	① Check if indoor/outdoor units have a short cycle on their air ducts. ② Check if connector (63H) (63L) on outdoor controller board is not disconnected. ③ Check if heat exchanger and filter is not dirty. ④ Measure resistance values among terminals on linear expansion valve using a tester.	P.28
		Abnormal low pressure (Low pressure switch 63L worked.)	UL		P.32
	3 blinking	Abnormality of outdoor fan motor rotational speed	U8	① Check the outdoor fan motor. ② Check if connector (TH3) (T _{63HS}) on outdoor controller board is disconnected.	P.30
		Protection from overheat operation(TH3)(T _{63HS})	Ud		P.31
	4 blinking	Compressor overcurrent breaking (Startup locked)	UF	① Check if stop valves are open. ② Check looseness, disconnection, and converse connection of compressor wiring. ③ Measure resistance values among terminals on compressor using a tester. ④ Check if outdoor unit has a short cycle on its air duct.	P.31
			UP		P.32
		Abnormality of current sensor (P.B.)	UH		P.31
		Abnormality of power module	U6		P.29
	5 blinking	Open/short of discharge thermistors (TH4) (TH33)	U3	① Check if connectors (TH3,TH32,TH33,TH4, and TH7/6) on outdoor controller board and connector (CN6) on outdoor power board are not disconnected. ② Measure resistance value of outdoor thermistors.	P.29
		Open/short of outdoor thermistors (TH3, TH32, TH6, TH7 and TH8)	U4		P.29
	6 blinking	Abnormality of heatsink temperature	U5	① Check if indoor/outdoor units have a short cycle on their air ducts. ② Measure resistance value of outdoor thermistor (TH8).	P.29
	7 blinking	Abnormality of voltage	U9	① Check looseness, disconnection, and converse connection of compressor wiring. ② Measure resistance value among terminals on compressor using a tester. ③ Check if power supply voltage decreases.	P.30
4 blinking	1 blinking	Abnormality of room temperature thermistor (TH1)	P1	① Check if connectors (CN20, CN21, CN29 and CN44) on indoor controller board are not disconnected. ② Measure resistance value of indoor thermistors.	**
		Abnormality of pipe temperature thermistor /Liquid (TH2)	P2		**
		Abnormality of pipe temperature thermistor/Condenser-Evaporator	P9		**
	2 blinking	Abnormality of drain sensor (DS) Float switch connector open (FS)	P4	① Check if connector (CN31)(CN4F) on indoor controller board is not disconnected. ② Measure resistance value of indoor thermistors. ③ Measure resistance value among terminals on drain-up machine using a tester. ④ Check if drain-up machine works. ⑤ Check drain function.	**
		Indoor drain overflow protection	P5		**
	3 blinking	Freezing (cooling)/overheating (heating) protection	P6	① Check if indoor unit has a short cycle on its air duct. ② Check if heat exchanger and filter is not dirty. ③ Measure resistance value on indoor and outdoor fan motors. ④ Check if the inside of refrigerant piping is not clogged.	**
	4 blinking	Abnormality of pipe temperature	P8	① Check if indoor thermistors(TH2 and TH5) are not disconnected from holder. ② Check if stop valve is open. ③ Check converse connection of extension pipe. (on plural units connection) ④ Check if indoor/outdoor connecting wire is connected correctly.(on plural units connection)	**

*Check code displayed on remote controller

**Refer to service manual for indoor unit.

<Outdoor unit operation monitor function>



[When optional part "A-Control Service Tool(PAC-SK52ST)" is connected to outdoor controller board(CNM)]

Digital indicator LED1 displays 2 digit number or code to inform operation condition and the meaning of check code by controlling DIP SW2 on "A-Control Service Tool".

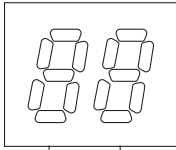
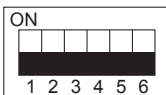
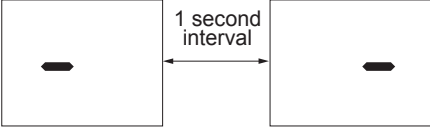
Operation indicator SW2: Indicator change of self-diagnosis

SW2 setting	Display detail	Explanation for display	Unit																																																																	
	<p><Digital indicator LED1 working details> (Be sure that 1 to 6 in the SW2 are set to OFF.)</p> <p>(1) Display when the power supply turns ON When the power supply turns ON, blinking displays by turns. Wait for 4 minutes at the longest.</p> <p>(2) When the display lights (Normal operation)</p> <p>①Operation mode display</p> <div style="display: flex; justify-content: space-around; align-items: center;"> <div style="text-align: center;">  <p>LED1 (Lighting)</p> </div> <div style="text-align: center;">  <p>SW2 (Initial setting)</p> </div> </div> <div style="display: flex; justify-content: space-around; margin-top: 10px;"> <div style="text-align: center;"> <p>The tens digit: Operation mode</p> <table border="1" style="border-collapse: collapse;"> <thead> <tr> <th>Display</th> <th>Operation Model</th> </tr> </thead> <tbody> <tr><td>O</td><td>OFF / FAN</td></tr> <tr><td>C</td><td>COOLING / DRY</td></tr> <tr><td>H</td><td>HEATING</td></tr> <tr><td>d</td><td>DEFROSTING</td></tr> </tbody> </table> </div> <div style="text-align: center;"> <p>The ones digit: Relay output</p> <table border="1" style="border-collapse: collapse;"> <thead> <tr> <th>Display</th> <th>Warming-up Compressor</th> <th>Compressor</th> <th>4-way valve</th> <th>Solenoid valve</th> </tr> </thead> <tbody> <tr><td>0</td><td>—</td><td>—</td><td>—</td><td>—</td></tr> <tr><td>1</td><td>—</td><td>—</td><td>—</td><td>ON</td></tr> <tr><td>2</td><td>—</td><td>—</td><td>ON</td><td>—</td></tr> <tr><td>3</td><td>—</td><td>—</td><td>ON</td><td>ON</td></tr> <tr><td>4</td><td>—</td><td>ON</td><td>—</td><td>—</td></tr> <tr><td>5</td><td>—</td><td>ON</td><td>—</td><td>ON</td></tr> <tr><td>6</td><td>—</td><td>ON</td><td>ON</td><td>—</td></tr> <tr><td>7</td><td>—</td><td>ON</td><td>ON</td><td>ON</td></tr> <tr><td>8</td><td>ON</td><td>—</td><td>—</td><td>—</td></tr> <tr><td>A</td><td>ON</td><td>—</td><td>ON</td><td>—</td></tr> </tbody> </table> </div> </div>	Display	Operation Model	O	OFF / FAN	C	COOLING / DRY	H	HEATING	d	DEFROSTING	Display	Warming-up Compressor	Compressor	4-way valve	Solenoid valve	0	—	—	—	—	1	—	—	—	ON	2	—	—	ON	—	3	—	—	ON	ON	4	—	ON	—	—	5	—	ON	—	ON	6	—	ON	ON	—	7	—	ON	ON	ON	8	ON	—	—	—	A	ON	—	ON	—		
Display	Operation Model																																																																			
O	OFF / FAN																																																																			
C	COOLING / DRY																																																																			
H	HEATING																																																																			
d	DEFROSTING																																																																			
Display	Warming-up Compressor	Compressor	4-way valve	Solenoid valve																																																																
0	—	—	—	—																																																																
1	—	—	—	ON																																																																
2	—	—	ON	—																																																																
3	—	—	ON	ON																																																																
4	—	ON	—	—																																																																
5	—	ON	—	ON																																																																
6	—	ON	ON	—																																																																
7	—	ON	ON	ON																																																																
8	ON	—	—	—																																																																
A	ON	—	ON	—																																																																
	<p>②Display during error postponement Postponement code is displayed when compressor stops due to the work of protection device. Postponement code is displayed while error is being postponed.</p> <p>(3) When the display blinks Inspection code is displayed when compressor stops due to the work of protection devices.</p> <div style="display: flex; justify-content: space-between;"> <table border="1" style="border-collapse: collapse; width: 15%;"> <thead> <tr> <th>Display</th> <th>Inspection unit</th> </tr> </thead> <tbody> <tr><td>0</td><td>Outdoor unit</td></tr> <tr><td>1</td><td>Indoor unit 1</td></tr> <tr><td>2</td><td>Indoor unit 2</td></tr> </tbody> </table> <table border="1" style="border-collapse: collapse; width: 65%;"> <thead> <tr> <th>Display</th> <th>Contents to be inspected (During operation)</th> </tr> </thead> <tbody> <tr><td>U1</td><td>Abnormal high pressure (63H worked)</td></tr> <tr><td>U2</td><td>Abnormal high discharge temperature, shortage of refrigerant</td></tr> <tr><td>U3</td><td>Open/short circuit of discharge thermistor (TH4) (TH33)</td></tr> <tr><td>U4</td><td>Open/short of outdoor unit thermistors (TH3, TH32, TH6, TH7 and TH8)</td></tr> <tr><td>U5</td><td>Abnormal temperature of heatsink</td></tr> <tr><td>U6</td><td>Abnormality of power module</td></tr> <tr><td>U7</td><td>Abnormality of superheat due to low discharge temperature</td></tr> <tr><td>U8</td><td>Abnormality in outdoor fan motor</td></tr> <tr><td>Ud</td><td>Overheat protection</td></tr> <tr><td>UE</td><td>Abnormal pressure of 63HS</td></tr> <tr><td>UF</td><td>Compressor overcurrent interruption (When Comp. locked)</td></tr> <tr><td>UH</td><td>Current sensor error</td></tr> <tr><td>UL</td><td>Abnormal low pressure(63L worked)</td></tr> <tr><td>UP</td><td>Compressor overcurrent interruption</td></tr> <tr><td>P1~P8</td><td>Abnormality of indoor units</td></tr> <tr><td>PL</td><td>Abnormal refrigerant circuit</td></tr> <tr><td>A0~A7</td><td>Communication error of M-NET system</td></tr> </tbody> </table> </div>	Display	Inspection unit	0	Outdoor unit	1	Indoor unit 1	2	Indoor unit 2	Display	Contents to be inspected (During operation)	U1	Abnormal high pressure (63H worked)	U2	Abnormal high discharge temperature, shortage of refrigerant	U3	Open/short circuit of discharge thermistor (TH4) (TH33)	U4	Open/short of outdoor unit thermistors (TH3, TH32, TH6, TH7 and TH8)	U5	Abnormal temperature of heatsink	U6	Abnormality of power module	U7	Abnormality of superheat due to low discharge temperature	U8	Abnormality in outdoor fan motor	Ud	Overheat protection	UE	Abnormal pressure of 63HS	UF	Compressor overcurrent interruption (When Comp. locked)	UH	Current sensor error	UL	Abnormal low pressure(63L worked)	UP	Compressor overcurrent interruption	P1~P8	Abnormality of indoor units	PL	Abnormal refrigerant circuit	A0~A7	Communication error of M-NET system																							
Display	Inspection unit																																																																			
0	Outdoor unit																																																																			
1	Indoor unit 1																																																																			
2	Indoor unit 2																																																																			
Display	Contents to be inspected (During operation)																																																																			
U1	Abnormal high pressure (63H worked)																																																																			
U2	Abnormal high discharge temperature, shortage of refrigerant																																																																			
U3	Open/short circuit of discharge thermistor (TH4) (TH33)																																																																			
U4	Open/short of outdoor unit thermistors (TH3, TH32, TH6, TH7 and TH8)																																																																			
U5	Abnormal temperature of heatsink																																																																			
U6	Abnormality of power module																																																																			
U7	Abnormality of superheat due to low discharge temperature																																																																			
U8	Abnormality in outdoor fan motor																																																																			
Ud	Overheat protection																																																																			
UE	Abnormal pressure of 63HS																																																																			
UF	Compressor overcurrent interruption (When Comp. locked)																																																																			
UH	Current sensor error																																																																			
UL	Abnormal low pressure(63L worked)																																																																			
UP	Compressor overcurrent interruption																																																																			
P1~P8	Abnormality of indoor units																																																																			
PL	Abnormal refrigerant circuit																																																																			
A0~A7	Communication error of M-NET system																																																																			
	<table border="1" style="border-collapse: collapse; width: 100%;"> <thead> <tr> <th>Display</th> <th>Contents to be inspected (When power is turned on)</th> </tr> </thead> <tbody> <tr><td>F3</td><td>63L connector(red) is open.</td></tr> <tr><td>F5</td><td>63H connector(yellow) is open.</td></tr> <tr><td>E8</td><td>Indoor/outdoor communication error (Signal receiving error) (Outdoor unit)</td></tr> <tr><td>E9</td><td>Indoor/outdoor communication error (Transmitting error) (Outdoor unit)</td></tr> <tr><td>EA</td><td>Miswiring of indoor/outdoor unit connecting wire, excessive number of indoor units (4 units or more)</td></tr> <tr><td>Eb</td><td>Miswiring of indoor/outdoor unit connecting wire(converse wiring or disconnection)</td></tr> <tr><td>EC</td><td>Startup time over</td></tr> <tr><td>E0~E7</td><td>Communication error except for outdoor unit</td></tr> </tbody> </table>	Display	Contents to be inspected (When power is turned on)	F3	63L connector(red) is open.	F5	63H connector(yellow) is open.	E8	Indoor/outdoor communication error (Signal receiving error) (Outdoor unit)	E9	Indoor/outdoor communication error (Transmitting error) (Outdoor unit)	EA	Miswiring of indoor/outdoor unit connecting wire, excessive number of indoor units (4 units or more)	Eb	Miswiring of indoor/outdoor unit connecting wire(converse wiring or disconnection)	EC	Startup time over	E0~E7	Communication error except for outdoor unit																																																	
Display	Contents to be inspected (When power is turned on)																																																																			
F3	63L connector(red) is open.																																																																			
F5	63H connector(yellow) is open.																																																																			
E8	Indoor/outdoor communication error (Signal receiving error) (Outdoor unit)																																																																			
E9	Indoor/outdoor communication error (Transmitting error) (Outdoor unit)																																																																			
EA	Miswiring of indoor/outdoor unit connecting wire, excessive number of indoor units (4 units or more)																																																																			
Eb	Miswiring of indoor/outdoor unit connecting wire(converse wiring or disconnection)																																																																			
EC	Startup time over																																																																			
E0~E7	Communication error except for outdoor unit																																																																			

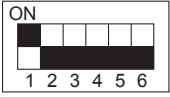
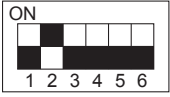
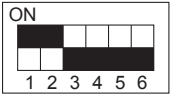
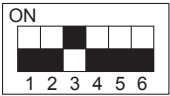
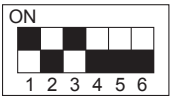
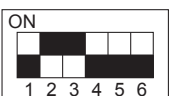
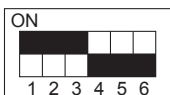
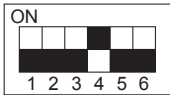
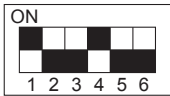

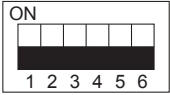
The black square (■) indicates a switch position.

SW2 setting	Display detail	Explanation for display	Unit
	Pipe temperature / Liquid (TH3) -40 to 194	-40 to 194 [-40 to 90°C] (When the coil thermistor detects 0°F [0°C] or below, “-” and temperature are displayed by turns.) Example: When -10°F; 0.5 s 0.5 s 2 s -□ → 10 → □□	°F [°C]
	Discharge temperature (TH4) 37 to 433	37 to 433 [3 to 217°C] (When the discharge thermistor detects 100°F or more, hundreds digit, tens digit and ones digit are displayed by turns.) Example: When 105°F; 0.5 s 0.5 s 2 s □1 → 05 → □□	°F [°C]
	Output step of outdoor FAN 0 to 10	0 to 10	Step
	The number of ON / OFF times of compressor 0 to 9999	0 to 9999 (When the number of times is 100 or more, hundreds digit, tens digit and ones digit are displayed by turns.) Example: When 42500 times (425 × 100 times); 0.5 s 0.5 s 2 s □4 → 25 → □□	100 times
	Compressor integrating operation times 0 to 9999	0 to 9999 (When it is 100 hours or more, hundreds digit, tens digit and ones digit are displayed by turns.) Example: When 2450 hours (245 × 10 hours); 0.5 s 0.5 s 2 s □4 → 25 → □□	10 hours
	Compressor operating current 0 to 50	0 to 50 Note: Omit the figures after the decimal fractions.	A
	Compressor operating frequency 0 to 255	0 to 255 (When it is 100 Hz or more, hundreds digit, tens digit and ones digit are displayed by turns.) Example: When 125 Hz; 0.5 s 0.5 s 2 s □1 → 25 → □□	Hz
	LEV-A opening pulse 0 to 480	0 to 480 (When it is 100 pulse or more, hundreds digit, tens digit and ones digit are displayed by turns.) Example: When 150 pulse; 0.5 s 0.5 s 2 s □1 → 50 → □□	Pulse
	Error postponement code history (1) of outdoor unit	Postponement code display Blinking: During postponement Lighting: Cancellation of postponement “00” is displayed in the case of no postponement.	Code display
	Operation mode on error occurring	Operation mode of when operation stops due to error is displayed by setting SW2 like below. (SW2) 	Code display

The black square (■) indicates a switch position.

SW2 setting	Display detail	Explanation for display	Unit
	Pipe temperature / Liquid(TH3) on error occurring -40 to 194	-40 to 194 [-40 to 90°C] (When the coil thermistor detects 0°F [0°C] or below, “-” and temperature are displayed by turns.) Example: When -15°F; 0.5 s 0.5 s 2 s -□ → 15 → □□ ↑—————↓	°F [°C]
	Compressor temperature (TH4) or discharge temperature (TH4) on error occurring 37 to 433	37 to 433 [3 to 217°C] (When the temperature is 100°F or more, the hundreds digit, tens digit and ones digit are displayed by turns.) Example: When 130°F; 0.5 s 0.5 s 2 s □1 → 30 → □□ ↑—————↓	°F [°C]
	Compressor operating current on error occurring 0 to 50	0 to 50	A
	Error history (1) (latest) Alternate display of abnormal unit number and code	When no error history, “0” and “-” are displayed by turns.	Code display
	Error history (2) Alternate display of error unit number and code	When no error history, “0” and “-” are displayed by turns.	Code display
	Thermostat ON time 0 to 999	0 to 999 (When it is 100 minutes or more, the hundreds digit, tens digit and ones digit are displayed by turns.) Example: When 245 minutes; 0.5 s 0.5 s 2 s □2 → 45 → □□ ↑—————↓	Minute
	Test run elapsed time 0 to 120	0 to 120 (When it is 100 minutes or more, the hundreds digit, tens digit and ones digit are displayed by turns.) Example: When 105 minutes; 0.5 s 0.5 s 2 s □1 → 05 → □□ ↑—————↓	Minute

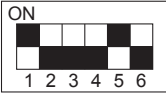
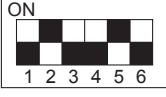
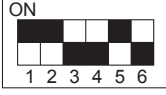
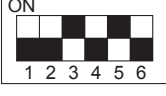
The black square (■) indicates a switch position.

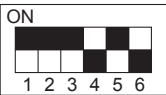
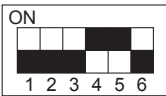
SW2 setting	Display detail	Explanation for display	Unit										
	The number of connected indoor units	0 to 3 (The number of connected indoor units are displayed.)	Unit										
	Capacity setting display	Displayed as an outdoor capacity code <table border="1" data-bbox="794 400 1023 538"> <thead> <tr> <th>Capacity</th> <th>Code</th> </tr> </thead> <tbody> <tr> <td>KA24</td> <td>11</td> </tr> <tr> <td>KA30</td> <td>14</td> </tr> <tr> <td>KA36</td> <td>20</td> </tr> </tbody> </table>	Capacity	Code	KA24	11	KA30	14	KA36	20	Code display		
Capacity	Code												
KA24	11												
KA30	14												
KA36	20												
	Outdoor unit setting information	<ul style="list-style-type: none"> The tens digit (Total display for applied setting) <table border="1" data-bbox="746 623 1313 751"> <thead> <tr> <th>Setting details</th> <th>Display details</th> </tr> </thead> <tbody> <tr> <td>H·P / Cooling only</td> <td>0: H·P 1: Cooling only</td> </tr> <tr> <td>Single phase / 3 phase</td> <td>0: Single phase 2: 3 phase</td> </tr> </tbody> </table> <ul style="list-style-type: none"> The ones digit <table border="1" data-bbox="746 804 1313 889"> <thead> <tr> <th>Setting details</th> <th>Display details</th> </tr> </thead> <tbody> <tr> <td>Defrosting switch</td> <td>0: Normal 1: For high humidity</td> </tr> </tbody> </table> <p>Example: When heat pump, 3 phase and defrosting (normal) are set up, "20" is displayed.</p>	Setting details	Display details	H·P / Cooling only	0: H·P 1: Cooling only	Single phase / 3 phase	0: Single phase 2: 3 phase	Setting details	Display details	Defrosting switch	0: Normal 1: For high humidity	Code display
Setting details	Display details												
H·P / Cooling only	0: H·P 1: Cooling only												
Single phase / 3 phase	0: Single phase 2: 3 phase												
Setting details	Display details												
Defrosting switch	0: Normal 1: For high humidity												
	Indoor pipe temperature/ Liquid (TH2(1)) Indoor 1 -38 to 190	-38 to 190 [-39 to 88°C] (When the temperature is 0°F [0°C] or less, "-" and temperature are displayed by turns.)	°F [°C]										
	Indoor pipe temperature/ Cond. / Eva. (TH5(1)) Indoor 1 -38 to 190	-38 to 190 [-39 to 88°C] (When the temperature is 0°F [0°C] or less, "-" and temperature are displayed by turns.)	°F [°C]										
	Indoor pipe temperature/ Liquid (TH2(2)) Indoor 2 -38 to 190	-38 to 190 [-39 to 88°C] (When the temperature is 0°F [0°C] or less, "-" and temperature are displayed by turns.)	°F [°C]										
	Indoor pipe temperature/ Cond./ Eva. (TH5(2)) Indoor 2 -38 to 190	-38 to 190 [-39 to 88°C] (When the temperature is 0°F [0°C] or less, "-" and temperature are displayed by turns.)	°F [°C]										
	Indoor room temperature (TH1) 46 to 102	46 to 102 [8 to 39°C]	°F [°C]										



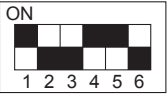
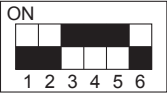
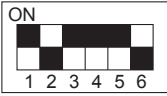
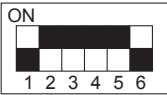
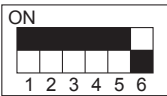
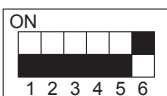
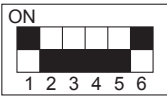
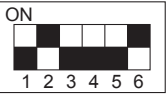
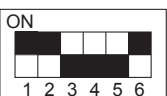

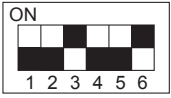
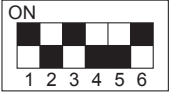
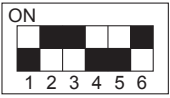
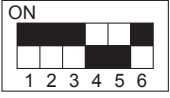
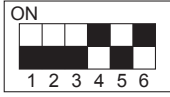
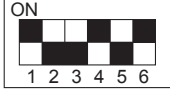
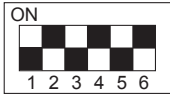
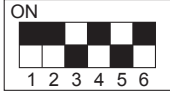

The black square (■) indicates a switch position.

SW2 setting	Display detail	Explanation for display	Unit														
	Indoor setting temperature 62 to 86	62 to 86 [17 to 30°C]	°F [°C]														
	Outdoor pipe temperature/2-phase (TH6) -38 to 190	-38 to 190 [-39 to 88°C] (When the temperature is 0°F [0°C] or less, “-” and temperature are displayed by turns.)	°F [°C]														
	Outdoor outside temperature (TH7) -38 to 190	-38 to 190 (-39 to 88°C) (When the temperature is 0°F [0°C] or less, “-” and temperature are displayed by turns.)	°F [°C]														
	Outdoor heatsink temperature (TH8) -40 to 327	-40 to 327 [-40 to 164°C] (When the temperature is 0°F [0°C] or less, “-” and temperature are displayed by turns.) (When the thermistor detects 100°F or more, hundreds digit, tens digit and ones digit are displayed by turns.)	°F [°C]														
	Discharge superheat. SHd 0 to 458 [Cooling = [Higher temperature of TH4 or TH32] -TH6 Heating = [Higher temperature of TH4 or TH32] -TH5]	0 to 458 [0 to 255°C] (When the temperature is 100°F or more, hundreds digit, tens digit and ones digit are displayed by turns.)	°F [°C]														
	Number of defrost cycles 0 to FFFE	0 to FFFE (in hexadecimal notation) (When more than FF in hex (255 in decimal), the number is displayed in order of 16 ³ 's and 16 ² 's, and 16 ¹ 's and 16 ⁰ 's places. Example: When 5000 cycles; 0.5 s 0.5 s 2 s □9 → C4 → □□	2 cycles														
	Input current of outdoor unit	0 to 500 (When it is 100 or more, hundreds digit, tens digit and ones digit are displayed by turns.)	0.1 A														
	LEV-B opening pulse 0 to 480	0 to 480 (When it is 100 pulse or more, hundreds digit, tens digit and ones digit are displayed by turns.)	Pulse														
	U9 error detail history (latest)	<table border="1" data-bbox="823 1672 1382 1889"> <thead> <tr> <th>Description</th> <th>Display</th> </tr> </thead> <tbody> <tr> <td>Normal</td> <td>00</td> </tr> <tr> <td>Overvoltage error</td> <td>01</td> </tr> <tr> <td>Undervoltage error</td> <td>02</td> </tr> <tr> <td>Input current sensor error</td> <td>04</td> </tr> <tr> <td>Abnormal power synchronous signal</td> <td>08</td> </tr> <tr> <td>PFC error (Overvoltage/Undervoltage/Overcurrent)</td> <td>10</td> </tr> </tbody> </table> <p>• Display examples for multiple errors: Overvoltage (01) + Undervoltage (02) = 03 Undervoltage (02) + Power-sync signal error (08) = 0A L1 phase open error (04) + PFC error (10) = 14</p>	Description	Display	Normal	00	Overvoltage error	01	Undervoltage error	02	Input current sensor error	04	Abnormal power synchronous signal	08	PFC error (Overvoltage/Undervoltage/Overcurrent)	10	Code display
Description	Display																
Normal	00																
Overvoltage error	01																
Undervoltage error	02																
Input current sensor error	04																
Abnormal power synchronous signal	08																
PFC error (Overvoltage/Undervoltage/Overcurrent)	10																

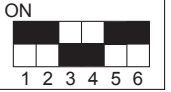
The black square (■) indicates a switch position.

SW2 setting	Display detail	Explanation for display	Unit
	DC bus voltage 180 to 760	180 to 760 (When it is 100 V or more, hundreds digit, tens digit and ones digit are displayed by turns.)	V
	Capacity save 0 to 100 When air conditioner is connected to M-NET and capacity save mode is demanded, a value from "0" to "100" is displayed. [When there is no setting of capacity save, "100" is displayed.]	0 to 100 (When the capacity is 100%, hundreds digit, tens digit and ones digit are displayed by turns.) Example: When 100%; 0.5 s 0.5 s 2 s □1 → 00 → □□	%
	Error postponement code history (2) of outdoor unit	Postponement code display Blinking: During postponement Lighting: Cancellation of postponement "00" is displayed in the case of no postponement.	Code display
	Error postponement code history (3) of outdoor unit	Postponement code display Blinking: During postponement Lighting: Cancellation of postponement "00" is displayed in the case of no postponement.	Code display
	Error history (3) (Oldest) Alternate display of abnormal unit number and code.	When no error history, "0" and "--" are displayed by turns.	Code display
	Error thermistor display [When there is no error thermistor, "--" is displayed.]	3: Liquid pipe temperature (TH3) 4: Discharge pipe temperature (TH4) 6: 2-phase pipe temperature (TH6) 7: Ambient temperature (TH7) 8: Heat sink temperature (TH8) 32: Suction pipe temperature (TH32) 34: Comp. surface temperature (TH33)	Code display
	Operation frequency on error occurring 0 to 255	0 to 255 (When it is 100 Hz or more, hundreds digit, tens digit and ones digit are displayed by turns.) Example: When 125 Hz; 0.5 s 0.5 s 2 s □1 → 25 → □□	Hz
	Fan step on error occurring 0 to 10	0 to 10	Step

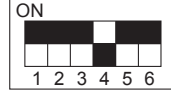
The black square (■) indicates a switch position.

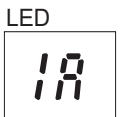
SW2 setting	Display detail	Explanation for display	Unit																
	<p>Discharge superheat on error occurring SHd 0 to 327</p> <p>Cooling = [Higher temperature of TH4 or TH32] -TH6 Heating = [Higher temperature of TH4 or TH32] -TH5</p>	<p>0 to 327 [0 to 182°C] (When the temperature is 100°F or more, hundreds digit, tens digit and ones digit are displayed by turns.) Example: When 150°F ;</p> <p>0.5 s 0.5 s 2 s □1 → 50 → □□</p>	°F [°C]																
	<p>Sub cool on error occurring. SC 0 to 234</p> <p>Cooling = TH6 - TH3 Heating = TH5 - TH2</p>	<p>0 to 234 [0 to 130°C] (When the temperature is 100°F or more, hundreds digit, tens digit and ones digit are displayed by turns.) Example: When 115°F;</p> <p>0.5 s 0.5 s 2 s □1 → 15 → □□</p>	°F [°C]																
	<p>Thermo-on time until error stops 0 to 999</p>	<p>0 to 999 (When it is 100 minutes or more, hundreds digit, tens digit and ones digit are displayed by turns.) Example: When 415 minutes;</p> <p>0.5 s 0.5 s 2 s □4 → 15 → □□</p>	Minute																
	<p>Indoor pipe temperature / Liquid (TH2 (3)) Indoor 3 -38 to 190</p>	<p>-38 to 190 [-39 to 88°C] (When the temperature is 0°F [°C] or less, “-” and temperature are displayed by turns.)</p>	°F [°C]																
	<p>Indoor pipe temperature / Cond./ Eva. (TH5 (3)) Indoor 3 -38 to 190</p>	<p>-38 to 190 [-39 to 88°C] (When the temperature is 0°F [°C] or less, “-” and temperature are displayed by turns.)</p> <p>When there is no indoor unit, “00” is displayed.</p>	°F [°C]																
	<p>Controlling status of compressor operating frequency</p>	<p>The following code will be a help to know the operating status of unit.</p> <ul style="list-style-type: none"> •The tens digit <table border="1" data-bbox="774 1383 1220 1478"> <thead> <tr> <th>Display</th> <th>Compressor operating frequency control</th> </tr> </thead> <tbody> <tr> <td>1</td> <td>Primary current control</td> </tr> <tr> <td>2</td> <td>Secondary current control</td> </tr> </tbody> </table> <ul style="list-style-type: none"> •The ones digit (In this digit, the total number of activated control is displayed.) <table border="1" data-bbox="774 1553 1220 1798"> <thead> <tr> <th>Display</th> <th>Compressor operating frequency control</th> </tr> </thead> <tbody> <tr> <td>1</td> <td>Preventive control for excessive temperature rise of discharge temperature</td> </tr> <tr> <td>2</td> <td>Preventive control for excessive temperature rise of condensing temperature</td> </tr> <tr> <td>4</td> <td>Frost preventing control</td> </tr> <tr> <td>8</td> <td>Preventive control for excessive temperature rise of radiator panel</td> </tr> </tbody> </table> <p>(Example) The following controls are activated.</p> <ul style="list-style-type: none"> • Primary current control • Preventive control for excessive temperature rise of condensing temperature • Preventive control for excessive temperature rise of heatsink 	Display	Compressor operating frequency control	1	Primary current control	2	Secondary current control	Display	Compressor operating frequency control	1	Preventive control for excessive temperature rise of discharge temperature	2	Preventive control for excessive temperature rise of condensing temperature	4	Frost preventing control	8	Preventive control for excessive temperature rise of radiator panel	Code display
Display	Compressor operating frequency control																		
1	Primary current control																		
2	Secondary current control																		
Display	Compressor operating frequency control																		
1	Preventive control for excessive temperature rise of discharge temperature																		
2	Preventive control for excessive temperature rise of condensing temperature																		
4	Frost preventing control																		
8	Preventive control for excessive temperature rise of radiator panel																		

The black square (■) indicates a switch position.

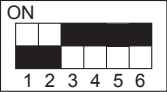
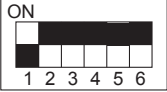
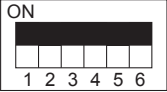
SW2 setting	Display detail	Explanation for display	Unit
	<p>Outdoor suction pipe temperature (TH32) -38 to 190</p>	<p>-38 to 190 [-39 to 88°C] (When the temperature is 0°F [0°C] or less, “-” and temperature are displayed by turns.) Example: When -15°C; 0.5 s 0.5 s 2 s -□ → 15 → □□ ↑—————↓</p>	°F [°C]
	<p>Indoor pipe temperature / Liquid (TH2 (4)) Indoor 4 -38 to 190</p>	<p>-38 to 190 [-39 to 88°C] (When the temperature is 0°F [°C] or less, “-” and temperature are displayed by turns.)</p>	°F [°C]
	<p>Indoor pipe temperature / Cond./ Eva. (TH5 (4)) Indoor 4 -38 to 190</p>	<p>-38 to 190 [-39 to 88°C] (When the temperature is 0°F [°C] or less, “-” and temperature are displayed by turns.) When there is no indoor unit, “00” is displayed.</p>	°F [°C]

11-1. SMOOTH MAINTENANCE

<PAR-4xMAA ("x" represents 0 or later)>

Refer to "15-9. SMOOTH MAINTENANCE" for operation procedure.

Maintenance data, such as the indoor/outdoor unit's heat exchanger temperature and compressor operation current can be displayed with "Smooth maintenance".

This cannot be executed during test operation.

Depending on the combination with the outdoor unit, this may not be supported by some models.

- Reduces maintenance work drastically.
- Enables you to check operation data of the indoor and outdoor units by remote controller. Furthermore, use of maintenance stable-operation control that fixes the operating frequency, allows smooth inspection, even for inverter models.

Smooth Maintenance Function

Smooth maintenance 2/3

Ref.address 0 Cool

Sub cool 3°C

OU TH4 temp. 68°C

OU TH6 temp. 38°C

OU TH7 temp. 38°C

Return: RETURN

▼ Page ▲

Discharge temperature 60°C

● Conventional inspection work

●Outdoor unit ●



Remove the service panel.

●Indoor unit ●



Measure the intake air temperature.

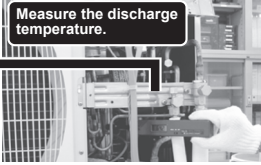

Measure the discharge temperature.



Measure the outside air temperature.

Easy maintenance information (unit)

Compressor		Outdoor unit	Indoor unit
①	Accumulated operating time (×10 hours)	④	Heat exchanger temperature (°C)
②	Number of ON/OFF times (×10 times)	⑤	Discharge temperature (°C)
③	Operating current (A)	⑥	Outside air temperature (°C)
		⑦	Intake air temperature (°C)
		⑧	Heat exchanger temperature (°C)
		⑨	Filter operating time* (Hours)

* The filter operating time is the time that has elapsed since the filter was reset.

11-2. Guide for operation condition

Checkpoints

Enter the temperature differences between ⑤, ④, ⑦ and ⑧ into the graph given below.
 Operation state is determined according to the plotted areas on the graph.
 For data measurements, set the fan speed to "Hi" before activating maintenance mode.

Inspection item		Result		
Power supply	Loose connection	Breaker	Good	Retightened
		Outdoor Unit	Good	Retightened
		Indoor Unit	Good	Retightened
		(Insulation resistance)		MΩ
	(Voltage)		V	
Compressor	① Accumulated operating time		Time	
	② Number of ON/OFF times		Times	
	③ Current		A	
Outdoor Unit	Temperature	④ Refrigerant/heat exchanger temperature	COOL °C	HEAT °C
		⑤ Refrigerant/discharge temperature	COOL °C	HEAT °C
		⑥ Air/outside air temperature	COOL °C	HEAT °C
		(Air/discharge temperature)	COOL °C	HEAT °C
	Cleanliness	Appearance	Good	Cleaning required
		Heat exchanger	Good	Cleaning required
Indoor Unit	Temperature	⑦ Air/intake air temperature	COOL °C	HEAT °C
		(Air/discharge temperature)	COOL °C	HEAT °C
		⑧ Refrigerant/heat exchanger temperature	COOL °C	HEAT °C
		⑨ Filter operating time*		Time
	Cleanliness	Decorative panel	Good	Cleaning required
		Filter	Good	Cleaning required
		Fan	Good	Cleaning required
		Heat exchanger	Good	Cleaning required
		Sound/vibration	None	Present

Classification	Item	Result	
Cool	Inspection	Is "D000" displayed stably on the remote controller?	
	Temperature difference	Stable	Unstable
Heat	Inspection	Is "D000" displayed stably on the remote controller?	
	Temperature difference	Stable	Unstable

Notes:

- Fixed Hz operation may not be possible under the following temperature ranges.
 - A) In cool mode, outdoor intake air temperature is 40 °C or higher or indoor intake air temperature is 23 °C or lower.
 - B) In heat mode, outdoor intake air temperature is 20 °C or higher or indoor intake air temperature is 25 °C or lower.
- If the air conditioner is operated at a temperature range other than the ones above but operation is not stabilized after 30 minutes or more have elapsed, carry out inspection.
- In heat mode, the operation state may vary due to frost forming on the outdoor heat exchanger.

* The filter operating time is the time that has elapsed since the filter was reset.

Cool mode

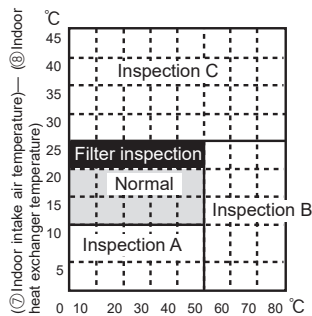

(⑤ Discharge temperature) - (④ Outdoor heat exchanger temperature)

Heat mode

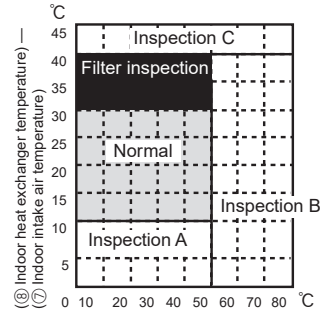

(⑤ Discharge temperature) - (⑧ Indoor heat exchanger temperature)

Result

Area	Check item	Judgement	
		Cool	Heat
Normal	Normal operation state		
Filter inspection	Filter may be clogged. *1		
Inspection A	Performance has dropped. Detailed inspection is necessary.		
Inspection B	Refrigerant amount is dropping.		
Inspection C	Filter or indoor heat exchanger may be clogged.		

Note:

The above judgement is just guide based on Japanese standard conditions. It may be changed depending on the indoor and outdoor temperature.

*1 It may be judged as "Filter inspection" due to the outdoor and indoor temperature, even though it is not clogged.

12-1. UNIT FUNCTION SETTING BY THE REMOTE CONTROLLER

Each function can be set as necessary using the remote controller. The setting of function for each unit can only be done by the remote controller. Select function available from the table 1.

(1) Functions available when setting the unit number to 00 (Select 00 referring to ④ setting the indoor unit number.)

<Table 1> Function selections

Function	Settings	Mode No.	Setting No.	● : Initial setting (when sent from the factory)	Remarks
		Wired remote controller (RF thermostat)			
Power failure automatic recovery	Not available	01	1		The setting is applied to all the units in the same refrigerant system.
	Available	(101)	2	●	
Indoor temperature detection	Average data from each indoor unit	02	1	●	
	Data from the indoor unit with remote controllers	(-)	2		
	Data from main remote controller		3		
LOSSNAY connectivity	Not supported	03	1	●	
	Supported (indoor unit dose not intake outdoor air through LOSSNAY)	(103)	2		
	Supported (indoor unit intakes outdoor air through LOSSNAY)		3		
Power supply voltage	230V	04	1	●	
	208V	(104)	2		
Frost prevention temperature	36°F [2°C] (Normal)	15	1	●	
	37°F [3°C]	(115)	2		
Humidifier control	When the compressor operates, the humidifier also operates.	16	1	●	
	When the fan operates, the humidifier also operates.	(116)	2		
Change of defrosting control	Standard	17	1	●	
	For high humidity	(117)	2		

<Table 2> Meaning of "Function setting"
Mode 02: indoor temperature detecting

No.	Indoor temperature (ta)=		Diagram 1	Diagram 2	Diagram 3	Diagram 4
No.1	Average data of the sensor on all the indoor units	Initial setting	Diagram 1: ta=(A+B)/2	Diagram 2: ta=(A+B)/2	Diagram 3: ta=A	Diagram 4: ta=A
No.2	Data of the sensor on the indoor unit that connected with remote controller	Initial setting	Diagram 1: ta=A	Diagram 2: ta=B	Diagram 3: ta=A	Diagram 4: ta=A
No.3	Data of the sensor on main remote controller	Initial setting	Diagram 1: ta=C	Diagram 2: ta=C	Diagram 3: ta=C	Diagram 4: ta=C

- (2) Functions available when setting the unit number to 01-03 or AL (07 in the case of the IR wireless remote controller)
- When setting functions for an indoor unit in an independent system, set the unit number to 01 referring to ④ setting the indoor unit number.
 - When setting functions for a simultaneous twin indoor unit system, set the unit number to 01 to 03 for each indoor unit in the case of selecting different functions for each unit referring to ④ setting the indoor unit number.
 - When setting the same functions for an entire simultaneous Twin-indoor unit system, set refrigerant address to AL (07 in the case of the IR wireless remote controller) referring to ④ setting the indoor unit number.

<Table 3> Available functions and settings

Function	Settings	Mode No. Wired remote controller (RF thermostat)	Setting No.	● : Initial setting (Factory setting)		Check
				Ceiling suspended	Multi position	
				PEAD-A·AA	SVZ-KP·NA	
Filter sign	100h	07 (107)	1			
	2500h		2			
	No filter sign indicator		3	●	●	
External static pressure	5/15/35/50Pa (0.02/0.06/0.14/0.20in.WG)	08 (108)		Refer to the table below	Refer to the table below	
		10 (110)		Refer to the table below	Refer to the table below	
Heater control *2	No heater present	11 (111)	1	●	●	
	Heater present		2			
	SEZ, SLZ :Set temp -4.5°F ON PEAD, SVZ :Heater not operation in Defrost/Error	23 (123)	1	●	●	
	SEZ, SLZ :Set temp -1.8°F ON PEAD, SVZ :Heater not operation in Defrost/Error*4		2			
Set temperature in heating mode *3	Available	24 (124)	1	●	●	
	Not available		2			
Fan speed during the heating thermo OFF	Extra low	25 (125)	1	●	●	
	Stop		2			
	Set fan speed		3			
Fan speed during the cooling thermo OFF	Set fan speed	27 (127)	1	●	●	
	Stop		2			
Detection of abnormality of the pipe temperature (P8)	Available	28 (128)	1			
	Not available		2	●	●	

*2 For the detail of Heater control, refer to the service manual.

*3 4 degC (7.2 degF) up

*4 Depend on the error, heater may not operate please refer to SVZ service manual.

External static pressure setting for SVZ (Vertical, Horizontal left, Horizontal right position*).

External static pressure	Setting No.		● : Initial setting (Factory setting)	Check
	Mode No. 08	Mode No. 10		
75Pa (0.3in.WG)	1	1		
125Pa (0.5in.WG)	2	1	●	
200Pa (0.8in.WG)	3	1		

* Regarding to down flow setting, please refer to down flow kit installation manual.

External static pressure setting for PEAD.

External static pressure	Setting No.		● : Initial setting (Factory setting)	Check
	Mode No. 08	Mode No. 10		
35Pa (0.14in.WG)	2	1		
50Pa (0.20in.WG)	3	1	●	
70Pa (0.28in.WG)	1	2		
100Pa (0.40in.WG)	2	2		
150Pa (0.60in.WG)	3	2		

12-2. SELECTING FUNCTIONS USING THE REMOTE CONTROLLER

Refer to "15-3. SERVICE MENU" and "15-5. FUNCTION SETTING" when selecting functions.

13-1. HOW TO "MONITOR THE OPERATION DATA"

Refer to "15-10. REQUEST CODE" when monitoring the operation data.

13-2. REQUEST CODE LIST

Certain indoor/outdoor combinations do not have the request code function; therefore, no request codes are displayed.

Request code	Request content	Description (Display range)	Unit	Remarks
0	Operation state	Refer to 13-2-1. Detail Contents in Request Code.	–	
1	Compressor-Operating current (rms)	0 – 50	A	
2	Compressor-Accumulated operating time	0 – 9999	10 hours	
3	Compressor-Number of operation times	0 – 9999	100 times	
4	Discharge temperature (TH4)	37 – 327	°F	
5	Outdoor unit - Liquid pipe 1 temperature (TH3)	-40 – 194	°F	
6	Outdoor unit - Liquid pipe 2 temperature	-40 – 194	°F	
7	Outdoor unit-2-phase pipe temperature (TH6)	-38 – 190	°F	
8	Outdoor suction pipe temperature (TH32)	-38 – 190	°F	
9	Outdoor unit-Ambient air temperature (TH7)	-38 – 190	°F	
10	Outdoor unit-Heatsink temperature (TH8)	-40 – 327	°F	
11				
12	Discharge superheat (SHd)	0 – 327	°F	
13	Sub-cool (SC)	0 – 234	°F	
14				
15				
16	Compressor-Operating frequency	0 – 255	Hz	
17	Compressor-Target operating frequency	0 – 255	Hz	
18	Outdoor unit-Fan output step	0 – 10	Step	
19	Outdoor unit-Fan 1 speed (Only for air conditioners with DC fan motor)	0 – 9999	rpm	
20	Outdoor unit-Fan 2 speed (Only for air conditioners with DC fan motor)	0 – 9999	rpm	"0" is displayed if the air conditioner is a single-fan type.
21				
22	LEV (A) opening	0 – 500	Pulses	
23	LEV (B) opening	0 – 500	Pulses	
24	LEV (C) opening	0 – 500	Pulses	
25	Primary current	0 – 50	A	
26	DC bus voltage	180 – 370	V	
27				
28				
29	Number of connected indoor units	0 – 4	Units	
30	Indoor unit-Setting temperature	62 – 86	°F	
31	Indoor unit-Intake air temperature <Measured by thermostat>	46 – 102	°F	
32	Indoor unit-Intake air temperature (Unit No. 1) <Heat mode-4 degree correction>	46 – 102	°F	"0" is displayed if the target unit is not present.
33	Indoor unit-Intake air temperature (Unit No. 2) <Heat mode-4 degree correction>	46 – 102	°F	↑
34	Indoor unit-Intake air temperature (Unit No. 3) <Heat mode-4 degree correction>	46 – 102	°F	↑
35	Indoor unit-Intake air temperature (Unit No. 4) <Heat mode-4 degree correction>	46 – 102	°F	↑
36				
37	Indoor unit - Liquid pipe temperature (Unit No. 1)	-38 – 190	°F	"0" is displayed if the target unit is not present.
38	Indoor unit - Liquid pipe temperature (Unit No. 2)	-38 – 190	°F	↑
39	Indoor unit - Liquid pipe temperature (Unit No. 3)	-38 – 190	°F	↑
40	Indoor unit - Liquid pipe temperature (Unit No. 4)	-38 – 190	°F	↑
41				
42	Indoor unit-Cond./Eva. pipe temperature (Unit No. 1)	-38 – 190	°F	"0" is displayed if the target unit is not present.
43	Indoor unit-Cond./Eva. pipe temperature (Unit No. 2)	-38 – 190	°F	↑
44	Indoor unit-Cond./Eva. pipe temperature (Unit No. 3)	-38 – 190	°F	↑
45	Indoor unit-Cond./Eva. pipe temperature (Unit No. 4)	-38 – 190	°F	↑

Request code	Request content	Description (Display range)	Unit	Remarks
46				
47				
48	Thermostat ON operating time	0 – 999	Minutes	
49	Test run elapsed time	0 – 120	Minutes	◀ Not possible to activate maintenance mode during the test run.
50	Indoor unit-Control state	Refer to 13-2-1.Detail Contents in Request Code.	–	
51	Outdoor unit-Control state	Refer to 13-2-1.Detail Contents in Request Code.	–	
52	Compressor-Frequency control state	Refer to 13-2-1.Detail Contents in Request Code.	–	
53	Outdoor unit-Fan control state	Refer to 13-2-1.Detail Contents in Request Code.	–	
54	Actuator output state	Refer to 13-2-1.Detail Contents in Request Code.	–	
55	Error content (U9)	Refer to 13-2-1.Detail Contents in Request Code.	–	
56				
57				
58				
59				
60	Signal transmission demand capacity	0 – 255	%	
61	Contact demand capacity	Refer to 13-2-1.Detail Contents in Request Code.	–	
62	External input state (silent mode, etc.)	Refer to 13-2-1.Detail Contents in Request Code.	–	
63				
64				
65				
66				
67				
68				
69				
70	Outdoor unit-Capacity setting display	Refer to 13-2-1.Detail Contents in Request Code.	–	
71	Outdoor unit-Setting information	Refer to 13-2-1.Detail Contents in Request Code.	–	
72				
73	Outdoor unit-SW1 setting information	Refer to 13-2-1.Detail Contents in Request Code.	–	
74	Outdoor unit-SW2 setting information	Refer to 13-2-1.Detail Contents in Request Code.	–	
75				
76	Outdoor unit-SW4 setting information	Refer to 13-2-1.Detail Contents in Request Code.	–	
77	Outdoor unit-SW5 setting information	Refer to 13-2-1.Detail Contents in Request Code.	–	
78	Outdoor unit-SW6 setting information	Refer to 13-2-1.Detail Contents in Request Code.	–	
79	Outdoor unit-SW7 setting information	Refer to 13-2-1.Detail Contents in Request Code.	–	
80	Outdoor unit-SW8 setting information	Refer to 13-2-1.Detail Contents in Request Code.	–	
81	Outdoor unit-SW9 setting information	Refer to 13-2-1.Detail Contents in Request Code.	–	
82	Outdoor unit-SW10 setting information	Refer to 13-2-1.Detail Contents in Request Code.	–	
83				
84	M-NET adapter connection (presence/absence)	"0000": Not connected "0001": Connected	–	
85				
86				
87				
88				
89	Display of execution of replace/wash operation	"0000": Not washed "0001": Washed	–	
90	Outdoor unit-Microprocessor version information	Examples) Ver 5.01 → "0501"	Ver	
91	Outdoor unit-Microprocessor version information (sub No.)	Auxiliary information (displayed after version information) Examples) Ver 5.01 A000 → "A000"	–	
92				
93				
94				
95				
96				
97				
98				
99				

Request code	Request content	Description (Display range)	Unit	Remarks
100	Outdoor unit - Error postponement history 1 (latest)	Displays postponement code. (" - " is displayed if no postponement code is present)	Code	
101	Outdoor unit - Error postponement history 2 (previous)	Displays postponement code. (" - " is displayed if no postponement code is present)	Code	
102	Outdoor unit - Error postponement history 3 (last but one)	Displays postponement code. (" - " is displayed if no postponement code is present)	Code	
103	Error history 1 (latest)	Displays error history. (" - " is displayed if no history is present.)	Code	
104	Error history 2 (second to last)	Displays error history. (" - " is displayed if no history is present.)	Code	
105	Error history 3 (third to last)	Displays error history. (" - " is displayed if no history is present.)	Code	
106	Abnormal thermistor display (TH3/TH6/TH7/TH8)	3: TH3 6: TH6 7: TH7 8: TH8 0: No thermistor error	Sensor number	
107	Operation mode at time of error	Displayed in the same way as request code "0".	—	
108	Compressor-Operating current at time of error	0 – 50	A	
109	Compressor-Accumulated operating time at time of error	0 – 9999	10 hours	
110	Compressor-Number of operation times at time of error	0 – 9999	100 times	
111	Discharge temperature at time of error	37 – 327	°F	
112	Outdoor unit - Liquid pipe 1 temperature (TH3) at time of error	-40 – 194	°F	
113	Outdoor unit - Liquid pipe 2 temperature at time of error	-40 – 194	°F	
114	Outdoor unit-2-phase pipe temperature (TH6) at time of error	-38 – 190	°F	
115				
116	Outdoor unit-Outside air temperature (TH7) at time of error	-38 – 190	°F	
117	Outdoor unit-Heat sink temperature (TH8) at time of error	-40 – 327	°F	
118	Discharge super heat (SHd) at time of error	0 – 327	°F	
119	Sub-cool (SC) at time of error	0 – 234	°F	
120	Compressor-Operating frequency at time of error	0 – 255	Hz	
121	Outdoor unit at time of error · Fan output step	0 – 10	Step	
122	Outdoor unit at time of error · Fan 1 speed (Only for air conditioners with DC fan)	0 – 9999	rpm	
123	Outdoor unit at time of error · Fan 2 speed (Only for air conditioners with DC fan)	0 – 9999	rpm	"0" is displayed if the air conditioner is a single-fan type.
124				
125	LEV (A) opening at time of error	0 – 500	Pulses	
126	LEV (B) opening at time of error	0 – 500	Pulses	
127				
128				
129				
130	Thermostat ON time until operation stops due to error	0 – 999	Minutes	
131				
132	Indoor - Liquid pipe temperature at time of error	-38 – 190	°F	Average value of all indoor units is displayed if the air conditioner consists of 2 or more indoor units (twin).
133	Indoor-Cond./Eva. pipe temperature at time of error	-38 – 190	°F	Average value of all indoor units is displayed if the air conditioner consists of 2 or more indoor units (twin).
134	Indoor at time of error · Intake air temperature <Thermostat judge temperature>	-38 – 190	°F	
135				
136				
137				
138				
139				
140				
to				
146				
147				
148				
149				

Request code	Request content	Description (Display range)	Unit	Remarks
150	Indoor-Actual intake air temperature	-38 – 190	°F	
151	Indoor - Liquid pipe temperature	-38 – 190	°F	
152	Indoor-Cond./Eva. pipe temperature	-38 – 190	°F	
153				
154	Indoor-Fan operating time (After filter is reset)	0 – 9999	1 hour	
155	Indoor-Total operating time (Fan motor ON time)	0 – 9999	10 hours	
156				
157	Indoor fan output value (Sj value)	0 – 255 Fan control data	–	For indoor fan phase control
158	Indoor fan output value (Pulsation ON/OFF)	"00 *** ****" indicates fan control data.	–	For indoor fan pulsation control
159	Indoor fan output value (duty value)	"00 *** ****" indicates fan control data.	–	For indoor DC brushless motor control
160				
161				
162	Indoor unit-Model setting information	Refer to 13-2-1. Detail Contents in Request Code.	–	
163	Indoor unit-Capacity setting information	Refer to 13-2-1. Detail Contents in Request Code.	–	
164	Indoor unit-SW3 information	Undefined	–	
165	Wireless pair No. (indoor control board side) setting	Refer to 13-2-1. Detail Contents in Request Code.	–	
166	Indoor unit-SW5 information	Undefined	–	
167				
~				
189				
190	Indoor unit-Microprocessor version information	Examples) Ver 5.01 → "0501"	Ver	
191	Indoor unit-Microprocessor version information (sub No.)	Auxiliary information (displayed after version information) Examples) Ver 5.01 A000 → "A000"	–	
192				
~				
764				
765	Stable operation (Heat mode)	This request code is not provided to collect data. It is used to fix the operation state.		
766	Stable operation (Cool mode)	This request code is not provided to collect data. It is used to fix the operation state.		
767	Stable operation cancellation	This request code is not provided to collect data. It is used to cancel the operation state that has been fixed by request codes "765" and "766".		

13-2-1. Detail Contents in Request Code

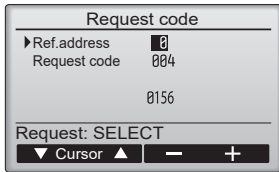

[Example) Request code "004"
Discharge temperature 156°F
Refrigerant address "00"]

[Operation state] (Request code: "0")

Data display

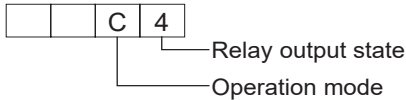

Operation mode

Display	Operation mode
0	STOP • FAN
C	COOL • DRY
H	HEAT
d	DEFROST

Relay output state

Display	Power currently supplied to compressor	Compressor	Four-way valve	Solenoid valve
0	—	—	—	—
1				ON
2			ON	
3			ON	ON
4		ON		
5		ON		ON
6		ON	ON	
7		ON	ON	ON
8	ON			
A	ON		ON	

[Indoor unit – Control state] (Request code: "50")

Data display

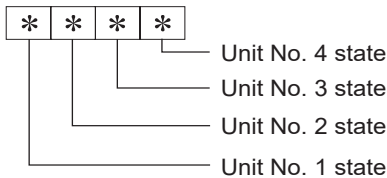

Display	State
0	Normal
1	Preparing for heat operation.
2	—
3	—
4	Heater is ON.
5	Anti-freeze protection is ON.
6	Overheat protection is ON.
7	Requesting compressor to turn OFF.
F	There are no corresponding units.

[Outdoor unit – Control state] (Request code: "51")

Data display	State
0 0 0 0	Normal
0 0 0 1	Preparing for heat operation.
0 0 0 2	Defrost

[Compressor – Frequency control state] (Request code: "52")

Data display

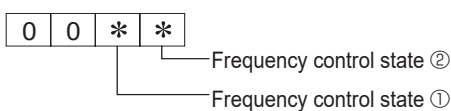

Frequency control state ①

Display	Current limit control
0	No current limit
1	Primary current limit control is ON.
2	Secondary current limit control is ON.

Frequency control state ②

Display	Discharge temperature overheat prevention	Condensation temperature overheat prevention	Anti-freeze protection control	Heatsink temperature overheat prevention
0				
1	Controlled			
2		Controlled		
3	Controlled	Controlled		
4			Controlled	
5	Controlled		Controlled	
6		Controlled	Controlled	
7	Controlled	Controlled	Controlled	
8				Controlled
9	Controlled			Controlled
A		Controlled		Controlled
b	Controlled	Controlled		Controlled
C			Controlled	Controlled
d	Controlled		Controlled	Controlled
E		Controlled	Controlled	Controlled
F	Controlled	Controlled	Controlled	Controlled

[Fan control state] (Request code: "53")

Data display

0	0	*	*
---	---	---	---

└─ Fan step correction value by heatsink temperature overhear prevention control
└─ Fan step correction value by cool condensation temperature overhear prevention control

Display	Correction value
- (minus)	- 1
0	0
1	+1
2	+2

[Actuator output state] (Request code: "54")

Data display

0	0	*	*
---	---	---	---

└─ Actuator output state ①
└─ Actuator output state ②

Actuator output state ①

Display	SV1	Four-way valve	Compressor	Compressor is warming up
0				
1	ON			
2		ON		
3	ON	ON		
4			ON	
5	ON		ON	
6		ON	ON	
7	ON	ON	ON	
8				ON
9	ON			ON
A		ON		ON
b	ON	ON		ON
C			ON	ON
d	ON		ON	ON
E		ON	ON	ON
F	ON	ON	ON	ON

Actuator output state ②

Display	52C	SV2	SS
0			
1	ON		
2		ON	
3	ON	ON	
4			ON
5	ON		ON
6		ON	ON
7	ON	ON	ON

[Error content (U9)] (Request code: "55")

Data display

0	0	*	*
---	---	---	---

└─ Error content ①
└─ Error content ②

Error content ①

● : Detected

Display	Ovoltage error	Undervoltage error	L1-phase open error	Power synchronizing signal error
0				
1	●			
2		●		
3	●	●		
4			●	
5	●		●	
6		●	●	
7	●	●	●	
8				●
9	●			●
A		●		●
b	●	●		●
C			●	●
d	●		●	●
E		●	●	●
F	●	●	●	●

Error content ②

● : Detected

Display	Converter Fo error	PAM error
0		
1	●	
2		●
3	●	●

[Contact demand capacity] (Request code: "61")

Data display

0	0	0	*
---	---	---	---

 Setting content

Setting content

Display	Setting value	Setting	
		SW7-1	SW7-2
0	0%		
1	50%	ON	
2	75%		ON
3	100%	ON	ON

[External input state] (Request code: "62")

Data display

0	0	0	*
---	---	---	---

 Input state

Input state

● : Input position

Display	Contact demand input	Silent mode input	Spare 1 input	Spare 2 input
0				
1	●			
2		●		
3	●	●		
4			●	
5	●		●	
6		●	●	
7	●	●	●	
8				●
9	●			●
A		●		●
b	●	●		●
C			●	●
d	●		●	●
E		●	●	●
F	●	●	●	●

[Outdoor unit – Capacity setting display] (Request code: "70")

Data display	Capacity
9	12
10	18
11	24
14	30
20	36
25	42

[Outdoor unit – Setting information] (Request code: "71")

Data display

0	0	*	*
---	---	---	---

 Setting information ①
Setting information ②

Setting information ①

Display	Defrost mode
0	Standard
1	For high humidity

Setting information ②

Display	Single-/three-phase	Heat pump/cooling only
0	Single-phase	Heat pump
1		Cooling only
2	Three-phase	Heat pump
3		Cooling only

[Outdoor unit switch setting display (SW1 to SW10, except SW3)] Request codes: "73 to 82"

0: Switch OFF 1: Switch ON

SW1, SW2, SW6, SW7						Data display
1	2	3	4	5	6	
0	0	0	0	0	0	00 00
1	0	0	0	0	0	00 01
0	1	0	0	0	0	00 02
1	1	0	0	0	0	00 03
0	0	1	0	0	0	00 04
1	0	1	0	0	0	00 05
0	1	1	0	0	0	00 06
1	1	1	0	0	0	00 07
0	0	0	1	0	0	00 08
1	0	0	1	0	0	00 09
0	1	0	1	0	0	00 0A
1	1	0	1	0	0	00 0b
0	0	1	1	0	0	00 0C
1	0	1	1	0	0	00 0d
0	1	1	1	0	0	00 0E
1	1	1	1	0	0	00 0F
0	0	0	0	1	0	00 10
1	0	0	0	1	0	00 11
0	1	0	0	1	0	00 12
1	1	0	0	1	0	00 13
0	0	1	0	1	0	00 14
1	0	1	0	1	0	00 15
0	1	1	0	1	0	00 16
1	1	1	0	1	0	00 17
0	0	0	1	1	0	00 18
1	0	0	1	1	0	00 19
0	1	0	1	1	0	00 1A
1	1	0	1	1	0	00 1B
0	0	1	1	1	0	00 1C
1	0	1	1	1	0	00 1D
0	1	1	1	1	0	00 1E
1	1	1	1	1	0	00 1F
0	0	0	0	0	1	00 20
1	0	0	0	0	1	00 21
0	1	0	0	0	1	00 22
1	1	0	0	0	1	00 23
0	0	1	0	0	1	00 24
1	0	1	0	0	1	00 25
0	1	1	0	0	1	00 26
1	1	1	0	0	1	00 27
0	0	0	1	0	1	00 28
1	0	0	1	0	1	00 29
0	1	0	1	0	1	00 2A
1	1	0	1	0	1	00 2B
0	0	1	1	0	1	00 2C
1	0	1	1	0	1	00 2D
0	1	1	1	0	1	00 2E
1	1	1	1	0	1	00 2F
0	0	0	0	1	1	00 30
1	0	0	0	1	1	00 31
0	1	0	0	1	1	00 32
1	1	0	0	1	1	00 33
0	0	1	0	1	1	00 34
1	0	1	0	1	1	00 35
0	1	1	0	1	1	00 36
1	1	1	0	1	1	00 37
0	0	0	1	1	1	00 38
1	0	0	1	1	1	00 39
0	1	0	1	1	1	00 3A
1	1	0	1	1	1	00 3B
0	0	1	1	1	1	00 3C
1	0	1	1	1	1	00 3D
0	1	1	1	1	1	00 3E
1	1	1	1	1	1	00 3F

0: Switch OFF 1: Switch ON

SW5				Data display
1	2	3	4	
0	0	0	0	00 00
1	0	0	0	00 01
0	1	0	0	00 02
1	1	0	0	00 03
0	0	1	0	00 04
1	0	1	0	00 05
0	1	1	0	00 06
1	1	1	0	00 07
0	0	0	1	00 08
1	0	0	1	00 09
0	1	0	1	00 0A
1	1	0	1	00 0b
0	0	1	1	00 0C
1	0	1	1	00 0d
0	1	1	1	00 0E
1	1	1	1	00 0F

0: Switch OFF 1: Switch ON

SW8			Data display
1	2	3	
0	0	0	00 00
1	0	0	00 01
0	1	0	00 02
1	1	0	00 03
0	0	1	00 04
1	0	1	00 05
0	1	1	00 06
1	1	1	00 07

0: Switch OFF 1: Switch ON

SW4, SW9, SW10		Data display
1	2	
0	0	00 00
1	0	00 01
0	1	00 02
1	1	00 03

[Indoor unit – Model setting information] (Request code: "162")

Data display

0	0	*	*
---	---	---	---

See the table on the right.

Display	Model setting state	Display	Model setting state
00		20	
01		21	
02		22	
03		23	
04	SVZ-KP·NA	24	
05		25	
06		26	
07		27	
08		28	
09		29	
0A		2A	
0b		2b	
0C		2C	
0d		2d	
0E		2E	
0F		2F	
10		30	PEA-A·AA
11		31	
12		32	
13		33	
14		34	
15		35	
16		36	
17		37	
18		38	
19		39	
1A		3A	
1b		3b	
1C		3C	
1d		3d	
1E		3E	
1F		3F	

[Indoor unit – Capacity setting information] (Request code: "163")

Data display

0	0	*	*
---	---	---	---

See the table on the right.

Display	Capacity setting state	Display	Capacity setting state
00		10	42
01		11	
02		12	
03		13	
04		14	
05		15	
06	12	16	
07		17	
08		18	
09	18	19	
0A		1A	
0b	24	1b	
0C		1C	
0d	30	1d	
0E		1E	
0F	36	1F	

[Wireless pair No. (indoor control board side) setting] (Request code: "165")

Data display

0	0	*	*
---	---	---	---

See the table on the right.

Display	Pair No. setting state
00	No. 0
01	No. 1 J41 disconnected
02	No. 2 J42 disconnected
03	No. 3 J41, J42 disconnected

SUZ-KA24NAHZ

—————> : Indicates the visible parts in the photos/figures.

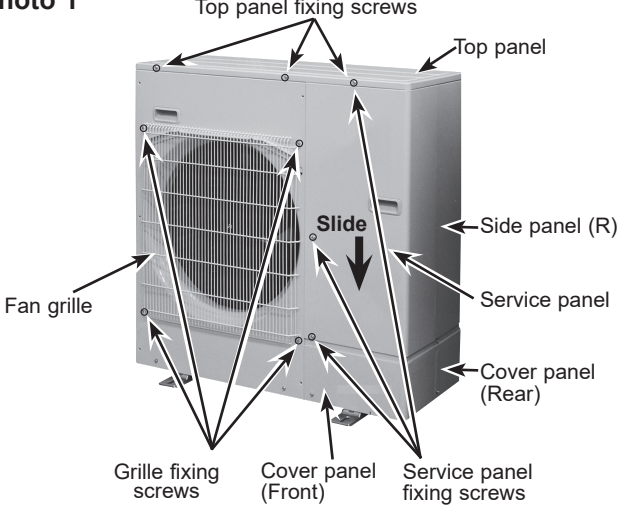
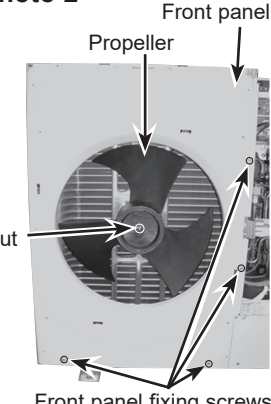
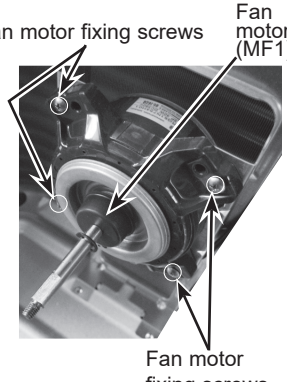
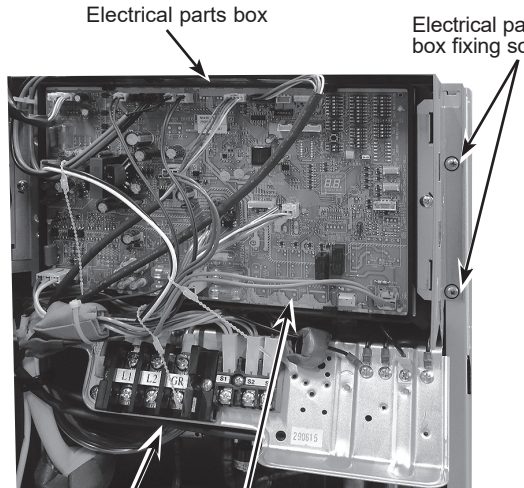
OPERATING PROCEDURE	PHOTOS/FIGURES
<p>1. Removing the service panel and top panel</p> <p>(1) Remove 3 service panel fixing screws (5 × 12) and slide the hook on the right downward to remove the service panel.</p> <p>(2) Remove screws (3 for front, 3 for rear/5 × 12) of the top panel and remove it.</p>	<p>Photo 1</p>  <p>Labels in Photo 1: Top panel fixing screws, Top panel, Side panel (R), Service panel, Cover panel (Rear), Fan grille, Grille fixing screws, Cover panel (Front), Service panel fixing screws. An arrow labeled 'Slide' points to the service panel hook.</p>
<p>2. Removing the fan motor (MF1)</p> <p>(1) Remove the service panel. (See Photo 1)</p> <p>(2) Remove the top panel. (See Photo 1)</p> <p>(3) Remove 4 fan grille fixing screws (5 × 12) to detach the fan grille. (See Photo 1)</p> <p>(4) Remove a nut (for right handed screw of M6) to detach the propeller. (See Photo 2)</p> <p>(5) Disconnect the connector CNF1 on controller circuit board in electrical parts box.</p> <p>(6) Remove 4 fan motor fixing screws (5 × 20) to detach the fan motor. (See Photo 3)</p>	<p>Photo 2</p>  <p>Labels in Photo 2: Front panel, Propeller, Nut, Front panel fixing screws.</p> <p>Photo 3</p>  <p>Labels in Photo 3: Fan motor fixing screws, Fan motor (MF1), Fan motor fixing screws.</p>
<p>3. Removing the electrical parts box</p> <p>(1) Remove the service panel. (See Photo 1)</p> <p>(2) Remove the top panel. (See Photo 1)</p> <p>(3) Disconnect the indoor/outdoor connecting wire from terminal block.</p> <p>(4) Disconnect the connector CNF1, SV2, LEV-A and LEV-B on the controller circuit board.</p> <p><Symbols on the board></p> <ul style="list-style-type: none"> • CNF1: Fan motor • LEV-A, LEV-B: LEV • SV2: Base Heater <p>(5) Disconnect the pipe-side connections of the following parts.</p> <ul style="list-style-type: none"> • Thermistor <Liquid> (TH3) • Thermistor <Discharge> (TH4) • Thermistor <2-phase pipe, Ambient> (TH7/6) • High pressure switch (63H) • 4-way valve coil (21S4) • Thermistor <Comp. surface> (TH33) <p>(6) Remove the terminal cover and disconnect the compressor lead wire.</p> <p>(7) Remove an electrical parts box fixing screw (4 × 10) and detach the electrical parts box by pulling it upward. The electrical parts box is fixed with 2 hooks on the left and 1 hook on the right.</p>	<p>Photo 4</p>  <p>Labels in Photo 4: Electrical parts box, Electrical parts box fixing screws, Terminal block (TB1), Controller circuit board (C.B.).</p>

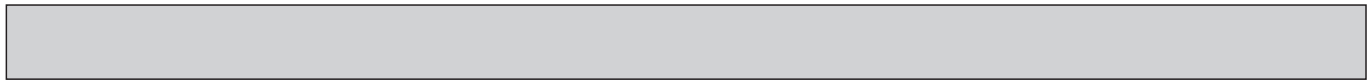

OPERATING PROCEDURE

4. Removing the thermistor <Liquid> (TH3) and thermistor <2-phase pipe> (TH6)

- (1) Remove the service panel. (See Photo 1)
- (2) Remove the top panel. (See Photo 1)
- (3) Disconnect the connector TH7/6 (red) and TH3 (white) on the controller circuit board in the electrical parts box.
- (4) Loosen the 2 clamps for the lead wires on the top of the electrical parts box.
- (5) Pull out the thermistor <2-phase pipe> (TH6) and the thermistor <Liquid> (TH3) from each sensor holders.

Note: When replacing thermistor <2-phase pipe> (TH6), replace it together with thermistor <Ambient> (TH7), since they are combined together. Refer to procedure No.5 below to remove thermistor <Ambient>.

PHOTOS/FIGURES

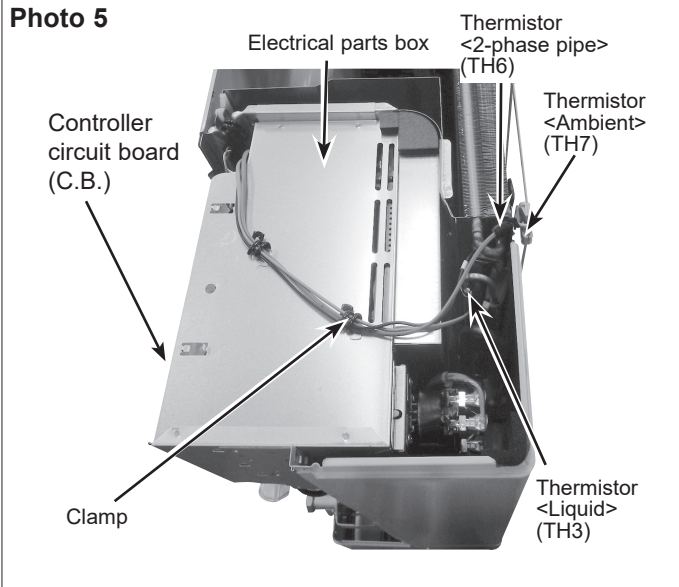

5. Removing the thermistor <Ambient> (TH7)

- (1) Remove the service panel. (See Photo 1)
- (2) Remove the top panel. (See Photo 1)
- (3) Disconnect the connector TH7/6 (red) on the controller circuit board in the electrical parts box.
- (4) Loosen the clamp for the lead wire in the rear of the electrical parts box. (See Photo 5)
- (5) Pull out the thermistor <Ambient> (TH7) from the sensor holder.

Note: When replacing thermistor <Ambient> (TH7), replace it together with thermistor <2-phase pipe> (TH6), since they are combined together. Refer to procedure No.4 above to remove thermistor <2-phase pipe>.

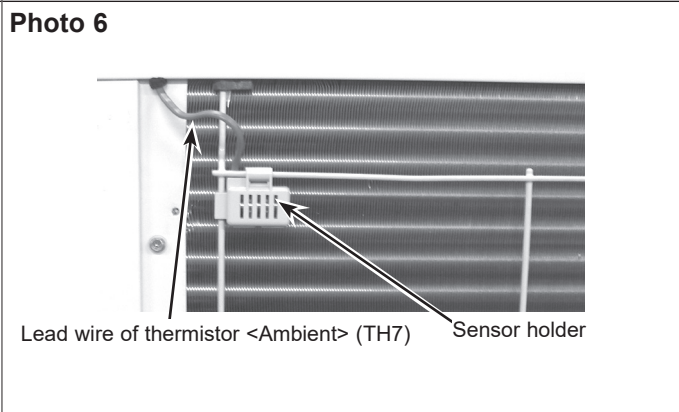

6. Removing the thermistor <Discharge> (TH4) and thermistor <Comp. surface> (TH33)

- (1) Remove the service panel. (See Photo 1)
- (2) Disconnect the connectors, TH4 (white) and TH33 (yellow), on the controller circuit board in the electrical parts box.
- (3) Loosen the clamp for the lead wire in the rear of the electrical parts box. (See Photo 5)
- (4) Pull out the thermistor <Discharge> (TH4) from the sensor holder.

[Removing the thermistor<Comp. surface> (TH33)]

- (5) Remove the compressor cover (upper) and pull out the thermistor <Comp. surface> (TH33) from the holder of the compressor shell.

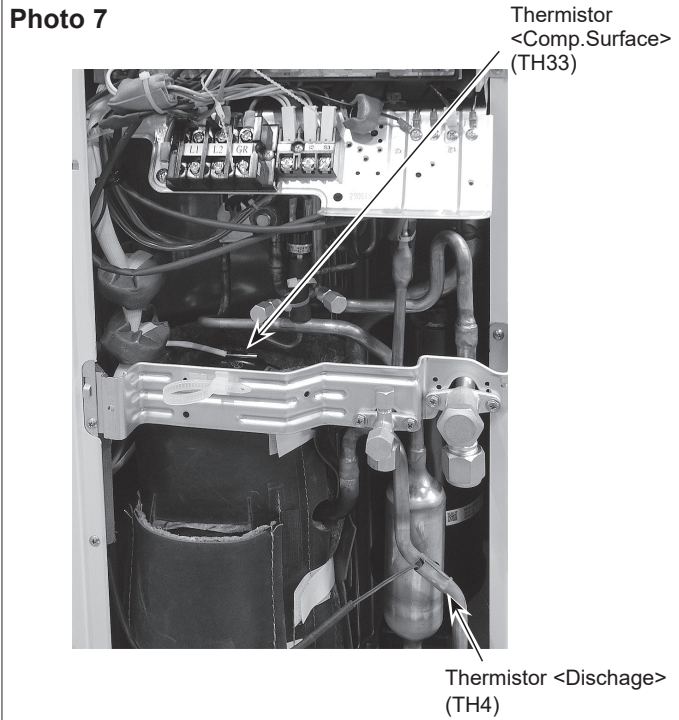

OPERATING PROCEDURE

7. Removing the 4-way valve coil (21S4), LEV coil (LEV(A), LEV(B))

- (1) Remove the service panel. (See Photo 1)
- (2) Remove the top panel. (See Photo 1)
- (3) Remove the electrical parts box. (See Photo 4)
- [Removing the 4-way valve coil]**
- (4) Remove 4-way valve coil fixing screw (M4 × 6).
- (5) Remove the 4-way valve coil by sliding the coil toward you.
- (6) Disconnect the connector 21S4 (green) on the controller board in the electrical parts box.

[Removing the LEV coil]

- (4) Remove the LEV coil by sliding the coil upward.
- (5) Disconnect the connectors, LEV A (white) and LEV B (red), on the controller circuit board in the electrical parts box.

8. Removing the 4-way valve

- (1) Remove the service panel. (See Photo 1)
- (2) Remove the top panel. (See Photo 1)
- (3) Remove the electrical parts box. (See Photo 4)
- (4) Remove 3 valve bed fixing screws (4 × 10) and 4 ball valve and stop valve fixing screws (5 × 16) and then remove the valve bed.
- (5) Remove 3 right side panel fixing screws (5 × 12) in the rear of the unit and then remove the right side panel.
- (6) Remove the 4-way valve coil. (See Photo 8)
- (7) Recover refrigerant.
- (8) Remove the welded part of 4-way valve.

Note 1: Recover refrigerant without spreading it in the air.

Note 2: The welded part can be removed easily by removing the right side panel.

Note 3: When installing the 4-way valve, cover it with a wet cloth to prevent it from heating (120°C or more), then braze the pipes so that the inside of pipes are not oxidized.

9. Removing the LEV

- (1) Remove the service panel. (See Photo 1)
- (2) Remove the top panel. (See Photo 1)
- (3) Remove the electrical parts box. (See Photo 4)
- (4) Remove 3 valve bed fixing screws (4 × 10) and 4 ball valve and stop valve fixing screws (5 × 16) and then remove the valve bed.
- (5) Remove 3 right side panel fixing screws (5 × 12) in the rear of the unit and then remove the right side panel.
- (6) Remove the LEV.
- (7) Recover refrigerant.
- (8) Remove the welded part of linear expansion valve.

Note 1: Recover refrigerant without spreading it in the air.

Note 2: The welded part can be removed easily by removing the right side panel.

Note 3: When installing the LEV, cover it with a wet cloth to prevent it from heating (120°C or more), then braze the pipes so that the inside of pipes are not oxidized.

PHOTOS/FIGURES

Photo 8

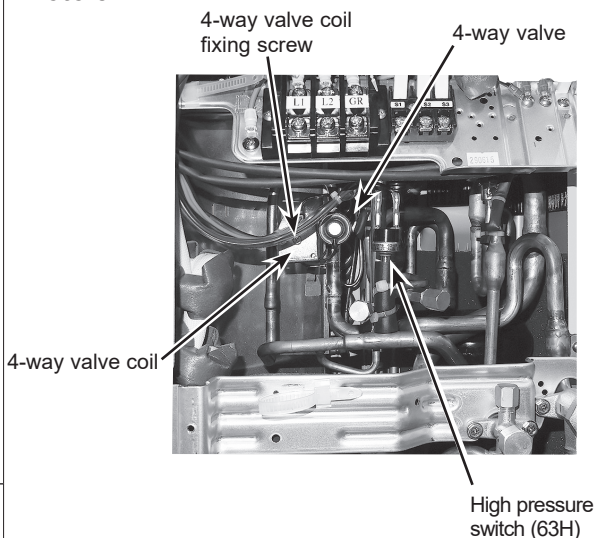
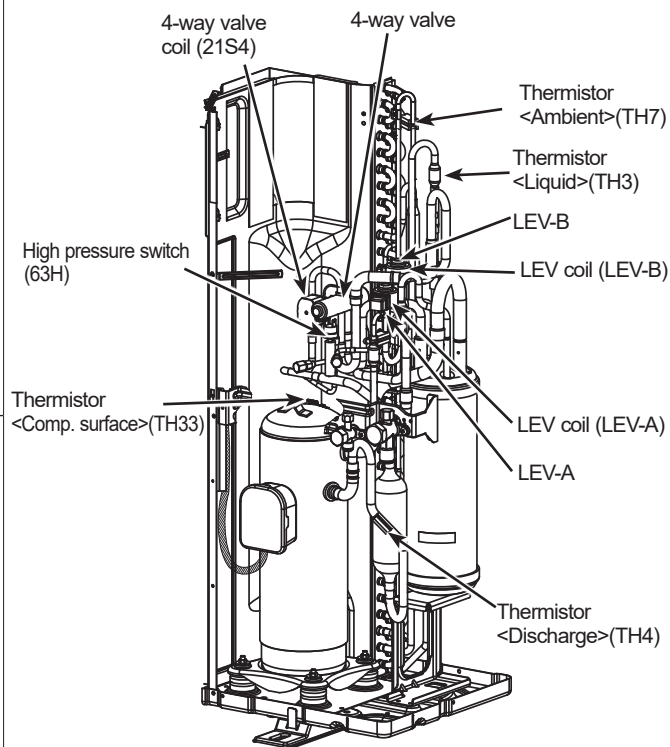

Figure 1



OPERATING PROCEDURE

10. Removing the high pressure switch (63H)

- (1) Remove the service panel. (See Photo 1)
- (2) Remove the top panel. (See Photo 1)
- (3) Remove the electrical parts box. (See Photo 4)
- (4) Remove 3 right side panel fixing screws (5 × 12) in the rear of the unit and remove the right side panel.
- (5) Pull out the lead wire of high pressure switch.
- (6) Recover refrigerant.
- (7) Remove the welded part of high pressure switch.

Note 1: Recover refrigerant without spreading it in the air.

Note 2: The welded part can be removed easily by removing the right side panel.

Note 3: When installing the high pressure switch, cover it with a wet cloth to prevent it from heating (100°C or more), then braze the pipes so that the inside of pipes are not oxidized.

PHOTOS/FIGURES

Photo 9

Lead wire of high pressure switch

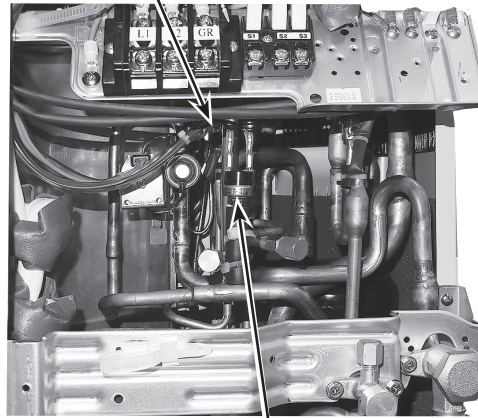

High pressure switch (63H)

11. Removing the reactor (DCL)

- (1) Remove the service panel. (See Photo 1)
- (2) Remove the top panel. (See Photo 1)
- (3) Remove the electrical parts box. (See Photo 4)
- (4) Remove the reactor fixing screws (4 places, 4 × 10)

Note: The reactor is attached to the rear of the electrical parts box.

Photo10

Reactor fixing screws

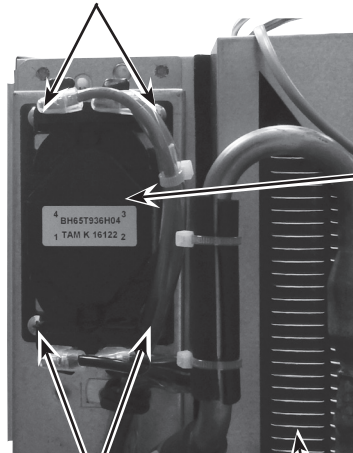

Reactor (DCL)

Reactor fixing screws

Electrical parts box

OPERATING PROCEDURE

12. Removing the compressor (MC)

- (1) Remove the service panel. (See Photo 1)
- (2) Remove the top panel. (See Photo 1)
- (3) Remove 2 front cover panel fixing screws (5 × 12) and remove the front cover panel. (See Photo 1)
- (4) Remove 2 back cover panel fixing screws (5 × 12) and remove the back cover panel.
- (5) Remove the electrical parts box. (See Photo 4)
- (6) Remove 3 valve bed fixing screws (4 × 10) and 4 ball valve and stop valve fixing screws (5 × 16) and then remove the valve bed.
- (7) Remove 3 right side panel fixing screws (5 × 12) in the rear of the unit then remove the right side panel.
- (8) Remove 2 separator fixing screws (4 × 10) and remove the separator.
- (9) Recover refrigerant.
- (10) Remove the 3 points of the compressor fixing nut using a spanner or an adjustable wrench.
- (11) Remove the welded pipe of compressor inlet and outlet then remove the compressor.

Note: Recover refrigerant without spreading it in the air.

PHOTOS/FIGURES

Photo 11

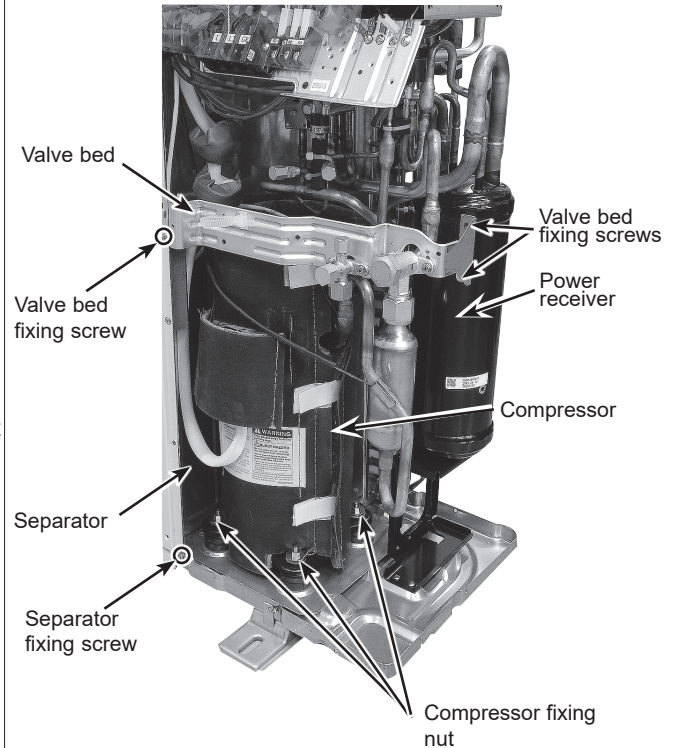

13. Removing the power receiver

- (1) Remove the service panel. (See Photo 1)
- (2) Remove the top panel. (See Photo 1)
- (3) Remove 2 front cover panel fixing screws (5 × 12) and remove the front cover panel. (See Photo 1)
- (4) Remove 2 back cover panel fixing screws (5 × 12) and remove the back cover panel.
- (5) Remove the electrical parts box. (See Photo 4)
- (6) Remove 3 valve bed fixing screws (4 × 10) and 4 ball valve and stop valve fixing screws (5 × 16) then remove the valve bed.
- (7) Remove 3 right side panel fixing screws (5 × 12) in the rear of the unit then remove the right side panel.
- (8) Recover refrigerant.
- (9) Remove 4 welded pipes of power receiver inlet and outlet.
- (10) Remove 2 receiver leg fixing screws (4 × 10).

Note: Recover refrigerant without spreading it in the air.

Photo 12

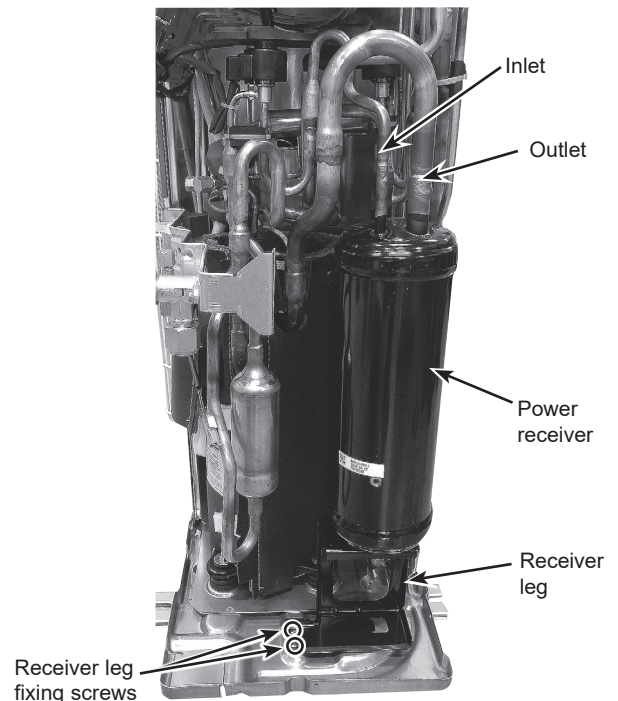

OPERATING PROCEDURE

14. Removing the base heater

- (1) Remove the service panel. (See Photo 1)
- (2) Remove the top panel. (See Photo 1)
- (3) Remove the upper 2 screws (5 × 12) fixing the motor support, the lower 2 screws (5 × 12) fixing the base and the screw (4 × 10) fixing the separator to detach the front panel. (See Photo 1)
- (4) Remove a nut (for right handed screw of M6) to detach the propeller. (See Photo 2)
- (5) Remove all of the following connectors from controller circuit board;
<Diagram symbol in the connector housing>
 - Fan motor (CNF1)
 - Base heater (SV2)Pull out the disconnected wire from the electrical parts box. (See Photo 4)
- (6) Loosen the clamps on the side of the motor support and on the upper side of the separator.
- (7) Remove 2 motor support fixing screws (4 x 10), then remove the motor support with fan motor still attached. (See Photo 13)
- (8) Remove 4 base heater support fixing screws (4 x 10), then remove the base heater support.
- (9) Remove the base heater. (See Photo 14)

Notes:

1. Tighten the propeller fan with a torque of 5.7 ± 0.3 N·m [4.2 ± 0.2 ft = lbs]
2. Rotate the propeller fan and make sure that the base heater and the lead wires do not interfere with the movement of the propeller fan.

PHOTOS/FIGURES

Photo 13

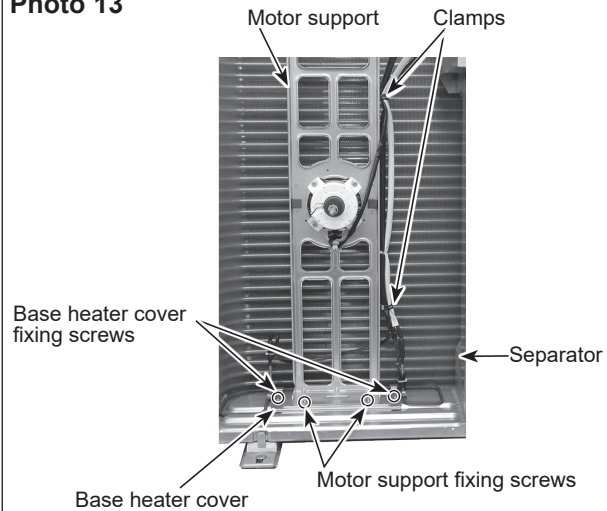
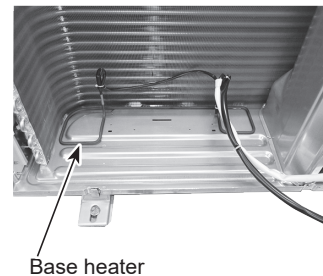
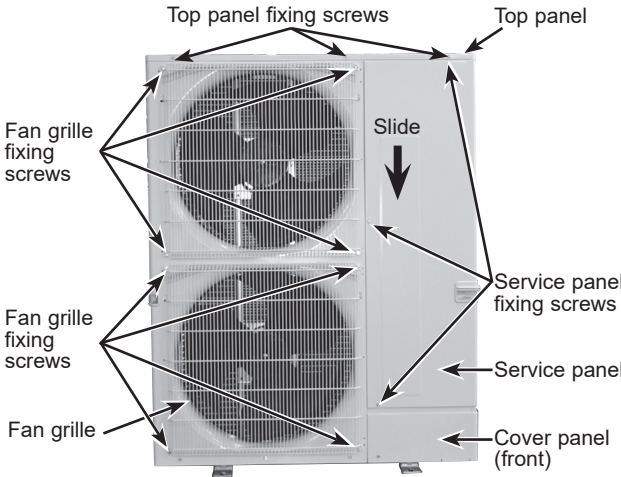
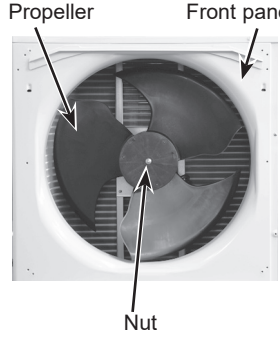
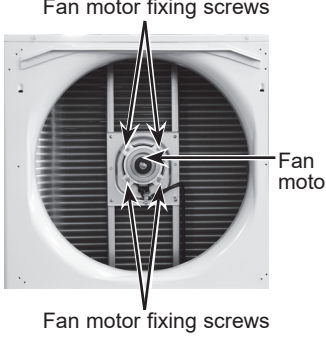

Photo 14



SUZ-KA30NAHZ SUZ-KA36NAHZ

————> : Indicates the visible parts in the photos/figures.
 - - - - -> : Indicates the invisible parts in the photos/figures.

OPERATING PROCEDURE	PHOTOS/FIGURES
<p>1. Removing the service panel and top panel</p> <p>(1) Remove 3 service panel fixing screws (5 × 12) and slide the hook on the right downward to remove the service panel.</p> <p>(2) Remove screws (3 for front, 3 for rear/5 × 12) of the top panel and remove it.</p>	<p>Photo 1</p> 
<p>2. Removing the fan motor (MF1, MF2)</p> <p>(1) Remove the service panel. (See Photo 1)</p> <p>(2) Remove the top panel. (See Photo 1)</p> <p>(3) Remove 4 fan grille fixing screws (5 × 12) to detach the fan grille. (See Photo 1)</p> <p>(4) Remove a nut (for right handed screw of M6) to detach the propeller. (See Photo 2)</p> <p>(5) Disconnect the connectors, CNF1, CNF2 on controller circuit board in electrical parts box.</p> <p>(6) Remove 4 fan motor fixing screws (5 × 20) to detach the fan motor. (See Photo 3)</p>	<p>Photo 2 Photo 3</p>  

OPERATING PROCEDURE

3. Removing the electrical parts box

- (1) Remove the service panel. (See Photo 1)
- (2) Remove the top panel. (See Photo 1)
- (3) Disconnect the indoor/outdoor connecting wire and the power supply wire from terminal block.
- (4) Disconnect the connector CNF1, CNF2, SV2, LEV-A, LEV-B and LEV-C on the controller circuit board.
<Symbols on the board>
 - CNF1, CNF2: Fan motor
 - LEV-A, LEV-B, LEV-C: LEV
 - SV2: Base Heater
- (5) Disconnect the pipe-side connections of the following parts.
 - Thermistor <Liquid>(TH3)
 - Thermistor <Discharge>(TH4)
 - Thermistor <2-phase pipe>(TH6)
 - Thermistor <Ambient>(TH7)
 - Thermistor <Suction> (TH32)
 - Thermistor <Comp. surface> (TH33)
 - High pressure switch (63H)
 - 4-way valve coil (21S4)
- (6) Remove the terminal cover and disconnect the compressor lead wire.
- (7) Loosen the clamp for lead wires on the separator.
- (8) Remove 2 electrical parts box fixing screws (4 × 10) and detach the electrical parts box by pulling it upward.
The electrical parts box is fixed with 2 hooks on the left and 1 hook on the right.

PHOTOS/FIGURES

Photo 4

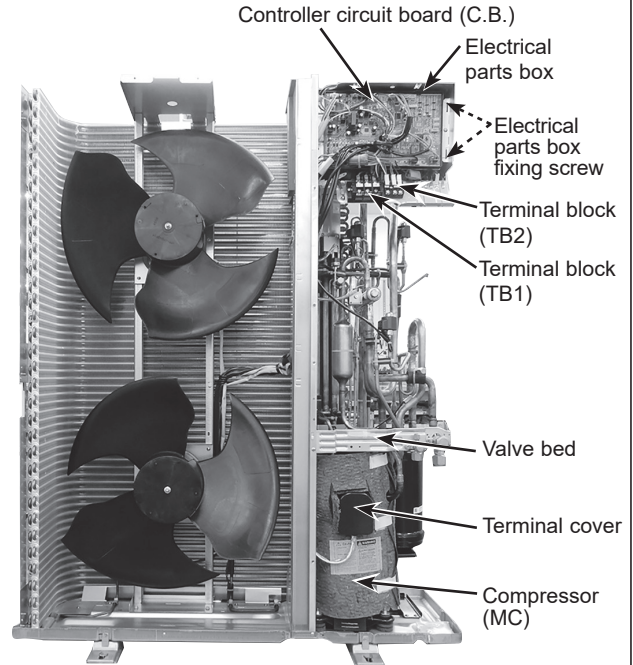

OPERATING PROCEDURE

4. Removing the thermistor <2-phase pipe> (TH6) and thermistor <Ambient>(TH7)

- (1) Remove the service panel. (See Photo 1)
- (2) Remove the top panel. (See Photo 1)
- (3) Disconnect the connectors TH7/6 (red) on the controller circuit board in the electrical parts box.
Loosen fasteners for lead wires in the electrical parts box.
- (4) Loosen the clamp for lead wires in the rear of the electrical parts box.
- (5) Pull out the thermistor <2-phase pipe> (TH6) and thermistor <Ambient> (TH7) from the sensor holder.

Note: When replacing thermistor <2-phase pipe> (TH6) or thermistor <Ambient> (TH7), replace it together.

PHOTOS/FIGURES

Photo 5

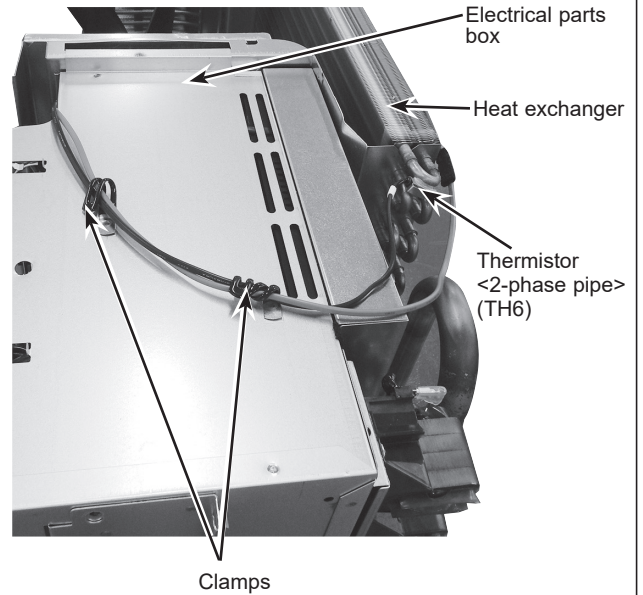
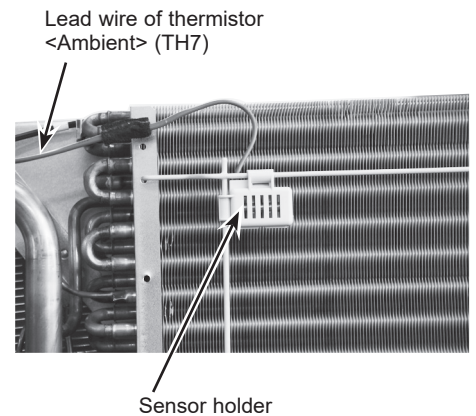

Photo 6



OPERATING PROCEDURE

5. Removing the thermistor <Discharge> (TH4)

- (1) Remove the service panel. (See Photo 1)
- (2) Disconnect the connector TH4 (white) on the controller circuit board in the electrical parts box.
Loosen fasteners for lead wires in the electrical parts box.
- (3) Loosen clamps for the lead wire on the separator (See Photo 7).
- (4) Pull out the thermistor <Discharge> (TH4) from the sensor holder.

PHOTOS/FIGURES

Photo 7

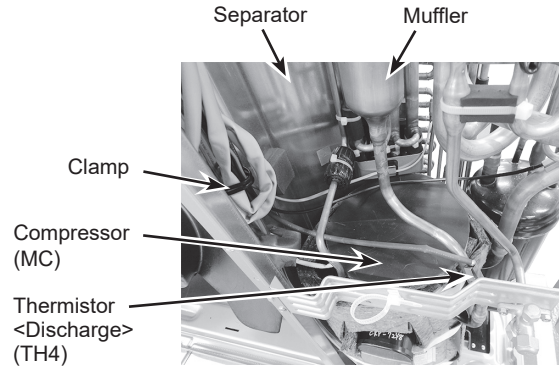

6. Removing the thermistor <Liquid> (TH3), thermistor <Suction> (TH32), thermistor <Comp. surface> (TH33)

- (1) Remove the service panel. (See Photo 1)
- (2) Disconnect the connectors, TH3 (white) and TH32 (black), TH33 (red) on the controller circuit board in the electrical parts box.
Loosen fasteners for lead wires in the electrical parts box.
- (3) Loosen clamps for the lead wires on the separator (See Photo 7).
Loosen clamp and cable strap for lead wires on the bottom of the electrical parts box. (Note that this procedure is only for removing TH32.)
- (4) Loosen clamp for the lead wire for TH3 and TH32.
- (5) Pull out the thermistor <Liquid> (TH3), thermistor <Suction> (TH32), thermistor <Comp. surface> (TH33).

Photo 8

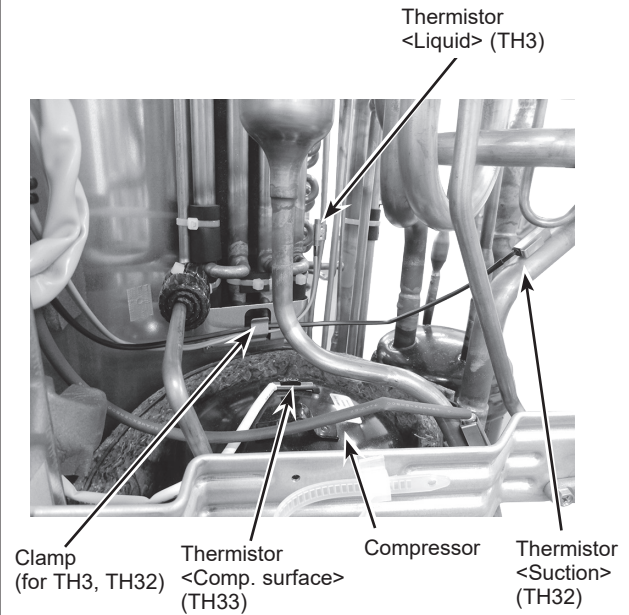

OPERATING PROCEDURE

7. Removing the 4-way valve coil (21S4), and linear expansion valve coil (LEV-A, LEV-B, LEV-C)

- (1) Remove the service panel. (See Photo 1)
- (2) Remove the top panel. (See Photo 1)
- (3) Remove the electrical parts box. (See Photo 4)

[Removing the 4-way valve coil]

- (4) Remove 4-way valve coil fixing screw (M5 × 7).
- (5) Remove the 4-way valve coil by sliding the coil toward you. Loosen the clamp for lead wires on the separator. Loosen fasteners and the cable strap for lead wires in the electrical parts box.
- (6) Disconnect the connector 21S4 (green) on the controller circuit board in the electrical parts box.

[Removing the linear expansion valve coil]

- (4) Loosen a fastener for lead wires.
- (5) Remove the linear expansion valve coil by sliding the coil upward. Loosen the clamp for lead wires on the separator. Loosen a fastener for lead wires in the electrical parts box.
- (6) Disconnect the connectors, LEV-A (white), LEV-B (red) and LEV-C (blue) on the controller circuit board in the electrical parts box.

8. Removing the 4-way valve

- (1) Remove the service panel. (See Photo 1)
- (2) Remove the top panel. (See Photo 1)
- (3) Remove the electrical parts box. (See Photo 4)
- (4) Remove 2 cover panel front fixing screws (5 × 12) and remove the cover panel front. (See Photo 1)
- (5) Remove 2 cover panel rear fixing screws (5 × 12) and remove the cover panel rear.
- (6) Remove 3 valve bed fixing screws (4 × 10) and 4 ball valve and stop valve fixing screws (5 × 16) then remove the valve bed.
- (7) Remove 3 side panel (R) fixing screws (5 × 12) in the rear of the unit then remove the side panel (R).
- (8) Remove the 4-way valve coil.
- (9) Recover refrigerant.
- (10) Remove the welded part of 4-way valve.

Note :When installing the 4-way valve, cover it with a wet cloth to prevent it from heating (250°F [120°C] or more), then braze the pipes so that the inside of pipes are not oxidized.

9. Removing linear expansion valve

- (1) Remove the service panel. (See Photo 1)
- (2) Remove the top panel. (See Photo 1)
- (3) Remove the electrical parts box. (See Photo 4)
- (4) Remove the cover panel front. (Refer to procedure 8)
- (5) Remove the cover panel rear. (Refer to procedure 8)
- (6) Remove the valve bed. (Refer to procedure 8)
- (7) Remove the side panel (R). (Refer to procedure 8)
- (8) Remove the linear expansion valve coil.
- (9) Recover refrigerant.
- (10) Remove the welded part of linear expansion valve.

Note : When installing the linear expansion valve, cover it with a wet cloth to prevent it from heating (250°F [120°C] or more), then braze the pipes so that the inside of pipes are not oxidized.

PHOTOS/FIGURES

Photo 9

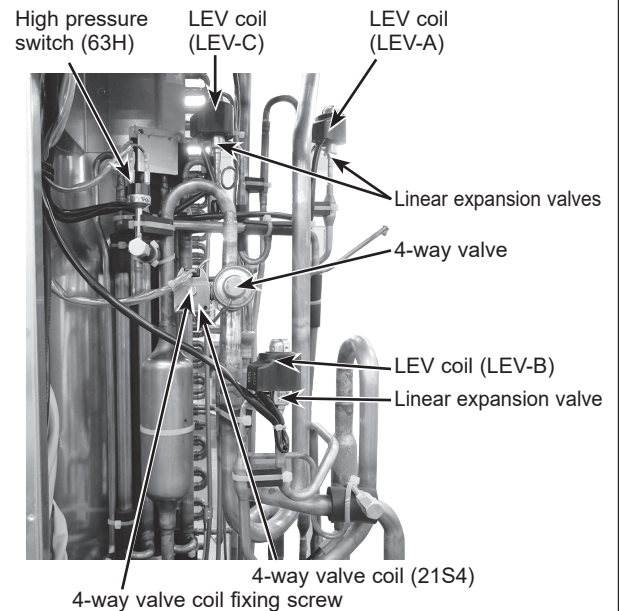

10. Removing the high pressure switch (63H)

- (1) Remove the service panel. (See Photo 1)
- (2) Remove the top panel. (See Photo 1)
- (3) Remove the electrical parts box. (See Photo 4)
- (4) Remove the cover panel front.
- (5) Remove the cover panel rear.
- (6) Remove the valve bed. (Refer to procedure 8)
- (7) Remove the side panel (R). (Refer to procedure 8)
- (8) Pull out the lead wire of high pressure switch (63H).
- (9) Recover refrigerant.
- (10) Remove the welded part of high pressure switch (63H).

Note : When installing the high pressure switch, cover it with a wet cloth to prevent it from heating (210°F [100°C] or more), then braze the pipes so that the inside of pipes are not oxidized.

OPERATING PROCEDURE

11. Removing the reactor (DCL)

- (1) Remove the service panel. (See Photo 1)
- (2) Remove the top panel. (See Photo 1)
- (3) Remove the electrical parts box. (See Photo 4)
- (4) Remove 6 reactor fixing screws (4 × 10) and remove the reactors.

Note 1: The reactor and capacitor is attached to the rear of the electrical parts box.

Note 2: The 3 pieces of reactors to be replaced must have the same color of sticker. (Green, Orange, or Blue)

PHOTOS/FIGURES

Photo 10

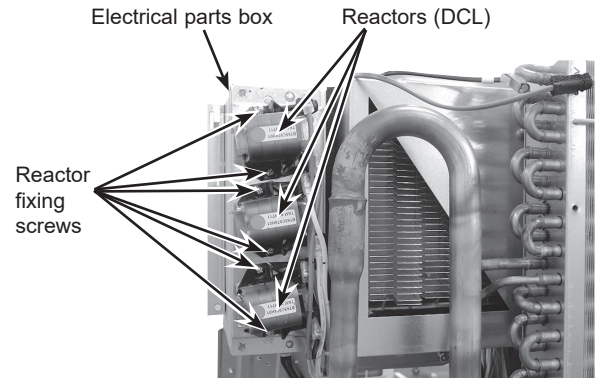

12. Removing the compressor (MC)

- (1) Remove the service panel. (See Photo 1)
- (2) Remove the top panel. (See Photo 1)
- (3) Remove the electrical parts box. (See Photo 4)
- (4) Remove the cover panel front. (Refer to procedure 8)
- (5) Remove the cover panel rear. (Refer to procedure 8)
- (6) Remove the valve bed. (Refer to procedure 8)
- (7) Remove the side panel (R). (Refer to procedure 8)
- (8) Remove 3 separator fixing screws (4 × 10) and remove the separator.
- (9) Remove the comp felt for compressor.
- (10) Recover refrigerant.
- (11) Remove the welded pipe of compressor inlet and outlet then remove the compressor.
- (12) Remove the 3 points of the compressor fixing nut using a spanner or a adjustable wrench.

Note: Recover refrigerant without spreading it in the air.

13. Removing the power receiver

- (1) Remove the service panel. (See Photo 1)
- (2) Remove the top panel. (See Photo 1)
- (3) Remove the electrical parts box. (See Photo 4)
- (4) Remove the cover panel front. (Refer to procedure 8)
- (5) Remove the cover panel rear. (Refer to procedure 8)
- (6) Remove the valve bed. (Refer to procedure 8)
- (7) Remove the side panel (R). (Refer to procedure 8)
- (8) Recover refrigerant.
- (9) Remove 4 welded pipes of power receiver inlet and outlet.
- (10) Remove 2 receiver leg fixing screws (4 × 10).

Note: Recover refrigerant without spreading it in the air.

Photo 11

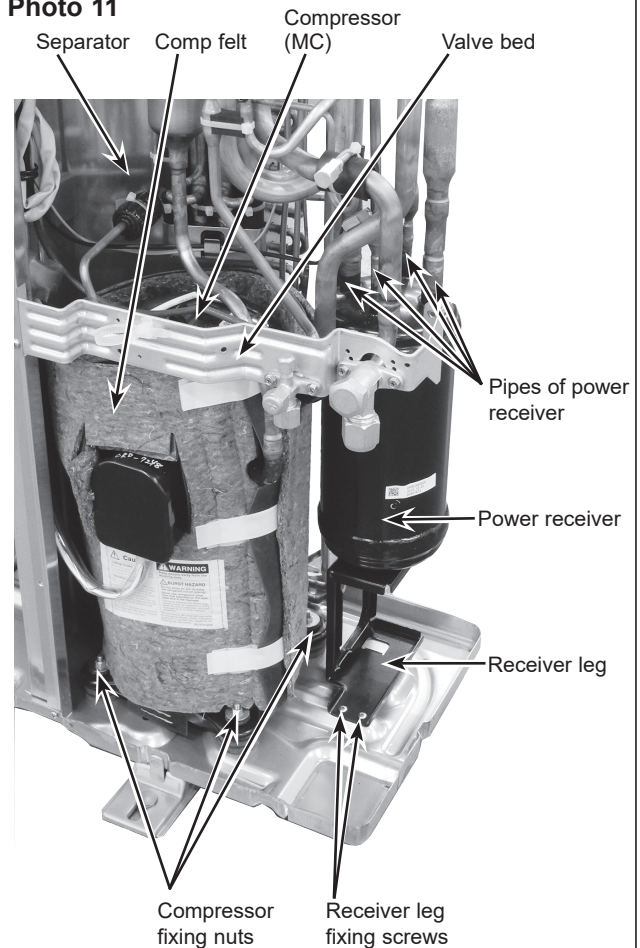

15-1. REMOTE CONTROLLER FUNCTIONS

<PAR-40MAA>

Controller interface

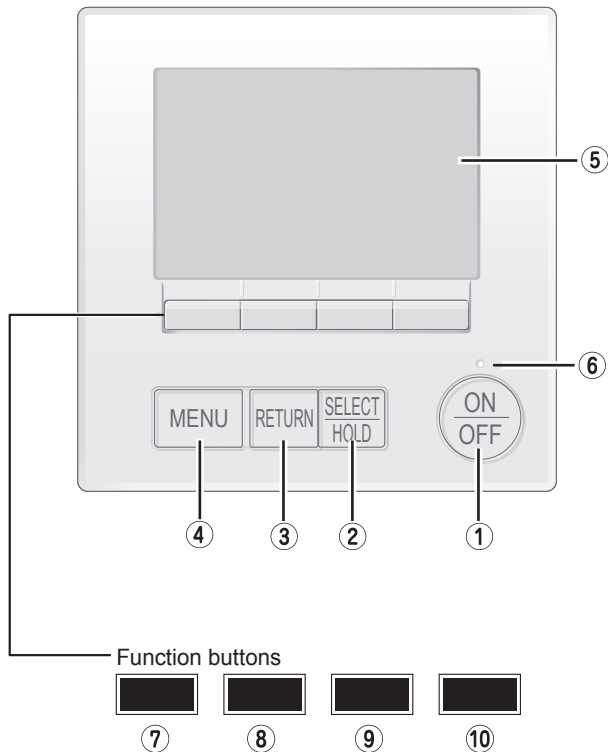

The functions of the function buttons change depending on the screen.

Refer to the button function guide that appears at the bottom of the LCD for the functions they serve on a given screen.

When the system is centrally controlled, the button function guide that corresponds to the locked button will not appear.

Main display

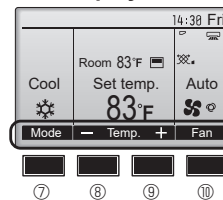

Main menu

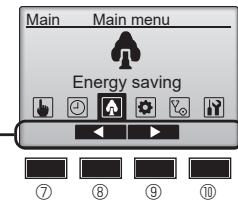

Menu screen

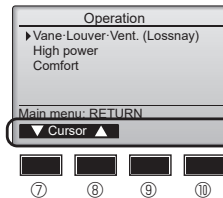

Function guide

① [ON/OFF] button

Press to turn ON/OFF the indoor unit.

② [SELECT/HOLD] button

Press to save the setting.

When the Main menu is displayed, pressing this button will enable/disable the HOLD function.

③ [RETURN] button

Press to return to the previous screen.

④ [MENU] button

Press to bring up the Main menu.

⑤ Backlit LCD

Operation settings will appear.

When the backlight is off, pressing any button turns the backlight on and it will stay lit for a certain period of time depending on the screen.

When the backlight is off, pressing any button turns the backlight on and does not perform its function. (except for the [ON/OFF] button)

⑥ ON/OFF lamp

This lamp lights up in green while the unit is in operation. It blinks while the remote controller is starting up or when there is an error.

⑦ Function button [F1]

Main display: Press to change the operation mode.

Menu screen: The button function varies with the screen.

⑧ Function button [F2]

Main display: Press to decrease temperature.

Main menu: Press to move the cursor left.

Menu screen: The button function varies with the screen.

⑨ Function button [F3]

Main display: Press to increase temperature.

Main menu: Press to move the cursor right.

Menu screen: The button function varies with the screen.

⑩ Function button [F4]

Main display: Press to change the fan speed.

Menu screen: The button function varies with the screen.

Display

The main display can be displayed in two different modes: "Full" and "Basic". The initial setting is "Full". To switch to the "Basic" mode, change the setting on the Main display setting. (Refer to operation manual included with remote controller.)

<Full mode>

All icons are displayed for explanation.

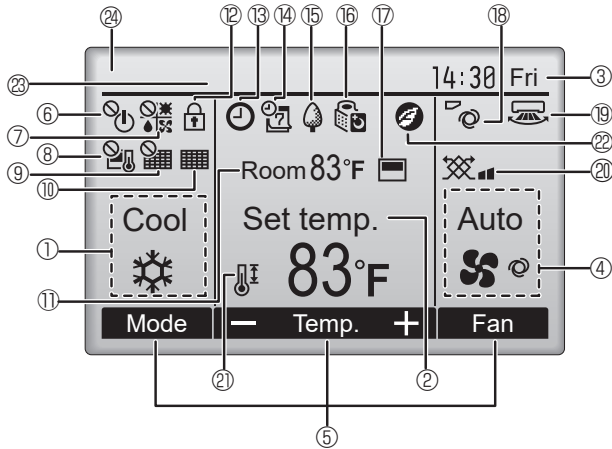

<Basic mode>

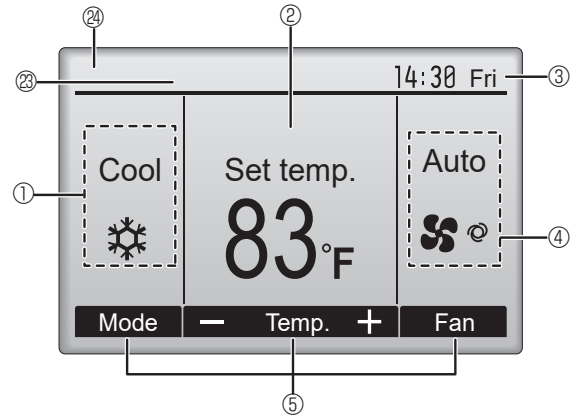

① Operation mode

② Preset temperature

③ Clock

④ Fan speed

⑤ Button function guide

Functions of the corresponding buttons appear here.



Appears when the ON/OFF operation is centrally controlled.



Appears when the operation mode is centrally controlled.



Appears when the preset temperature is centrally controlled.



Appears when the filter reset function is centrally controlled.



Indicates when filter needs maintenance.

⑪ Room temperature



Appears when the buttons are locked.



Appears when the On/Off timer or Auto-off timer function is enabled.

appears when the timer is disabled by the centralized control system.
 appears when the HOLD function is enable.



Appears when the Weekly timer is enabled.



Appears while the units are operated in the energy saving mode. (Will not appear on some models of indoor units)



Appears while the outdoor units are operated in the silent mode.



Appears when the built-in thermistor on the remote controller is activated to monitor the room temperature (⑪).

appears when the thermistor on the indoor unit is activated to monitor the room temperature.



Indicates the vane setting.



Indicates the louver setting.



Indicates the ventilation setting.



Appears when the preset temperature range is restricted.



Appears when an energy saving operation is performed using a "3D i-See sensor" function.

⑳ Centrally controlled

Appears for a certain period of time when a centrally-controlled item is operated.

㉑ Preliminary error display

An check code appears during the preliminary error.

Most settings (except ON/OFF, mode, fan speed, temperature) can be made from the Main menu.

Menu structure

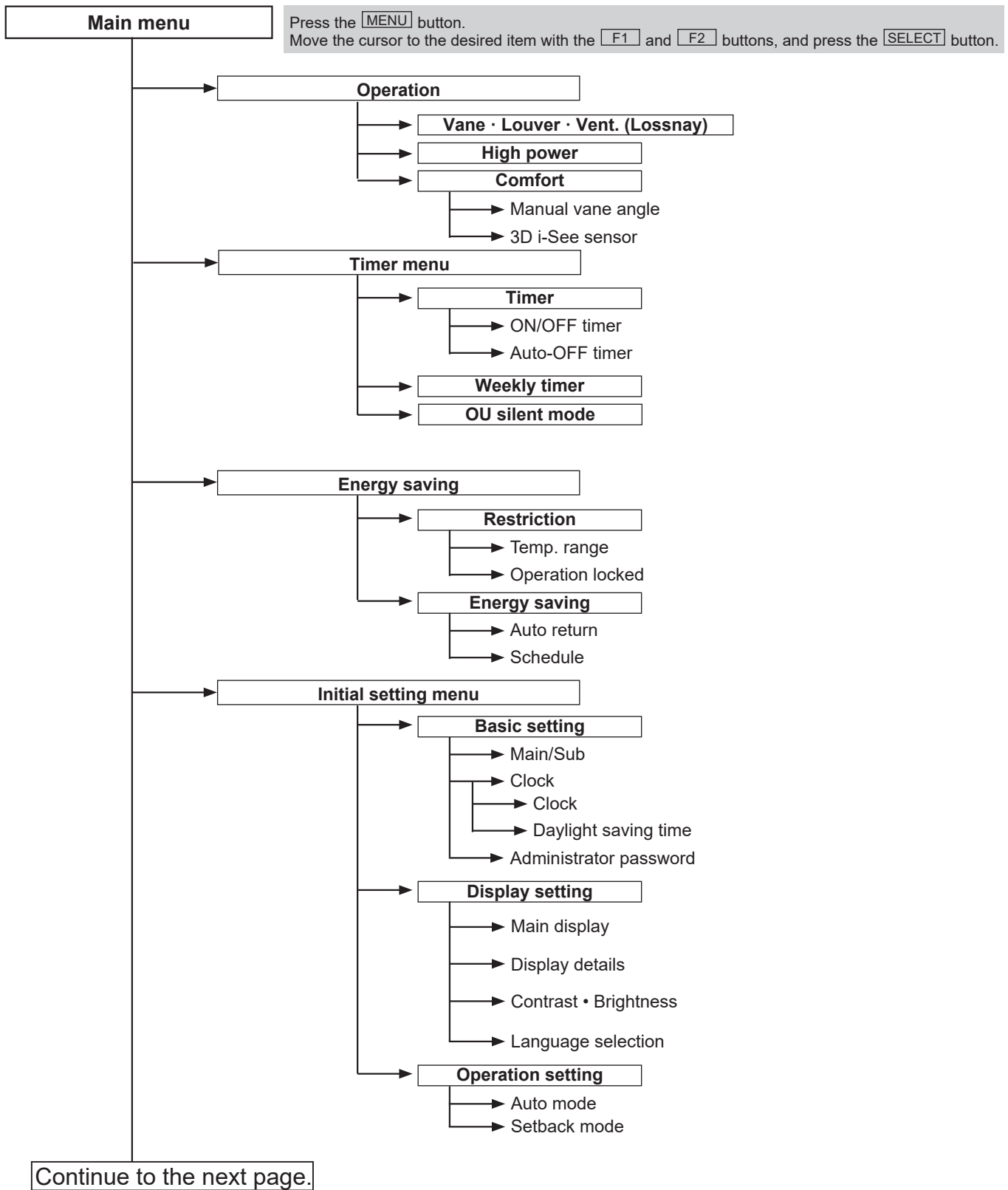

Not all functions are available on all models of indoor units.

Continue from the previous page.

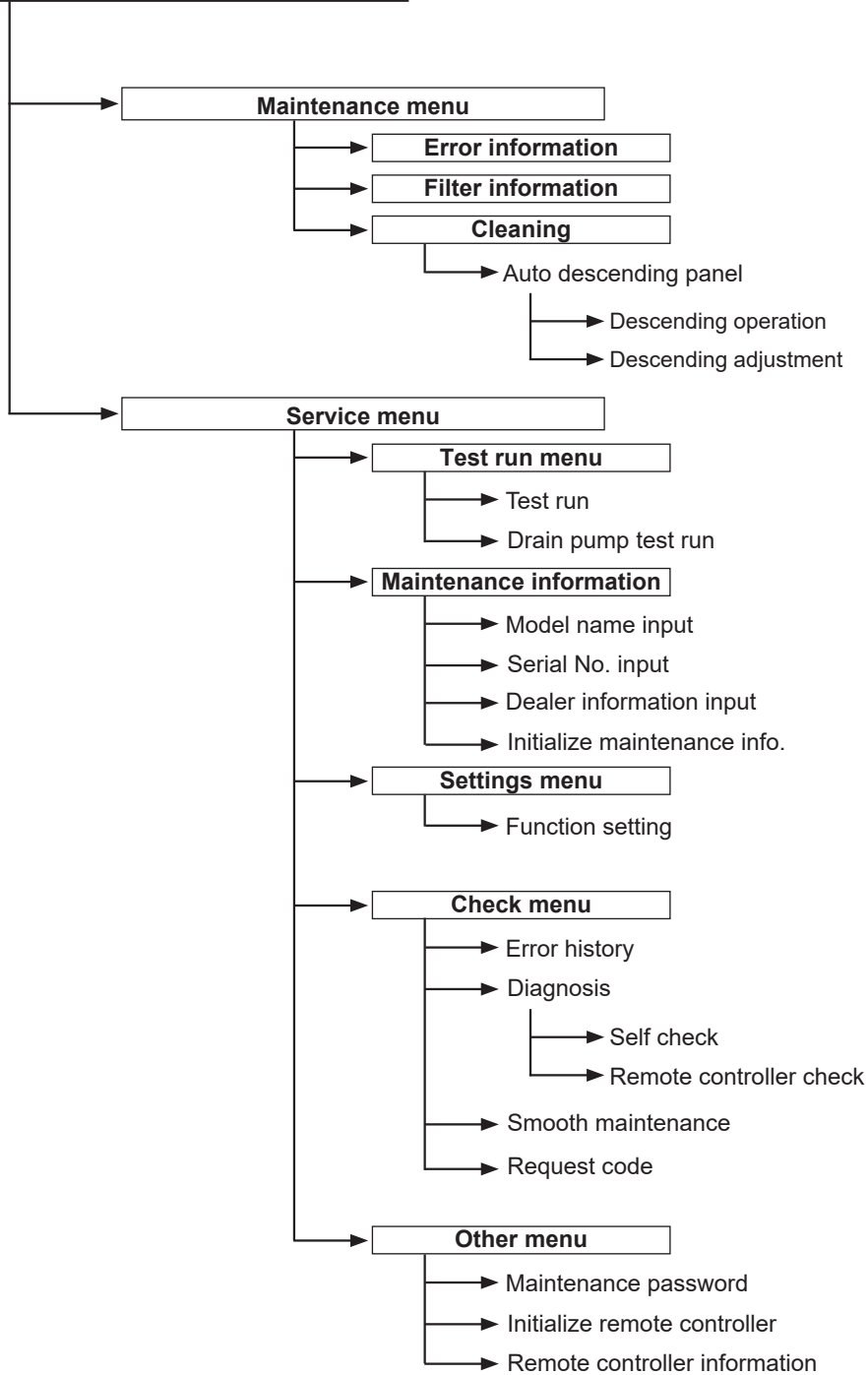

Not all functions are available on all models of indoor units.

Main menu list

Main menu	Setting and display items		Setting details
Operation	Vane · Louver · Vent. (Lossnay)		<p>Use to set the vane angle.</p> <ul style="list-style-type: none"> • Select a desired vane setting. <p>Use to turn ON/OFF the louver.</p> <ul style="list-style-type: none"> • Select a desired setting from "ON" and "OFF." <p>Use to set the amount of ventilation.</p> <ul style="list-style-type: none"> • Select a desired setting from "Off," "Low," and "High."
	High power ^{*3}		<p>Use to reach the comfortable room temperature quickly.</p> <ul style="list-style-type: none"> • Units can be operated in the High-power mode for up to 30 minutes.
	Comfort	Manual vane angle	Use to fix each vane angle.
		3D i-See sensor	<p>Use to set the following functions for 3D i-See sensor.</p> <ul style="list-style-type: none"> • Air distribution • Energy saving option • Seasonal airflow
Timer	Timer	ON/OFF timer ^{*1}	<p>Use to set the operation ON/OFF times.</p> <ul style="list-style-type: none"> • Time can be set in 5-minute increments.
		Auto-Off timer	<p>Use to set the Auto-Off time.</p> <ul style="list-style-type: none"> • Time can be set to a value from 30 to 240 in 10-minute increments.
	Weekly timer ^{*1, *2}		<p>Use to set the weekly operation ON/OFF times.</p> <ul style="list-style-type: none"> • Up to 8 operation patterns can be set for each day. (Not valid when the ON/OFF timer is enabled.)
	OU silent mode ^{*1, *3}		<p>Use to set the time periods in which priority is given to quiet operation of outdoor units over temperature control. Set the Start/Stop times for each day of the week.</p> <ul style="list-style-type: none"> • Select the desired silent level from "Normal," "Middle," and "Quiet."
Energy saving	Restriction	Temp. range ^{*2}	<p>Use to restrict the preset temperature range.</p> <ul style="list-style-type: none"> • Different temperature ranges can be set for different operation modes.
		Operation locked	<p>Use to lock selected functions.</p> <ul style="list-style-type: none"> • The locked functions cannot be operated.
	Energy saving	Auto return ^{*2}	<p>Use to get the units to operate at the preset temperature after performing energy saving operation for a specified time period.</p> <ul style="list-style-type: none"> • Time can be set to a value from 30 and 120 in 10-minute increments. (This function will not be valid when the preset temperature ranges are restricted.)
		Schedule ^{*1, *3}	<p>Set the start/stop times to operate the units in the energy saving mode for each day of the week, and set the energy saving rate.</p> <ul style="list-style-type: none"> • Up to 4 energy saving operation patterns can be set for each day. • Time can be set in 5-minute increments. • Energy saving rate can be set to a value from 0% or 50 to 90% in 10% increments.
Initial setting	Basic setting	Main/Sub	When connecting 2 remote controllers, one of them needs to be designated as a sub controller.
		Clock	Use to set the current time.
		Daylight saving time	Set the daylight saving time.
		Administrator password	<p>The administrator password is required to make the settings for the following items.</p> <ul style="list-style-type: none"> • Timer setting • Energy saving setting • Weekly timer setting • Restriction setting • Outdoor unit silent mode setting

*1 Clock setting is required.

*2 2°F (1°C) increments.

*3 This function is available only when certain outdoor units are connected.

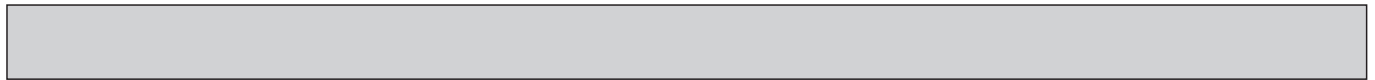

Main menu	Setting and display items		Setting details
Initial setting	Display setting	Main display	Use to switch between "Full" and "Basic" modes for the Main display, and use to change the background colors of the display to black.
		Display details	Make the settings for the remote controller related items as necessary. Clock: The initial settings are "Yes" and "24h" format. Temperature: Set either Celsius (°C) or Fahrenheit (°F). Room temp. : Set Show or Hide. Auto mode: Set the Auto mode display or Only Auto display.
		Contrast • Brightness	Use to adjust screen contrast and brightness.
		Language selection	Use to select the desired language.
	Operation setting	Auto mode	Whether or not to use the Auto mode can be selected by using the button. This setting is valid only when indoor units with the Auto mode function are connected.
		Setback mode	Whether or not to use the Setback mode can be selected by using the button. This setting is valid only when indoor units with the Setback mode function are connected.
Maintenance	Error information		Use to check error information when an error occurs. • Check code, error source, refrigerant address, unit model, manufacturing number, contact information (dealer's phone number) can be displayed. (The unit model, manufacturing number, and contact information need to be registered in advance to be displayed.)
	Filter information		Use to check the filter status. • The filter sign can be reset.
	Cleaning	Auto descending panel	Use to lift and lower the auto descending panel (Optional parts).
Service	Test run		Select "Test run" from the Service menu to bring up the Test run menu. • Test run • Drain pump test run
	Input maintenance		Select "Input maintenance Info." from the Service menu to bring up the Maintenance information screen. The following settings can be made from the Maintenance Information screen. • Model name input • Serial No. input • Dealer information input • Initialize maintenance info.
	Settings	Function setting	Make the settings for the indoor unit functions via the remote controller as necessary.
	Check	Error history	Display the error history and execute "delete error history".
		Diagnosis	Self check: Error history of each unit can be checked via the remote controller. Remote controller check: When the remote controller does not work properly, use the remote controller checking function to troubleshoot the problem.
		Smooth maintenance * ₁	Use to display the maintenance data of indoor/outdoor units.
		Request code * ₁	Use to check operation data such as thermistor temperature and error information.
	Others	Maintenance password	Use to change the maintenance password.
		Initialize remote controller	Use to initialize the remote controller to the factory shipment status.
		Remote controller information	Use to display the remote controller model name, software version, and serial number.

*₁ This function is available only when certain outdoor units are connected.

<PAR-SL97A-E>

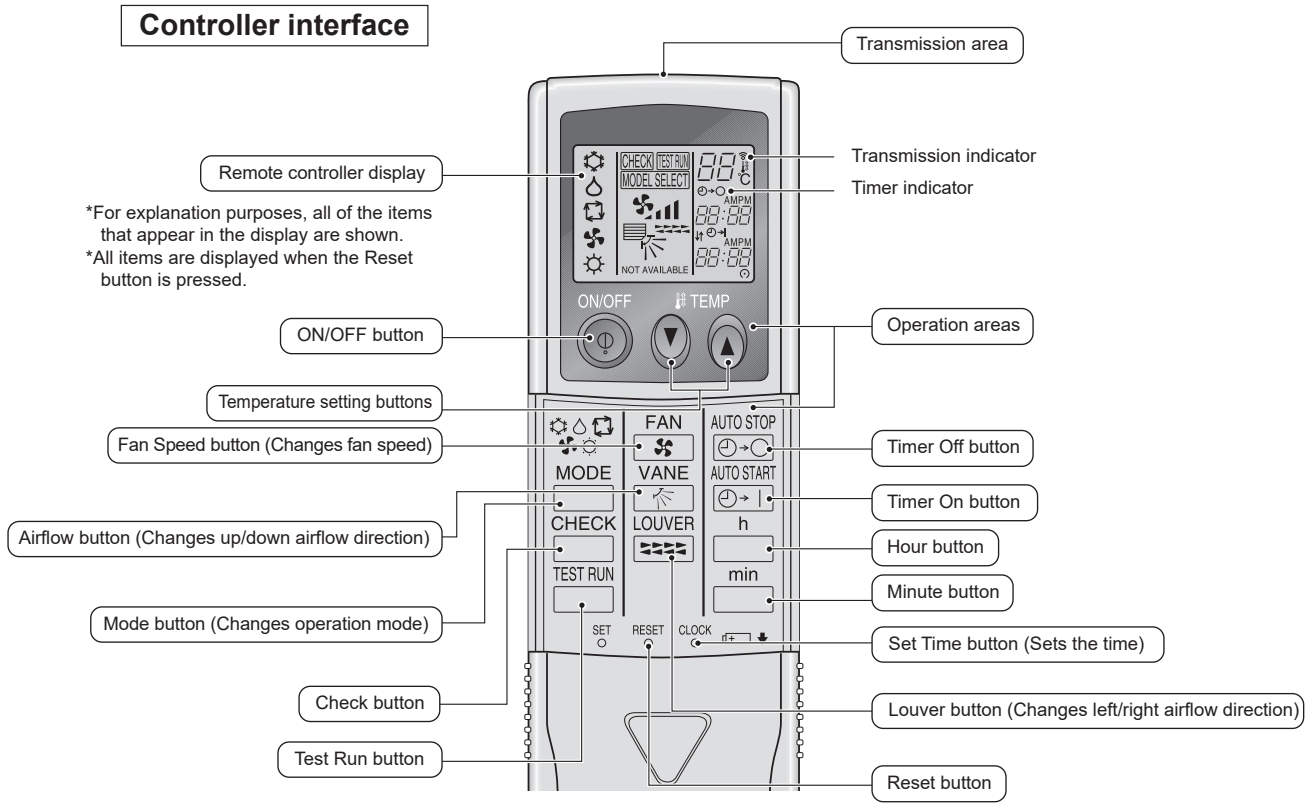

- When using the wireless remote controller, point it towards the receiver on the indoor unit.
- If the remote controller is operated within approximately two minutes after power is supplied to the indoor unit, the indoor unit may beep twice as the unit is performing the initial automatic check.
- The indoor unit beeps to confirm that the signal transmitted from the remote controller has been received. Signals can be received up to approximately 7 meters in a direct line from the indoor unit in an area 45° to the left and right of the unit. However, illumination such as fluorescent lights and strong light can affect the ability of the indoor unit to receive signals.
- If the operation lamp near the receiver on the indoor unit is blinking, the unit needs to be inspected. Consult your dealer for service.
- Handle the remote controller carefully! Do not drop the remote controller or subject it to strong shocks. In addition, do not get the remote controller wet or leave it in a location with high humidity.
- To avoid misplacing the remote controller, install the holder included with the remote controller on a wall and be sure to always place the remote controller in the holder after use.

<PAR-SL100A-E>

Controller interface

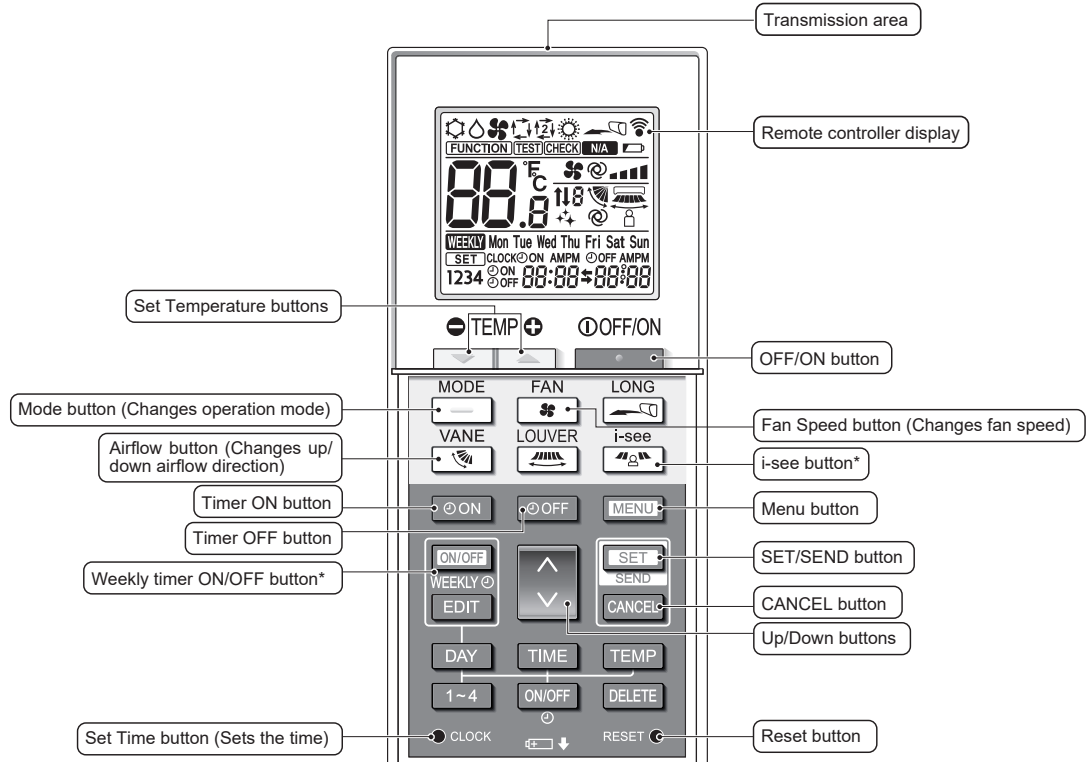

Note:

* This button is enabled or disabled depending on the model of the indoor unit.

Display

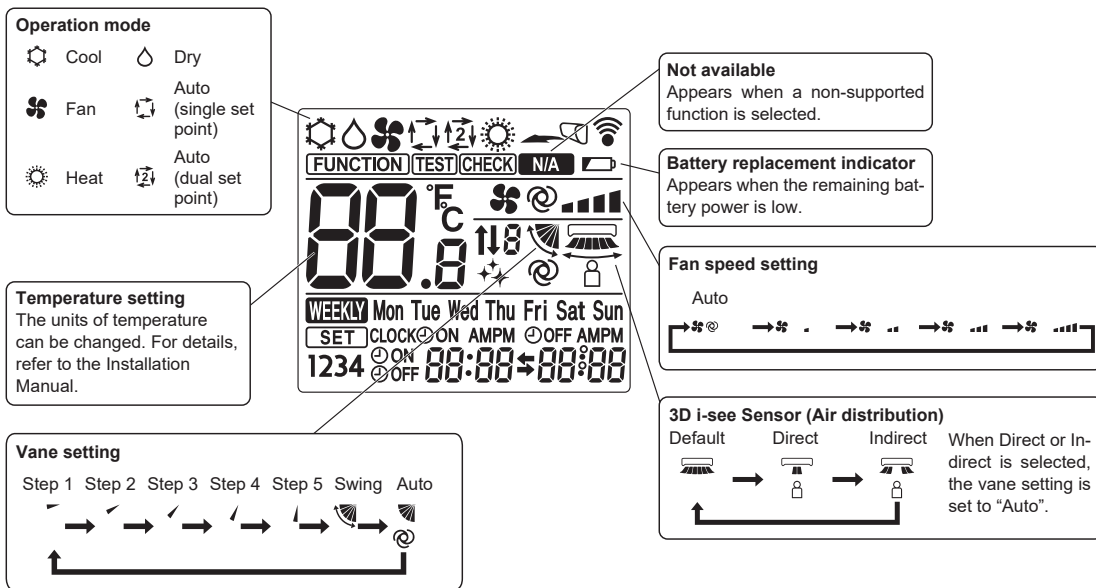

15-2. ERROR INFORMATION

**When an error occurs, the following screen will appear.
Check the error status, stop the operation, and consult your dealer.**

1. Check code, error unit, refrigerant address, unit model name, and serial number will appear.
The model name and serial number will appear only if the information has been registered.

Press the **F1** or **F2** button to go to the next page.

Error information		1/2
Error code	A3	
Error unit	IU	Unit#1
Time Occurred	02/01	4:48
Model name		
Serial No.		
Reset error: Reset button		
▼ Page ▲	Reset	

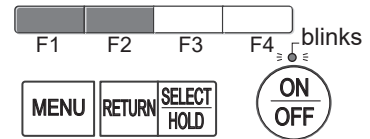

Contact information (dealer's phone number) will appear if the information has been registered.

Error information		2/2
Contact information		
Dealer		
Tel		
Reset error: Reset button		
▼ Page ▲	Reset	

2. Press the **F4** button or the [ON/OFF] button to reset the error that is occurring.

Errors cannot be reset while the ON/OFF operation is prohibited.

Error information		1/2
Error code	A3	
Error unit	IU	Unit#1
Time Occurred	02/01	4:48
Model name		
Serial No.		
Reset error: Reset button		
▼ Page ▲	Reset	

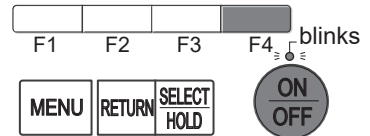

Select "OK" with the **F4** button.

Error reset	
Reset current error?	
Cancel	OK

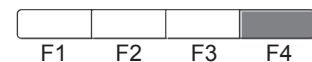

Error reset	
Error reset	
Main menu: MENU	

Navigating through the screens

- To go back to the Main menu [MENU] button

• Checking the error information

While no errors are occurring, page 2/2 of the error information can be viewed by selecting "Error information" from the Maintenance menu. Errors cannot be reset from this screen.

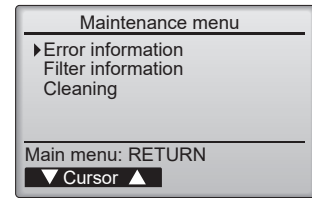

15-3. SERVICE MENU

Maintenance password is required

1. Select "Service" from the Main menu, and press the [SELECT] button.

*At the main display, the menu button and select "Service" to make the maintenance setting.

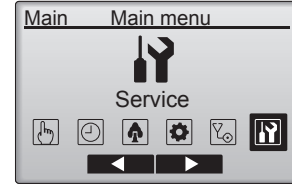

2. When the Service menu is selected, a window will appear asking for the password.

To enter the current maintenance password (4 numerical digits), move the cursor to the digit you want to change with the [F1] or [F2] button.



Set each number (0 through 9) with the [F3] or [F4] button.



Then, press the [SELECT] button.

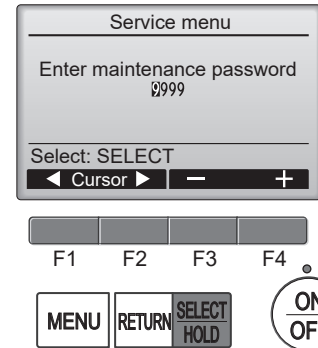

Note: The initial maintenance password is "9999". Change the default password as necessary to prevent unauthorized access. Have the password available for those who need it.

: If you forget your maintenance password, you can initialize the password to the default password "9999" by pressing and holding the [F1] button for 10 seconds on the maintenance password setting screen.

3. If the password matches, the Service menu will appear.

The type of menu that appears depends on the connected indoor units' type.

Note: Air conditioning units may need to be stopped to make only at "Settings". There may be some settings that cannot be made when the system is centrally controlled.



A screen will appear that indicates the setting has been saved.

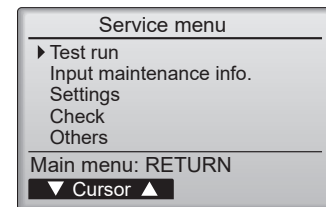

Navigating through the screens

- To go back to the Service menu [MENU] button
- To return to the previous screen..... [RETURN] button

15-4. TEST RUN

15-4-1. PAR-40MAA

1. Select "Service" from the Main menu, and press the [SELECT] button.



Select "Test run" with the **F1** or **F2** button, and press the [SELECT] button.

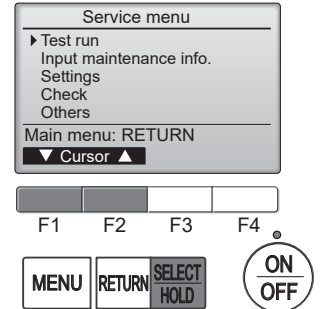

2. Select "Test run" with the **F1** or **F2** button, and press the [SELECT] button.

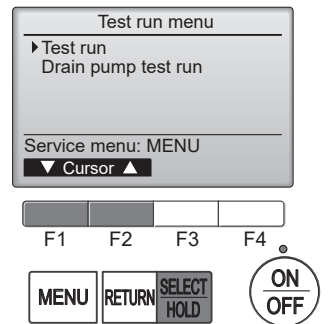

Test run operation

Press the **F1** button to go through the operation modes in the order of "Cool and Heat".

Cool mode: Check the cold air blows out.
Heat mode: Check the heat blows out.

Check the operation of the outdoor unit's fan.



Press the [SELECT] button and open the Vane setting screen.

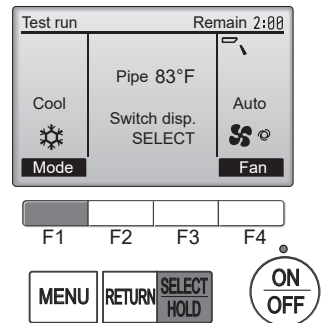

Auto vane check

Check the auto vane with the **F1** **F2** buttons.



Press the [RETURN] button to return to "Test run operation".



Press the [ON/OFF] button.

When the test run is completed, the "Test run menu" screen will appear.





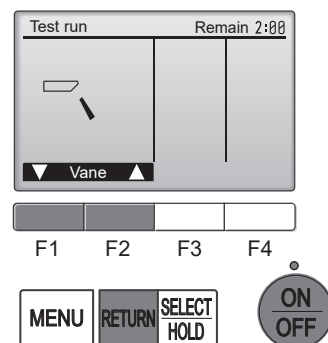



The test run will automatically stop after 2 hours.

*The function is available only for the model with vanes.



15-4-2. PAR-SL97A-E

Measure an impedance between the power supply terminal block on the outdoor unit and ground with a 500V Megger and check that it is equal to or greater than 1.0MΩ.







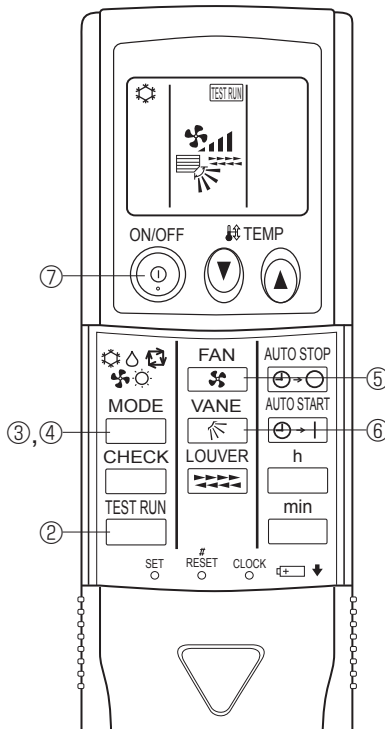



- ① Turn on the main power to the unit.
- ② Press the  button twice continuously.
(Start this operation from the status of remote controller display turned off.)
A  and current operation mode are displayed.
- ③ Press the  () button to activate ^{COOL} mode, then check whether cool air blows out from the unit.
- ④ Press the  () button to activate ^{HEAT} mode, then check whether warm air blows out from the unit.
- ⑤ Press the  button and check whether strong air blows out from the unit.
- ⑥ Press the  button and check whether the auto vane operates properly.
- ⑦ Press the ON/OFF button to stop the test run.

Note:

- Point the remote controller towards the indoor unit receiver while following steps ② to ⑦.
- It is not possible to run in FAN, DRY or AUTO mode.



15-4-3. PAR-SL100A-E

1. Press the  button ① to stop the air conditioner.
 - If the weekly timer is enabled (^{WEEKLY} is on), press the  button ③ to disable it (^{WEEKLY} is off).
2. Press the  button ② for 5 seconds.
 - ^{CHECK} comes on and the unit enters the service mode.
3. Press the  button ②.
 - ^{TEST} comes on and the unit enters the test run mode.
4. Press the following buttons to start the test run.
 - : Switch the operation mode between cooling and heating and start the test run.
 - : Switch the fan speed and start the test run.
 - : Switch the airflow direction and start the test run.
 - : Switch the louver and start the test run.
 - : Start the test run.
5. Stop the test run.
 - Press the  button ① to stop the test run.
 - After 2 hours, the stop signal is transmitted.

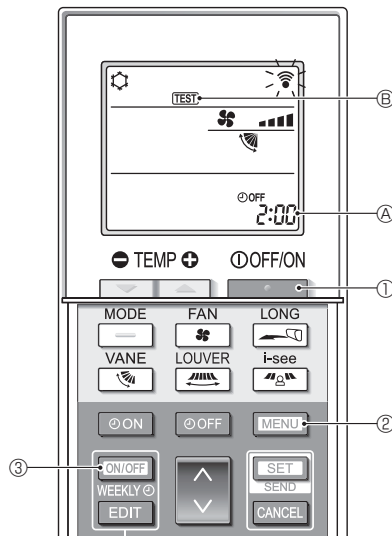

15-5. FUNCTION SETTING

15-5-1. PAR-40MAA

1. Select "Service" from the Main menu, and press the [SELECT] button.

Select "Setting" from the Service menu, and press the [SELECT] button.

Select "Function setting", and press the [SELECT] button.

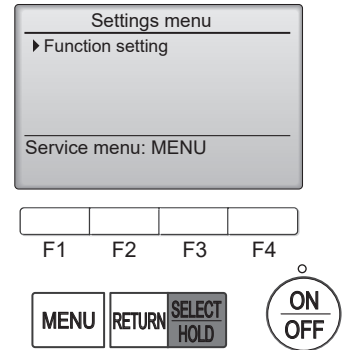

2. Set the indoor unit refrigerant addresses and unit numbers with the [F1] through [F4] buttons, and then press the [SELECT] button to confirm the current setting.

Note: Checking the indoor unit No.

When the [SELECT] button is pressed, the target indoor unit will start fan operation. If the unit is common or when running all units, all indoor units for the selected refrigerant address will start fan operation.

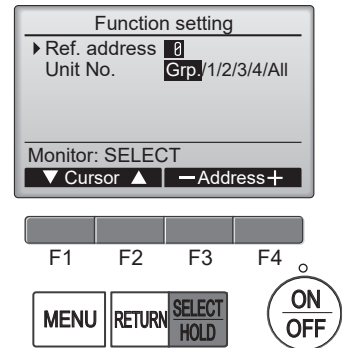

3. When data collection from the indoor units is completed, the current settings appears highlighted.
 Non-highlighted items indicate that no function settings are made.
 Screen appearance varies depending on the "Unit No." setting.

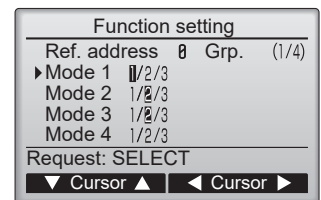

4. Use the [F1] or [F2] button to move the cursor to select the mode number, and change the setting number with the [F3] or [F4] button.

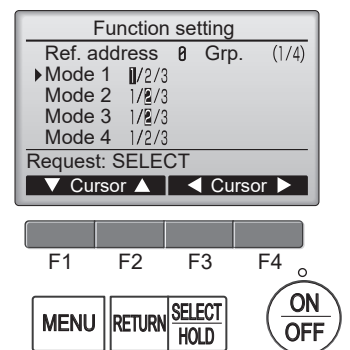

5. When the settings are completed, press the [SELECT] button to send the setting data from the remote controller to the indoor units.
 When the transmission is successfully completed, the screen will return to the Function setting screen.

Note:

- Make the above settings only on Mr. Slim units as necessary.
- The above function settings are not available for the CITY MULTI units.
- Table 1 summarizes the setting options for each mode number. Refer to the indoor unit Installation Manual for the detailed information about initial settings, mode numbers, and setting numbers for the indoor units.
- Be sure to write down the settings for all functions if any of the initial settings has been changed after the completion of installation work.

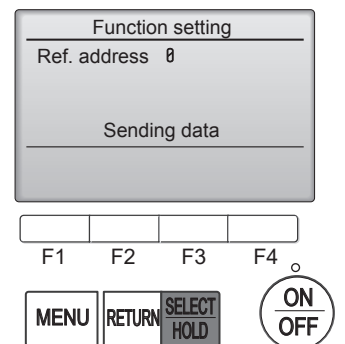

15-5-2. PAR-SL97A-E

Functions can be selected with the wireless remote controller. Function selection using wireless remote controller is available only for refrigerant system with wireless function. Refrigerant address cannot be specified by the wireless remote controller.

[Flow of function selection procedure]

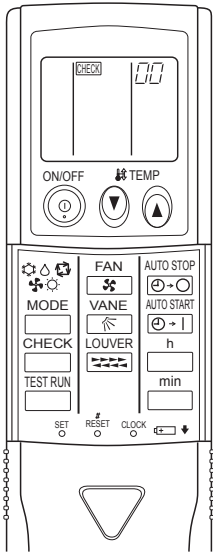

The flow of the function selection procedure is shown below. This example shows how to turn off the function that raises the set temperature by 4 degrees during HEAT operation. The procedure is given after the flow chart.

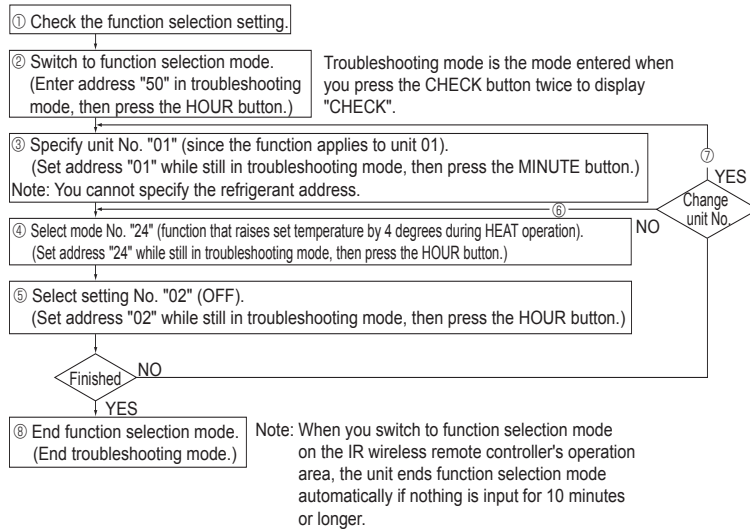

[Operating instructions]

① Check the function settings.

② Press the button twice continuously. → **CHECK** is lit and "00" blinks.

Press the **TEMP** button once to set "50". Direct the IR wireless remote controller toward the receiver of the indoor unit and press the button.

③ Set the unit number.

Press the **TEMP** button to set the unit number. (Press "01" to specify the indoor unit whose unit number is 01.)

Direct the IR wireless remote controller toward the receiver of the indoor unit and press the button.

(By setting unit number with the button, specified indoor unit starts performing fan operation.

Detect which unit is assigned to which number using this function. If unit number is set to AL, all the indoor units in same refrigerant system start performing fan operation simultaneously.)

Notes:

1. If a unit number that cannot be recognized by the unit is entered, 3 beeps of 0.4 seconds will be heard. Reenter the unit number setting.
2. If the signal was not received by the sensor, you will not hear a beep or a "double ping sound" may be heard. Reenter the unit number setting.

④ Select a mode.

Press the **TEMP** button to set a mode. Press "24" to turn on the function that raises the set temperature by 4 degrees during heat operation. Direct the IR wireless remote controller toward the sensor of the indoor unit and press the button.

→ The sensor-operation indicator will blink and beeps will be heard to indicate the current setting number.

Current setting number: 1 = 1 beep (one second)
2 = 2 beeps (one second each)
3 = 3 beeps (one second each)

Notes:

1. If a mode number that cannot be recognized by the unit is entered, 3 beeps of 0.4 seconds will be heard. Reenter the mode number.
2. If the signal was not received by the sensor, you will not hear a beep or a "double ping sound" may be heard. Reenter the mode number.

⑤ Select the setting number.

Press the **TEMP** button to select the setting number. (02: Not available)

Direct the IR wireless remote controller toward the receiver of the indoor unit and press the button.

→ The sensor-operation indicator will blink and beeps will be heard to indicate the setting number.

Setting number: 1 = 2 beeps (0.4 seconds each)
2 = 2 beeps (0.4 seconds each, repeated twice)
3 = 2 beeps (0.4 seconds each, repeated 3 times)

Notes:

1. If a setting number that cannot be recognized by the unit is entered, the setting will turn back to the original setting.
2. If the signal was not received by the sensor, you will not hear a beep or a "double ping sound" may be heard. Reenter the setting number.

⑥ Repeat steps ④ and ⑤ to make an additional setting without changing unit number.

⑦ Repeat steps ③ to ⑤ to change unit number and make function settings on it.

⑧ Complete the function settings

Press button.

Do not use the wireless remote controller for 30 seconds after completing the function setting.

15-5-3. PAR-SL100A-E

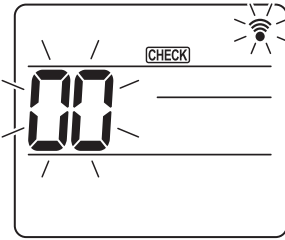

Fig. 15-1

1. Going to the function select mode

Press the **MENU** button between of 5 seconds.

(Start this operation from the status of remote controller display turned off.)

[CHECK] is lit and "00" blinks. (Fig. 15-1)

Press the **↓** button to set the "50".

Direct the wireless remote controller toward the receiver of the indoor unit and press the **SET** button.

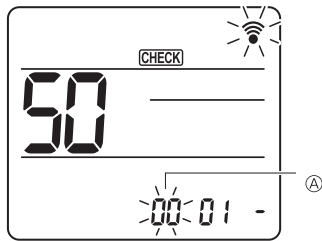

Fig. 15-2

2. Setting the unit number

Press the **↓** button to set unit number **A**. (Fig. 15-2)

Direct the wireless remote controller toward the receiver of the indoor unit and press the **SET** button.

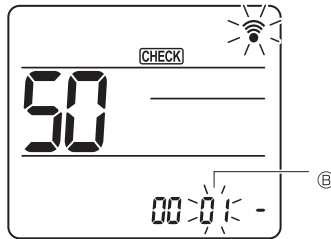

Fig. 15-3

3. Select a mode

Press the **↓** button to set Mode number **B**. (Fig. 15-3)

Direct the wireless remote controller toward the receiver of the indoor unit and press the **SET** button.

Current setting number:

1=1 beep (1 second)

2=2 beep (1 second each)

3=3 beep (1 second each)

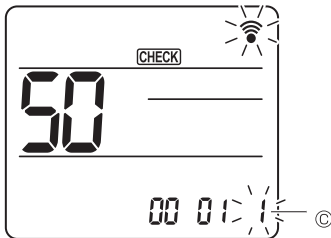

Fig. 15-4

4. Selecting the setting number

Use the **↓** button to change the Setting number **C**. (Fig. 15-4)

Direct the wireless remote controller toward the receiver of the indoor unit and press the **SET** button.

5. To select multiple functions continuously

Repeat select **3** and **4** to change multiple function settings continuously.

6. Complete function selection

Direct the wireless remote controller toward the sensor of the indoor unit and press the **OFF/ON** button.

Note: Be sure to write down the settings for all functions if any of the initial settings has been changed after the completion of installation work.

15-6. ERROR HISTORY

1. Select "Service" from the Main menu, and press the [SELECT] button.



Select "Check" with the **F1** or **F2** button, and press the [SELECT] button.

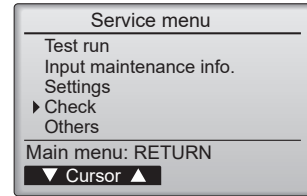

2. Select "Error history" with the **F1** or **F2** button, and press the [SELECT] button.

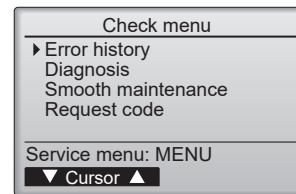

3. 16 error history records will appear.

4 records are shown per page, and the top record on the first page indicates the latest error record.

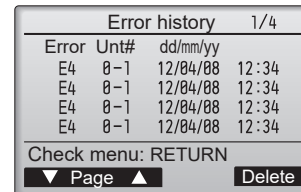

4. Deleting the error history

To delete the error history, press the **F4** button (Delete) on the screen that shows error history.

A confirmation screen will appear asking if you want to delete the error history.



Press the **F4** button (OK) to delete the history.



"Error history deleted" will appear on the screen.

Press the [RETURN] button to go back to the Check menu screen.

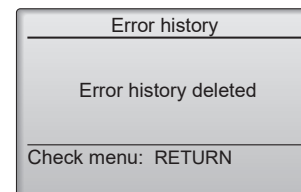
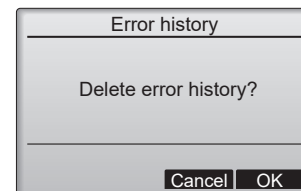

15-7. SELF-DIAGNOSIS

15-7-1. PAR-40MAA

1. Select "Service" from the Main menu,
and press the [SELECT] button.



Select "Check" from the Service menu,
and press the [SELECT] button.



Select "Diagnosis" from the Check menu,
and press the [SELECT] button.



Select "Self check" with the [F1] or [F2] button,
and press the [SELECT] button.

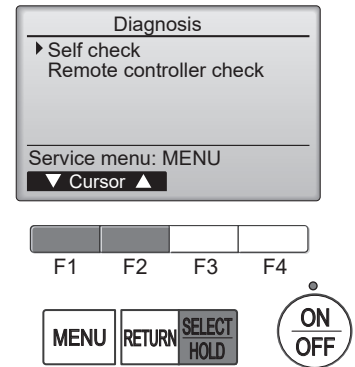

2. With the [F1] or [F2] button, enter the refrigerant address, and press the [SELECT] button.

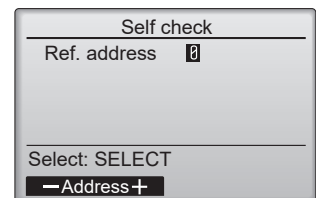

3. Check code, unit number, attribute will appear.
"-" will appear if no error history is available.

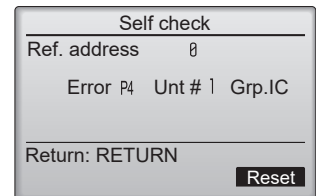

When there is no error history

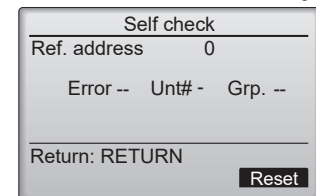

4. Resetting the error history

Press the [F4] button (Reset) on the screen that shows the error history.



A confirmation screen will appear asking if you want to delete the error history.



Press the [F4] button (OK) to delete the error history.

If deletion fails, "Request rejected" will appear.
"Unit not exist" will appear if no indoor units that are correspond to the entered address are found.

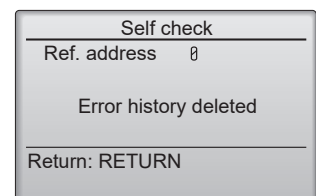
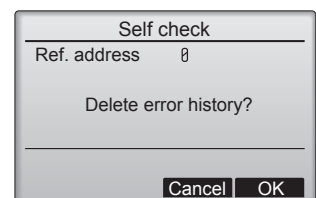

Navigating through the screens

- To go back to the Service menu [MENU] button
- To return to the previous screen..... [RETURN] button

15-7-2. PAR-SL97A-E

When a malfunction occurs to air conditioner, both indoor unit and outdoor unit will stop and operation lamp blinks to inform unusual stop.

<Malfunction-diagnosis method at maintenance service>

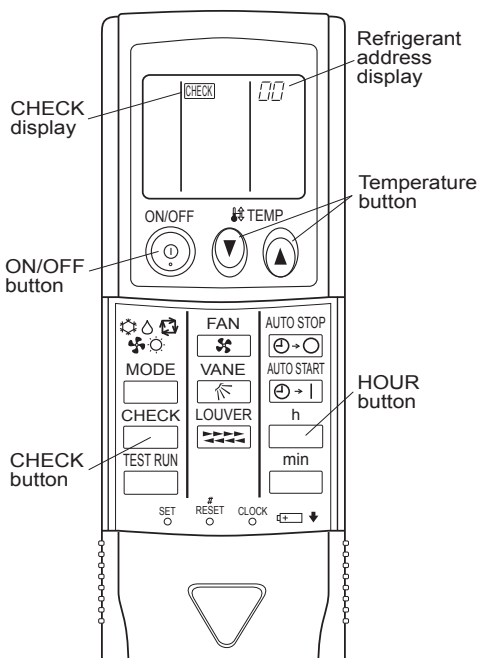

[Procedure]

- Press the CHECK button twice.
 - "CHECK" lights, and refrigerant address "00" blinks.
 - Check that the remote controller's display has stopped before continuing.
- Press the TEMP (up/down) buttons.
 - Select the refrigerant address of the indoor unit for the self-diagnosis. Note: Set refrigerant address using the outdoor unit's DIP switch (SW1). (For more information, see the outdoor unit installation manual.)
- Point the remote controller at the sensor on the indoor unit and press the HOUR button.
 - If an air conditioner error occurs, the indoor unit's sensor emits an intermittent buzzer sound, the operation light blinks, and the check code is output. (It takes 3 seconds at most for check code to appear.)
- Point the remote controller at the sensor on the indoor unit and press the ON/OFF button.
 - The check mode is cancelled.

15-7-3. PAR-SL100A-E

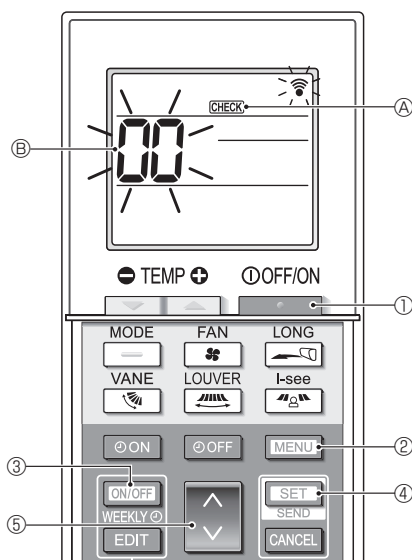

- Press the (ON/OFF) button ① to stop the air conditioner.
 - If the weekly timer is enabled (WEEKLY is on), press the (ON/OFF WEEKLY) button ③ to disable it (WEEKLY is off).
- Press the (MENU) button ② for 5 seconds.
 - (CHECK) (A) comes on and the unit enters the self-check mode.
- Press the (down arrow) button ⑤ to select the refrigerant address (M-NET address) (B) of the indoor unit for which you want to perform the self-check.
- Press the (SET) button ④.
 - If an error is detected, the check code is indicated by the number of beeps from the indoor unit and the number of blinks of the OPERATION INDICATOR lamp.
- Press the (ON/OFF) button ①.
 - (CHECK) (A) and the refrigerant address (M-NET address) (B) go off and the self-check is completed.

15-8. REMOTE CONTROLLER CHECK

If operations cannot be completed with the remote controller, diagnose the remote controller with this function.

1. Select "Service" from the Main menu, and press the [SELECT] button.

Select "Check" from the Service menu, and press the [SELECT] button.

Select "Diagnosis" from the Check menu, and press the [SELECT] button.

Select "Remote controller check" with the **F1** or **F2** button, and press the [SELECT] button.

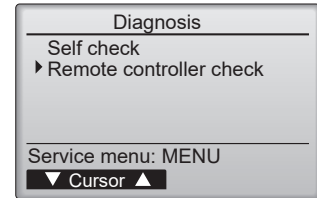

2. Select "Remote controller check" from the Diagnosis menu, and press the [SELECT] button to start the remote controller check and see the check results.

To cancel the remote controller check and exit the "Remote controller check" menu screen, press the [MENU] or the [RETURN] button.

The remote controller will not reboot itself.

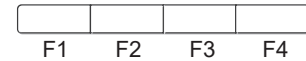
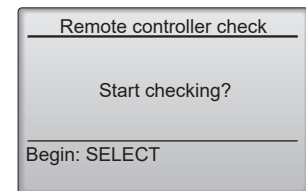

3.
 - OK: No problems are found with the remote controller. Check other parts for problems.
 - E3, 6832: There is noise on the transmission line, or the indoor unit or another remote controller is faulty. Check the transmission line and the other remote controllers.
 - NG (ALL0, ALL1): Send-receive circuit fault. The remote controller needs replacing.
 - ERC: The number of data errors is the discrepancy between the number of bits in the data transmitted from the remote controller and that of the data that was actually transmitted over the transmission line. If data errors are found, check the transmission line for external noise interference.

Remote controller check results screen

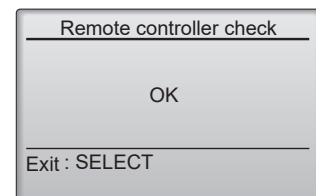

If the [SELECT] button is pressed after the remote controller check results are displayed, remote controller check will end, and the remote controller will automatically reboot itself.

Check the remote controller display and see if anything is displayed (including lines). Nothing will appear on the remote controller display if the correct voltage (8.5–12 VDC) is not supplied to the remote controller. If this is the case, check the remote controller wiring and indoor units.

15-9. SMOOTH MAINTENANCE

1. Select "Service" from the Main menu, and press the [SELECT] button.

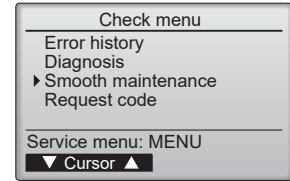

Select "Check" with the [F1] or [F2] button, and press the [SELECT] button.



Select "Smooth maintenance" with the [F1] or [F2] button, and press the [SELECT] button.



2. Set each item.

Select the item to be changed with the [F1] or [F2] button.

Select the required setting with the [F3] or [F4] button.

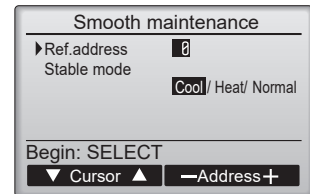

- <Ref.address>setting [0] – [15]
- <Stable mode>setting [Cool] / [Heat] / [Normal]

Press the [SELECT] button, Fixed operation will start.
Note: Stable mode will take approx. 20 minutes.

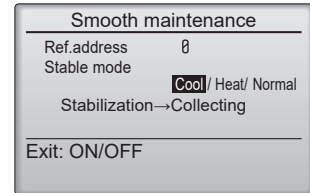

3. The operation data will appear.

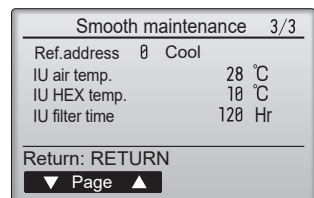
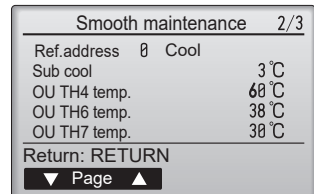
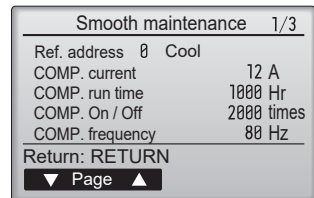

Navigating through the screens

- To go back to the Service menu [MENU] button
- To return to the previous screen [RETURN] button

■ Refrigerant address
Single refrigerant system

In the case of single refrigerant system, the refrigerant address is "00" and no operation is required.

Simultaneous twin, triple units belong to this category (single refrigerant system).

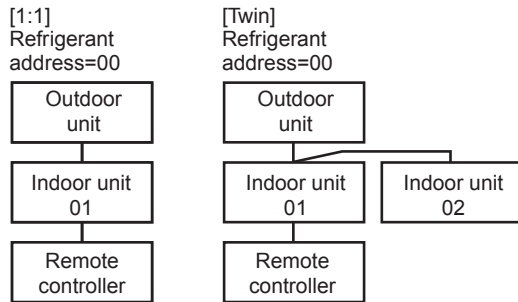

Multi refrigerant system (group control)

Up to 16 refrigerant systems (16 outdoor units) can be connected as a group by 1 remote controller. To check or set the refrigerant addresses.

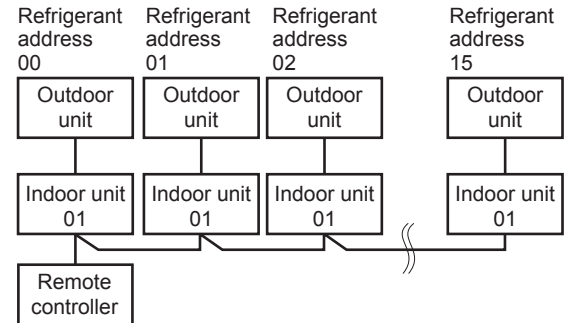

15-10. REQUEST CODE

Details on the operation data including each thermistor temperature and error history can be confirmed with the remote controller.

1. Select "Service" from the Main menu, and press the [SELECT] button.

Select "Check" with the **F1** or **F2** button, and press the [SELECT] button.

Select "Request code" with the **F1** or **F2** button, and press the [SELECT] button.

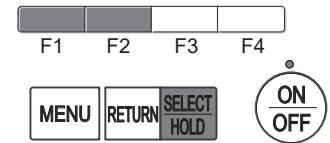
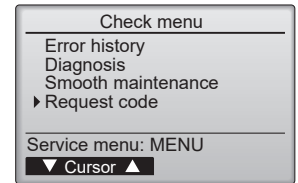

2. Set the Refrigerant address and Request code.

Select the item to be changed with the **F1** or **F2** button.

Select the required setting with the **F3** or **F4** button.

- <Ref.address>setting [0] – [15]
- <Request code>setting

Press the [SELECT] button, Data will be collected and displayed.

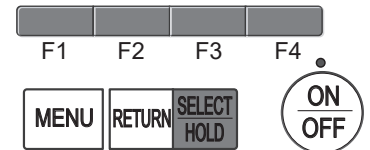
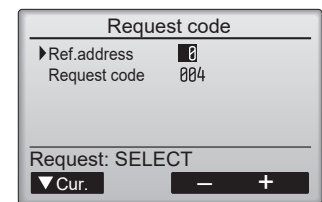

Request code: 004
Discharge temperature: 69°C

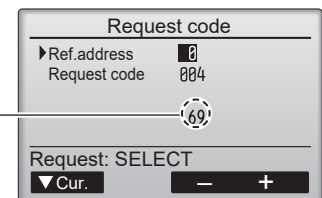

mitsubishi electric corporation

HEAD OFFICE: TOKYO BUILDING, 2-7-3, MARUNOUCHI, CHIYODA-KU, TOKYO 100-8310, JAPAN

©Copyright 2020 MITSUBISHI ELECTRIC CORPORATION
Issued: May 2022 No. OCH754 REVISED EDITION-C
Issued: Jun. 2021 No. OCH754 REVISED EDITION-B
Issued: Dec. 2020 No. OCH754 REVISED EDITION-A
Published: Oct. 2020 No. OCH754
Made in Japan

Specifications are subject to change without notice.