

**PLA-A30EA7 & PUZ-HA30NKA**  
**30,000 BTU/H 3' X 3' CEILING CASSETTE**  
**30,000 BTU/H HYPER-HEATING UNIVERSAL OUTDOOR**



Job Name:

System Reference:

Date:



Indoor Unit.....PLA-A30EA7

Outdoor Unit.....PUZ-HA30NKA

**INDOOR UNIT FEATURES**

- Space-efficient ductless installation
- Equipped with 3D i-see Sensor® for enhanced comfort and energy efficiency
- Airflow settings for high and low ceiling applications
- Individual vane settings for direct/indirect airflow control or variable airflow patterns
- Knockouts for outside-air intake and branch-duct run
- Filter indicator signal
- Easy-to-clean, washable filter (optional high-efficiency filter available - requires multi-function casement)
- Built-in condensate lift mechanism
- Ideal for retail shops, classrooms, office spaces, conference centers, building lobbies, and more
- Multiple control options available:
  - kumo cloud® smart device app for remote access
  - Third-party interface options
  - Wired or wireless controllers

**OUTDOOR UNIT FEATURES**

- Variable speed INVERTER-driven compressor
- Wide heating range: heating performance down to -13°F (average of 80% heating capacity)
- High speed heating at start up: Hyper-Heating INVERTER® reduces the time for heating at start up by about half compared to standard models
- Power receiver pre-charged with refrigerant volume for piping length up to 70 ft.
- High pressure/temperature protection
- Built-in base pan heater
- Flash injection circuit provides efficient high heating capacities at low ambient temperatures

# SPECIFICATIONS: PLA-A30EA7 & PUZ-HA30NKA

Cooling at 95°F <sup>1</sup>	Maximum Capacity	BTU/H	30,000
	Rated Capacity	BTU/H	30,000
	Minimum Capacity	BTU/H	14,600
	Maximum Power Input	W	2,120
	Rated Power Input	W	2,120
	Moisture Removal	Pints/h	5.4
	Sensible Heat Factor		0.80
Heating at 47°F <sup>2</sup>	Power Factor	%	98.0/98.0
	Maximum Capacity	BTU/H	34,000
	Rated Capacity	BTU/H	32,000
	Minimum Capacity	BTU/H	14,200
	Maximum Power Input	W	2,510
	Rated Power Input	W	2,260
Heating at 17°F <sup>3</sup>	Power Factor	%	98.0/98.0
	Maximum Capacity	BTU/H	32,000
	Rated Capacity	BTU/H	20,600
	Maximum Power Input	W	3,935
Heating at 5°F <sup>4</sup>	Rated Power Input	W	2,365
	Maximum Capacity	BTU/H	32,000
Heating at -13°F <sup>7</sup>	Maximum Power Input	W	4,645
	Maximum Capacity	BTU/H	25,600
Efficiency	SEER		20.2
	EER <sup>1</sup>		14.1
	HSPF [IV]		9.8
	COP at 47°F <sup>2</sup>		4.1
	COP at 17°F at Maximum Capacity <sup>3</sup>		2.3
	COP at 5°F at Maximum Capacity <sup>4</sup>		2.0
	COP at -13°F at Maximum Capacity <sup>7</sup>		1.5
ENERGY STAR <sup>®</sup> Certified		Yes	
Electrical	Voltage, Phase, Frequency		208/230, 1, 60
	Guaranteed Voltage Range	V AC	198 - 253
	Voltage: Indoor - Outdoor, S1-S2	V AC	208/230
	Voltage: Indoor - Outdoor, S2-S3	V DC	24
	Short-circuit Current Rating [SCCR]	kA	5
	Recommended Fuse/Breaker Size (Outdoor)	A	35
	Recommended Wire Size [Indoor - Outdoor]	AWG	14
Power Supply		Indoor unit is powered by the outdoor unit	
Indoor Unit	MCA	A	1.0
	Fan Motor Full Load Amperage	A	0.59
	Fan Motor Output	W	120
	Fan Motor Type		DC Motor
	Airflow Rate at Cooling, Dry	CFM	570-670-780-880
	Airflow Rate at Cooling, Wet	CFM	530-630-740-840
	Airflow Rate at Heating, Dry	CFM	570-670-780-880
	Sound Pressure Level [Cooling]	dB[A]	28-32-35-38
	Sound Pressure Level [Heating]	dB[A]	28-32-35-38
	Drain Pipe Size	In. [mm]	1-1/4 [32]
	Condensate Lift Mechanism, Maximum Distance	In. [mm]	33-7/16 [849]
	Coating on Heat Exchanger		—
	External Finish Color		White Munsell 6.4Y 8.9/0.4
	Unit Dimensions	W x D x H: In. [mm]	33-1/16 // 37-13/32 x 33-1/16 // 37-13/32 x 11-3/4 // 1-9/16 [840 // 950 x 840 // 950 x 298 // 40]
	Package Dimensions	W x D x H: In. [mm]	35-9/16 // 39-6/16 x 34-5/16 // 38-3/16 x 16-9/16 // 4-12/16 [903 // 1000 x 871 // 970 x 421 // 121]
Unit Weight	Lbs. [kg]	56 // 11 [25 // 5]	
Package Weight	Lbs. [kg]	77 [35]	
Indoor Unit Operating Temperature Range	Cooling Intake Air Temp [Maximum / Minimum]*	°F	90 DB, 72 WB / 66 DB, 61 WB
	Heating Intake Air Temp [Maximum / Minimum]	°F	77 DB / 59 DB

**NOTES:**

AHRI Rated Conditions

(Rated data is determined at a fixed compressor speed)      <sup>1</sup>Cooling (Indoor // Outdoor)      °F      80 DB, 67 WB // 95 DB, 75 WB  
<sup>2</sup>Heating at 47°F (Indoor // Outdoor)      °F      70 DB, 60 WB // 47 DB, 43 WB  
<sup>3</sup>Heating at 17°F (Indoor // Outdoor)      °F      70 DB, 60 WB // 17 DB, 15 WB

Conditions

<sup>4</sup>Heating at 5°F (Indoor // Outdoor)      °F      70 DB, 60 WB // 5 DB, 4 WB  
<sup>5</sup>Heating at -4°F (Indoor // Outdoor)      °F      70 DB, 60 WB // -4 DB, -5 WB  
<sup>6</sup>Heating at -5°F (Indoor // Outdoor)      °F      70 DB, 60 WB // -5 DB, -6 WB  
<sup>7</sup>Heating at -13°F (Indoor // Outdoor)      °F      70 DB, 60 WB // -13 DB, -14 WB

\*Outdoor Unit Operating Temperature Range (Cooling Air Temp (Maximum / Minimum)):

- Wind baffles required to operate below 23°F DB in cooling mode.
- Refer to wind baffle documentation for further information.

\*\*Outdoor Unit Operating Temperature Range (Cooling Thermal Lock-out / Re-start Temperatures; Heating Thermal Lock-out / Re-start Temperatures):

- System cuts out in heating mode to avoid thermistor error and automatically restarts at these temperatures.

# SPECIFICATIONS: PLA-A30EA7 & PUZ-HA30NKA

Outdoor Unit	MCA	A	24.0
	MOCP	A	40
	Fan Motor Output	W	74
	Airflow Rate	CFM	3880/3880
	Refrigerant Control		LEV
	Defrost Method		Reverse Cycle
	Sound Pressure Level, Cooling <sup>1</sup>	dB(A)	52
	Sound Pressure Level, Heating <sup>2</sup>	dB(A)	53
	Compressor Type		Scroll
	Compressor Model		ANB33FJMMT
	Compressor Rated Load Amps	A	18
	Compressor Locked Rotor Amps	A	27.5
	Compressor Oil Type // Charge	oz.	FV50S // 1.4,47
	External Finish Color		Ivory Munsell 3Y 7.8/1.1
	Base Pan Heater		Built-in
	Unit Dimensions	W x D x H: In. [mm]	41-5/16 x 14-3/16 x 52-11/16 [1050 x 360 x 1338]
	Package Dimensions	W x D x H: In. [mm]	43 x 18 x 57 [1110 x 480 x 1440]
	Unit Weight	Lbs. [kg]	261 [118]
	Package Weight	Lbs. [kg]	285 [129]
	Outdoor Unit Operating Temperature Range	Cooling Air Temp [Maximum / Minimum]*	°F
Heating Air Temp [Maximum / Minimum]		°F	70 DB, 59 WB / -13 DB, -13 WB
Heating Thermal Lock-out / Re-start Temperatures**		°F	-22 / -13
Refrigerant	Type		R410A
	Charge	Lbs, oz	11, 7.0
	Chargeless Piping Length	Ft. [m]	0.0 [30.0]
	Additional Refrigerant Charge Per Additional Piping Length	oz./Ft. [g/m]	0.6 [56]
Piping	Gas Pipe Size O.D. [Flared]	In.[mm]	5/8 [15.88]
	Liquid Pipe Size O.D. [Flared]	In.[mm]	3/8 [9.52]
	Maximum Piping Length	Ft. [m]	245 [75]
	Maximum Height Difference	Ft. [m]	100 [30]
	Maximum Number of Bends		15

**NOTES:**

AHRI Rated Conditions

(Rated data is determined at a fixed compressor speed)

<sup>1</sup>Cooling (Indoor // Outdoor) °F 80 DB, 67 WB // 95 DB, 75 WB

<sup>2</sup>Heating at 47°F (Indoor // Outdoor) °F 70 DB, 60 WB // 47 DB, 43 WB

<sup>3</sup>Heating at 17°F (Indoor // Outdoor) °F 70 DB, 60 WB // 17 DB, 15 WB

Conditions

<sup>4</sup>Heating at 5°F (Indoor // Outdoor) °F 70 DB, 60 WB // 5 DB, 4 WB

<sup>5</sup>Heating at -4°F (Indoor // Outdoor) °F 70 DB, 60 WB // -4 DB, -5 WB

<sup>6</sup>Heating at -5°F (Indoor // Outdoor) °F 70 DB, 60 WB // -5 DB, -6 WB

<sup>7</sup>Heating at -13°F (Indoor // Outdoor) °F 70 DB, 60 WB // -13 DB, -14 WB

\*Outdoor Unit Operating Temperature Range (Cooling Air Temp (Maximum / Minimum)):

- Wind baffles required to operate below 23°F DB in cooling mode.
- Refer to wind baffle documentation for further information.

\*\*Outdoor Unit Operating Temperature Range (Cooling Thermal Lock-out / Re-start Temperatures; Heating Thermal Lock-out / Re-start Temperatures):

- System cuts out in heating mode to avoid thermistor error and automatically restarts at these temperatures.

## INDOOR UNIT ACCESSORIES: PLA-A30EA7

Control Interface	3-Pin Connector	PAC-715AD
	BACnet® and Modbus® Interface	PAC-UKPRC001-CN-1
	CN24 Relay Kit	CN24RELAY-KIT-CM3
	IT Extender	PAC-WHS01IE-E
	kumo station® for kumo cloud®	PAC-WHS01HC-E
	Lockdown bracket for remote controller	RCMKP1CB
	Remote Operation Adapter†	PAC-SF40RM-E
	Thermostat Interface	PAC-US444CN-1
	USNAP Adapter	PAC-WHS01UP-E
Remote Sensor	Wireless Interface for kumo cloud®	PAC-USWHS002-WF-2
	Flush Mount Temperature Sensor	PAC-USSEN001-FM-1
	Remote Temperature Sensor	PAC-SE41TS-E
Wired Remote Controller	Wireless temperature and humidity sensor for kumo cloud®	PAC-USWHS003-TH-1
	Deluxe Wired MA Remote Controller†	PAR-40MAAU
	Simple MA Remote Controller†	PAC-YT53CRAU-J
	Touch MA Controller†	PAR-CT01MAU-SB
Wireless Remote Controller	kumo touch™ RedLINK™ Wireless Controller	MHK2
	Wireless Remote Controller	PAR-SL100A-E
	Wireless Signal Receiver Panel	PAR-SR4LU-E
Casement	Multi-function Casement	PAC-SJ41TM-E
Condensate	Blue Diamond (Advanced) Mini Condensate Pump w/ Reservoir & Sensor (208/230V) [recommended]	X87-721
	Blue Diamond (MegaBlue Advanced) Condensate Pump w/ Reservoir & Sensor	X87-835
	Blue Diamond Sensor Extension Cable — 15 Ft.	C13-103
Disconnect Switch	(30A/600V/UL) [fits 2" X 4" utility box] - Black	TAZ-MS303
	(30A/600V/UL) [fits 2" X 4" utility box] - White	TAZ-MS303W
Filter	High Efficiency Filter Element	PAC-SH59KF-E
i-see Sensor® Panel	Grille with 3D i-see Sensor® (required)	PLP-41EAEU
Lineset	10' x 3/8" x 10' x 5/8" Lineset (Twin-Tube Insulation)††	MPLS385812T-10
	100' x 3/8" x 100' x 5/8" Lineset (Twin-Tube Insulation)††	MPLS385812T-100
	15' x 3/8" x 15' x 5/8" Lineset (Twin-Tube Insulation)††	MPLS385812T-15
	30' x 3/8" x 30' x 5/8" Lineset (Twin-Tube Insulation)††	MPLS385812T-30
	50' x 3/8" x 50' x 5/8" Lineset (Twin-Tube Insulation)††	MPLS385812T-50
	65' x 3/8" x 65' x 5/8" Lineset (Twin-Tube Insulation)††	MPLS385812T-65
Shutter Plate	Shutter Plate	PAC-SJ37SP-E
Space Panel	Architectural Surround for Ceiling Recessed Units	PLFY-ITP1
	Space Panel	PAC-SJ38AS-E

**NOTES:**

†PAC-SF40RM-E (Unable to use with wireless remote controller)

## OUTDOOR UNIT ACCESSORIES: PUZ-HA30NKA

Air Outlet Guide	Air Outlet Guide (1 Piece)	PAC-SH96SG-E (two pieces are required)
Centralized Drain Pan	Central Drain Pan	PAC-SH97DP-E
Control/Service Tool	Control/Service Tool	PAC-SK52ST
Drain Socket	Drain Socket	PAC-SG61DS-E
Hail Guards	Hail Guard	HG-A2
M-NET Converter	M-NET Converter	PAC-SJ85MA-E
	M-NET Converter	PAC-SJ95MA-E
Mounting Pad	Condensing Unit Mounting Pad: 24" x 42" x 3"	ULTRILITE2
Optional Defrost Heater	Optional Defrost Heater	PAC-SJ20BH-E
Stand	18" Dual Fan Stand	QSMS1802M
	24" Dual Fan Stand	QSMS2402M
	Condenser Wall Bracket	QSWB2000M-1
	Condenser Wall Bracket -Stainless Steel Finish	QSWBSS
	Outdoor Unit Stand — 12" High	QSMS1202M
Wind Baffle	Front Wind Baffle	WB-PA3 (two pieces are required)

# INDOOR UNIT DIMENSIONS: PLA-A30EA7

Unit: inch (mm)

- 1) CHOOSE THE GRILLE AMONG THE DESIGNATED GRILLES.
- 2) REINFORCE THE SUSPENSION BOLT FOR EARTHQUAKE-RESISTANCE AS NEEDED.
- 3) PROCEED AT THE LOCAL SITE.
- 4) FOR DRAIN PIPE, USE W-240D, H-14(T), 20(PVC TUBE).
- 5) DRAIN IS MADE AS A DRAIN FROM THE CEILING.
- 6) ELECTRICAL BOX MAY BE REMOVED FOR THE SERVICE PURPOSE.
- 7) HEIGHT OF THE INDOOR UNIT IS ABLE TO BE ADJUSTED.
- 8) WHEN INSTALLING THE BRANCH DUCTS, BE SURE TO INSULATE ADEQUATELY.
- 9) AS FOR NECESSARY INSTALLATION SERVICE SPACE, PLEASE REFER TO THE MULTI-FUNCTIONAL CASEMENT REFER TO SPECIAL DRAWING.

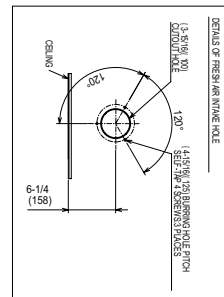
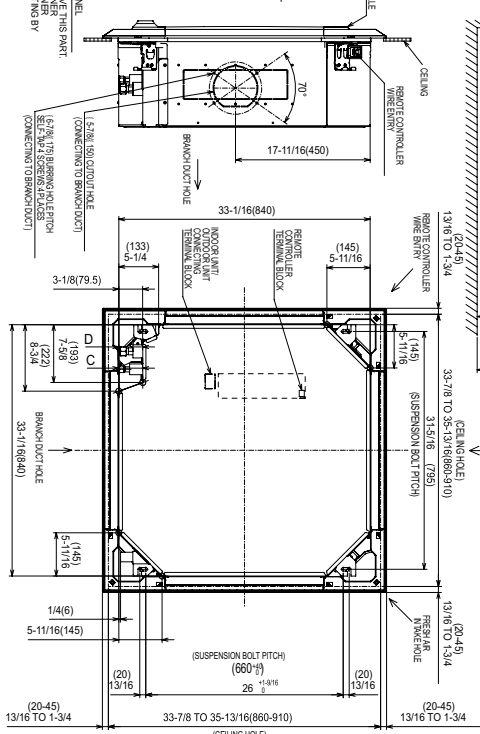
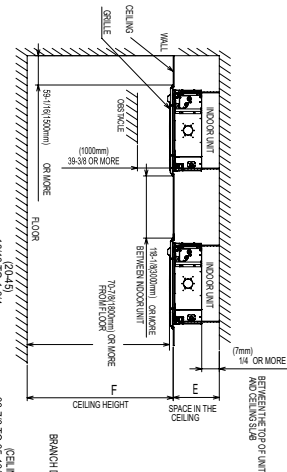
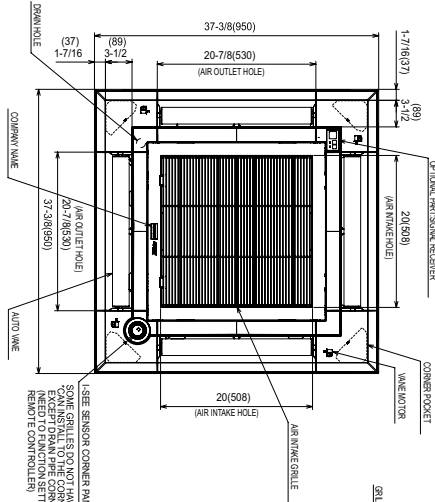

MODELS	①	②	A	B	C	D	E	F
20186TUH	REFRESH AIR PREHEAT TYPE CONNECTION UNIT	REFRESH AIR PREHEAT TYPE CONNECTION UNIT	5-1/2 (140)	10-3/8 (269)	3-7/8 (98.5)	3-7/8 (98.5)	10-1/2 (267)	10-1/2 (267)
2402034C4TUH	REFRESH AIR PREHEAT TYPE CONNECTION UNIT	REFRESH AIR PREHEAT TYPE CONNECTION UNIT	5-1/2 (140)	10-3/8 (269)	3-7/8 (98.5)	3-7/8 (98.5)	10-1/2 (267)	10-1/2 (267)

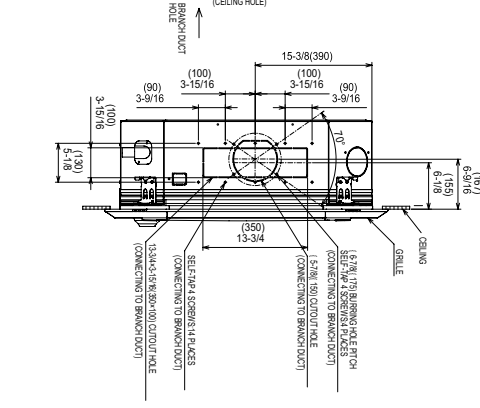
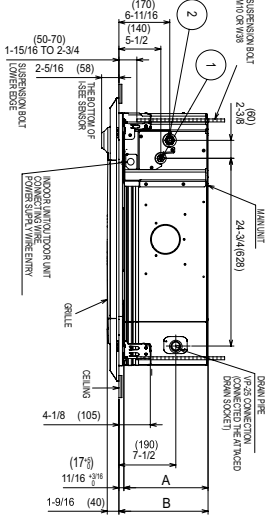
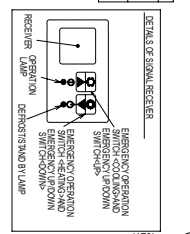

# OUTDOOR UNIT DIMENSIONS: PUZ-HA30NKA

Unit: mm<in>

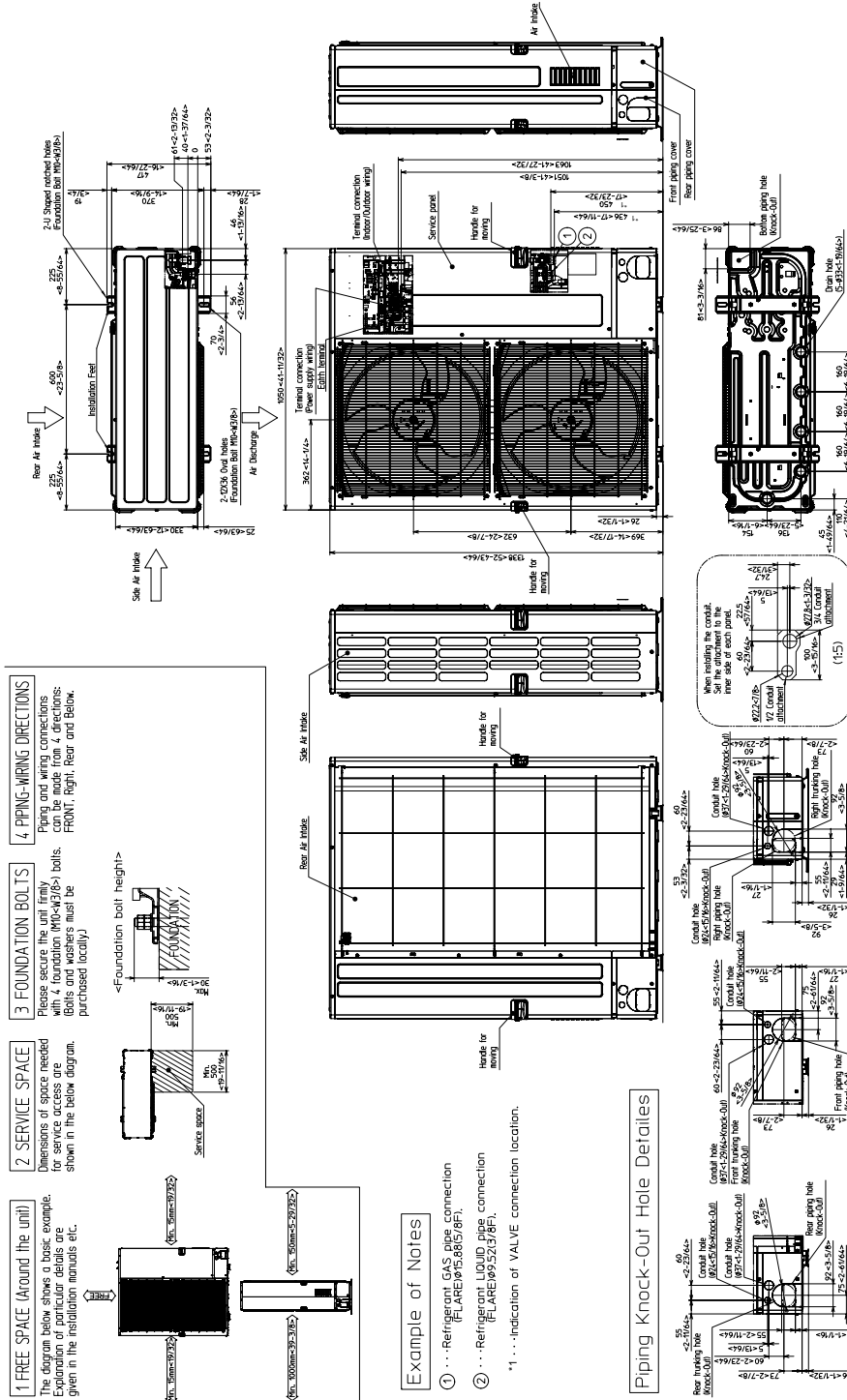

1340 Satellite Boulevard Suwanee, GA 30024  
Toll Free: 800-433-4822 www.mehvac.com

