

PVA-A30AA7 & PUZ-A30NHA7(-BS)
30,000 BTU/H HEAT PUMP UNIVERSAL OUTDOOR
30,000 BTU/H MULTI-POSITION AIR HANDLER



Job Name:

System Reference:

Date:

Indoor Unit.....PVA-A30AA7

Outdoor Unit

Standard Model.....PUZ-A30NHA7

Seacoast Model.....PUZ-A30NHA7-BS



INDOOR UNIT FEATURES

- Ducted air handler provides a solution to cool and heat large zones
- Highly efficient totally enclosed ECM motor
- Selectable external static pressure: 0.30, 0.50 and 0.80 in.WG with 3 fan speeds at each static setting
- 1 inch R4.2 fiberglass free insulation reduces condensation and boosts efficiency
- Positive pressure cabinet with air leakage of less than 1.0% at 1.0 in.WG
- Unique blow through design allows simple coil cleaning when the blower is removed
- Multi-position installation: horizontal (left or right), vertical (up or down). For downflow configurations, the CMA-1 is recommended for proper management of condensate to prevent water blow-off in certain conditions
- Optional electric heat kit for additional heat capacity
- Optional humidifier control and ERV control
- Multiple control options available:
 - kumo cloud® smart device app for remote access
 - Third-party interface options
 - Wired or wireless controllers

OUTDOOR UNIT FEATURES

- Variable speed INVERTER-driven compressor
- Power receiver pre-charged with refrigerant volume for piping length up to 70 ft
- Low ambient cooling down to 0°F providing 100% capacity
- 24-hour continuous operation (cooling mode)
- High pressure protection
- Fast restart
- Superior energy and operational efficiency

SPECIFICATIONS: PVA-A30AA7 & PUZ-A30NHA7(-BS)

Cooling at 95°F ¹	Maximum Capacity	BTU/H	30,000
	Rated Capacity	BTU/H	30,000
	Minimum Capacity	BTU/H	10,000
	Maximum Power Input	W	3,000
	Rated Power Input	W	3,000
	Moisture Removal	Pints/h	5.4
	Sensible Heat Factor		0.74
Heating at 47°F ²	Maximum Capacity	BTU/H	34,000
	Rated Capacity	BTU/H	32,000
	Minimum Capacity	BTU/H	12,000
	Maximum Power Input	W	2,820
	Rated Power Input	W	2,640
	Power Factor	%	96.8/96.8
Heating at 17°F ³	Maximum Capacity	BTU/H	20,700
	Rated Capacity	BTU/H	18,000
	Maximum Power Input	W	2,230
	Rated Power Input	W	2,110
Heating at 5°F ⁴	Maximum Capacity	BTU/H	17,200
	Maximum Power Input	W	2,000
Efficiency	SEER		19.0
	EER ¹		10.0
	HSPF [IV]		10.0
	COP at 47°F ²		3.54
	COP at 17°F at Maximum Capacity ³		2.73
	COP at 5°F at Maximum Capacity ⁴		2.52
Electrical	ENERGY STAR® Certified		No
	Voltage, Phase, Frequency		208/230, 1, 60
	Guaranteed Voltage Range	V AC	198 - 253
	Voltage: Indoor - Outdoor, S1-S2	V AC	208/230
	Voltage: Indoor - Outdoor, S2-S3	V DC	24
	Short-circuit Current Rating [SCCR]	kA	5
	Recommended Fuse/Breaker Size (Outdoor)	A	25
	Recommended Wire Size [Indoor - Outdoor]	AWG	14
Indoor Unit	Power Supply		Indoor unit is powered by the outdoor unit
	MCA	A	4.13
	Fan Motor Full Load Amperage	A	3.3
	Fan Motor Output	W	121
	Fan Motor Type		DC Motor
	Airflow Rate at Cooling, Dry	CFM	613-744-875
	Airflow Rate at Heating, Dry	CFM	613-744-875
	Sound Pressure Level [Cooling]	dB[A]	30-34-38
	Sound Pressure Level [Heating]	dB[A]	30-34-38
	External Static Pressure	in.WG	0.30-0.5-0.8
	Drain Pipe Size	In. [mm]	3/4 FPT [19.05]
	Coating on Heat Exchanger		—
	External Finish Color		Galvanized steel cabinet-Powder coated Slate Gray
	Unit Dimensions	W x D x H: In. [mm]	21 x 21-5/8 x 54-1/4 [534 x 548 x 1378]
Package Dimensions	W x D x H: In. [mm]	13-7/16 x 34-11/16 x 53-3/16 [340 x 880 x 1,350]	
Unit Weight	Lbs. [kg]	141 [64]	
Indoor Unit Operating Temperature Range	Cooling Intake Air Temp [Maximum / Minimum]*	°F	90 DB, 72 WB / 66 DB, 61 WB
	Heating Intake Air Temp [Maximum / Minimum]	°F	77 DB / 59 DB

NOTES:

AHRI Rated Conditions	¹ Cooling (Indoor // Outdoor)	°F	80 DB, 67 WB // 95 DB, 75 WB
(Rated data is determined at a fixed compressor speed)	² Heating at 47°F (Indoor // Outdoor)	°F	70 DB, 60 WB // 47 DB, 43 WB
	³ Heating at 17°F (Indoor // Outdoor)	°F	70 DB, 60 WB // 17 DB, 15 WB
Conditions	⁴ Heating at 5°F (Indoor // Outdoor)	°F	70 DB, 60 WB // 5 DB, 4 WB
	⁵ Heating at -4°F (Indoor // Outdoor)	°F	70 DB, 60 WB // -4 DB, -5 WB
	⁶ Heating at -5°F (Indoor // Outdoor)	°F	70 DB, 60 WB // -5 DB, -6 WB
	⁷ Heating at -13°F (Indoor // Outdoor)	°F	70 DB, 60 WB // -13 DB, -14 WB

*Outdoor Unit Operating Temperature Range (Cooling Air Temp (Maximum / Minimum)):

- Wind baffles required to operate below 23°F DB in cooling mode.
- Heat pump system with wind baffle: 0°F - 115°F.
- Refer to wind baffle documentation for further information.

**Outdoor Unit Operating Temperature Range (Cooling Thermal Lock-out / Re-start Temperatures; Heating Thermal Lock-out / Re-start Temperatures):

- System cuts out in heating mode to avoid thermistor error and automatically restarts at these temperatures.

SEACOAST PROTECTION (-BS MODELS)

- External Outer Panel: Phosphate coating + Acrylic-Enamel coating
- Fan Motor Support: Epoxy resin coating (at edge face)
- Separator Assembly Valve Bed: Epoxy resin coating (at edge face)
- Blue Fin treatment is an anti-corrosion treatment that is applied to the condenser coil to protect it against airborne contaminants.

SPECIFICATIONS: PVA-A30AA7 & PUZ-A30NHA7(-BS)

Outdoor Unit	MCA	A	19.0
	MOCP	A	26
	Fan Motor Full Load Amperage	A	0.4
	Fan Motor Output	W	86
	Airflow Rate	CFM	1940/1940
	Refrigerant Control		LEV
	Defrost Method		Reverse Cycle
	Coating on Heat Exchanger		Blue Fin Coating (BS Model only)
	Sound Pressure Level, Cooling ¹	dB(A)	47
	Sound Pressure Level, Heating ²	dB(A)	48
	Compressor Type		INVERTER-driven twin rotary
	Compressor Model		SNB172FVHM1
	Compressor Rated Load Amps	A	7
	Compressor Locked Rotor Amps	A	11.0
	Compressor Oil Type // Charge	oz.	FV50S // 23
	External Finish Color		Ivory Munsell 3Y 7.8/1.1
	Base Pan Heater		N/A
	Unit Dimensions	W x D x H: In. [mm]	37-13/32 x 13 (+1-3/16) x 37-1/8 [950 x 330 (+30) x 943]
	Package Dimensions	W x D x H: In. [mm]	40-15/16 x 17-11/16 x 40-11/16 [1040 x 450 x 1033]
	Unit Weight	Lbs. [kg]	153 [69]
Package Weight	Lbs. [kg]	179 [81]	
Outdoor Unit Operating Temperature Range	Cooling Air Temp [Maximum / Minimum]*	°F	115 DB / 0 DB
	Heating Air Temp [Maximum / Minimum]	°F	70 DB, 59 WB / -4 DB, -4 WB
	Heating Thermal Lock-out / Re-start Temperatures**	°F	-8 / -4
Refrigerant	Type		R410A
	Charge	Lbs, oz	7, 11.0
	Chargeless Piping Length	Ft. [m]	70.0 [20.0]
	Additional Refrigerant Charge Per Additional Piping Length	oz./Ft. [g/m]	0.7 [50]
Piping	Gas Pipe Size O.D. [Flared]	In.[mm]	5/8 [15.88]
	Liquid Pipe Size O.D. [Flared]	In.[mm]	3/8 [9.52]
	Maximum Piping Length	Ft. [m]	165 [50]
	Maximum Height Difference	Ft. [m]	100 [30]
	Maximum Number of Bends		15

NOTES:

AHRI Rated Conditions
 (Rated data is determined at a fixed compressor speed)

¹ Cooling (Indoor // Outdoor)	°F	80 DB, 67 WB // 95 DB, 75 WB
² Heating at 47°F (Indoor // Outdoor)	°F	70 DB, 60 WB // 47 DB, 43 WB
³ Heating at 17°F (Indoor // Outdoor)	°F	70 DB, 60 WB // 17 DB, 15 WB

Conditions

⁴ Heating at 5°F (Indoor // Outdoor)	°F	70 DB, 60 WB // 5 DB, 4 WB
⁵ Heating at -4°F (Indoor // Outdoor)	°F	70 DB, 60 WB // -4 DB, -5 WB
⁶ Heating at -5°F (Indoor // Outdoor)	°F	70 DB, 60 WB // -5 DB, -6 WB
⁷ Heating at -13°F (Indoor // Outdoor)	°F	70 DB, 60 WB // -13 DB, -14 WB

*Outdoor Unit Operating Temperature Range (Cooling Air Temp (Maximum / Minimum)):

- Wind baffles required to operate below 23°F DB in cooling mode.
- Heat pump system with wind baffle: 0°F - 115°F.
- Refer to wind baffle documentation for further information.

**Outdoor Unit Operating Temperature Range (Cooling Thermal Lock-out / Re-start Temperatures; Heating Thermal Lock-out / Re-start Temperatures):

- System cuts out in heating mode to avoid thermistor error and automatically restarts at these temperatures.

SEACOAST PROTECTION (-BS MODELS)

- External Outer Panel: Phosphate coating + Acrylic-Enamel coating
- Fan Motor Support: Epoxy resin coating (at edge face)
- Separator Assembly Valve Bed: Epoxy resin coating (at edge face)
- Blue Fin treatment is an anti-corrosion treatment that is applied to the condenser coil to protect it against airborne contaminants.

INDOOR UNIT ACCESSORIES: PVA-A30AA7

Control Interface	3-Pin Connector	PAC-715AD
	BACnet® and Modbus® Interface	PAC-UKPRC001-CN-1
	CN24 Relay Kit	CN24RELAY-KIT-CM3
	Connector cable for remote display	PAC-SA88HA-EP
	IT Extender	PAC-WHS01IE-E
	kumo station® for kumo cloud®	PAC-WHS01HC-E
	Lockdown bracket for remote controller	RCMKP1CB
	Remote Operation Adapter†	PAC-SF40RM-E
	Thermostat Interface	PAC-US444CN-1
	USNAP Adapter	PAC-WHS01UP-E
Remote Sensor	Flush Mount Temperature Sensor	PAC-USSEN001-FM-1
	Remote Temperature Sensor	PAC-SE41TS-E
	Wireless temperature and humidity sensor for kumo cloud®	PAC-USWHS003-TH-1
Wired Remote Controller	Airzone ZBS Wired Blueface Principal Controller White	AZZBSBLUEFACECB
	Airzone ZBS Wired Lite Controller White	AZZBSLITECB
	Airzone ZBS Wired Think Controller White	AZZBSTHINKCB
	Airzone ZBS Wireless Lite Controller White	AZZBSLITERB
	Airzone ZBS Wireless Think Controller White	AZZBSTHINKRB
	Deluxe Wired MA Remote Controller†	PAR-40MAAU
	Simple MA Remote Controller†	PAC-YT53CRAU-J
	Touch MA Controller†	PAR-CT01MAU-SB
Wireless Remote Controller	kumo touch™ RedLINK™ Wireless Controller	MHK2
	Wireless MA Controller	PAR-FA32MA-W
	Wireless MA Remote Controller	PAR-FL32MA-E
	Wireless Remote Controller	PAR-SL100A-E
	Wireless Remote Controller	PAR-SL101A-E
Condensate	Blue Diamond Sensor Extension Cable — 15 Ft.	C13-103
Control Wire	20/2PR, 1PR shielded + 1PR plenum wire for Airzone, 100 ft reel	CW2042S2-100
	20/2PR, shielded + 1PR plenum wire for Airzone, 500 ft reel	CW2042S2-500
Disconnect Switch	(30A/600V/UL) [fits 2" X 4" utility box] - Black	TAZ-MS303
	(30A/600V/UL) [fits 2" X 4" utility box] - White	TAZ-MS303W
Downflow Kit	Condensate Management Kit for downflow installation	CMA-1
Electric Heat Lockout	Electric Heat Lockout	ETC-211000-MIT
Electric Kit Heats	3kW Electric Heater	EH03-MPA-MB
	5kW Electric Heater	EH05-MPA-MB
	8kW Electric Heater	EH08-MPA-MB
Lineset	10' x 3/8" x 10' x 5/8" Lineset (Twin-Tube Insulation)††	MPLS385812T-10
	100' x 3/8" x 100' x 5/8" Lineset (Twin-Tube Insulation)††	MPLS385812T-100
	15' x 3/8" x 15' x 5/8" Lineset (Twin-Tube Insulation)††	MPLS385812T-15
	30' x 3/8" x 30' x 5/8" Lineset (Twin-Tube Insulation)††	MPLS385812T-30
	50' x 3/8" x 50' x 5/8" Lineset (Twin-Tube Insulation)††	MPLS385812T-50
	65' x 3/8" x 65' x 5/8" Lineset (Twin-Tube Insulation)††	MPLS385812T-65
Terminal Block	Separate Terminal Power Block	SPTB1

NOTES:

†PAC-SF40RM-E (Unable to use with wireless remote controller)

OUTDOOR UNIT ACCESSORIES: PUZ-A30NHA7(-BS)

Air Outlet Guide	Air Outlet Guide (1 Piece)	PAC-SG59SG-E
Centralized Drain Pan	Centralized Drain Pan	PAC-SG63DP-E
	Drain Pan	PAC-SG64DP-E
Control/Service Tool	Control/Service Tool	PAC-SK52ST
	M- & P-Series Maintenance Tool Cable Set	M21EC0397
	USB/UART Conversion Cable (Required for all laptop connection)	M21EC1397
Drain Socket	Drain Socket	PAC-SG61DS-E
Hail Guards	Hail Guard	HG-A6
M-NET Converter	M-NET Converter	PAC-SJ85MA-E
	M-NET Converter	PAC-SJ95MA-E
Mini-Split Wire	14 Gauge, 4 wire MiniSplit Cable—250 ft. roll	S144-250
	14 Gauge, 4 wire MiniSplit Cable—50 ft. roll	S144-50
	16 Gauge, 4 wire MiniSplit Cable—250 ft. roll	S164-250
	16 Gauge, 4 wire MiniSplit Cable—50 ft. roll	S164-50
Mounting Pad	Condensing Unit Mounting Pad: 24" x 42" x 3"	ULTRILITE2
Stand	18" Single Fan Stand	QSMS1801M
	24" Single Fan Stand	QSMS2401M
	Condenser Wall Bracket -Stainless Steel Finish	QSWBSS
	Designed for M-Series, S-Series, P-Series and CITY MULTI® PUMY Outdoor Units	QSWB2000M-1
	Outdoor Unit Stand — 12" High	QSMS1201M
Wind Baffle	Front Wind Baffle	WB-PA5
	Rear Wind Baffle	WB-RE5
	Side Advanced Wind Baffle	WB-SD5

INDOOR UNIT DIMENSIONS: PVA-A30AA7

Unit:mm(in.)

Note 1.Keep the service space for maintenance at the front.

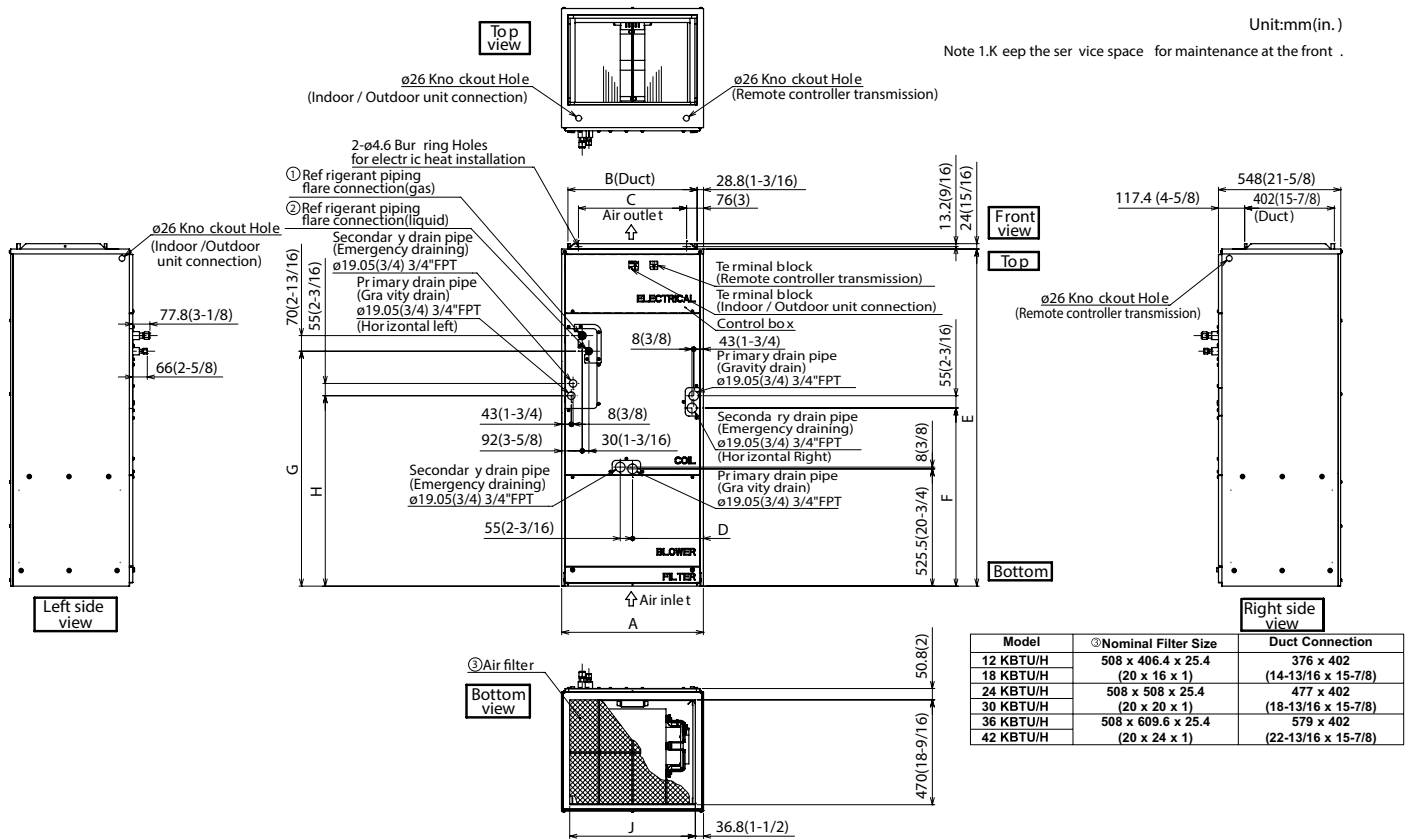

Model	①Nominal Filter Size	Duct Connection
12 KBTU/H	508 x 406.4 x 25.4	376 x 402
18 KBTU/H	(20 x 16 x 1)	(14-13/16 x 15-7/8)
24 KBTU/H	508 x 508 x 25.4	477 x 402
30 KBTU/H	(20 x 20 x 1)	(18-13/16 x 15-7/8)
36 KBTU/H	508 x 609.6 x 25.4	579 x 402
42 KBTU/H	(20 x 24 x 1)	(22-13/16 x 15-7/8)

Model	A	B	C	D	E	F	G	H	J	Unit: mm (in.)	
										①Gas Pipe	②Liquid Pipe
12 KBTU/H	432 (17)	376 (14-13/16)	281 (11-1/8)	224 (8-7/8)	1275 (50-1/4)	680 (26-13/16)	823 (32-7/16)	735.5 (29)	360 (14-3/16)	Φ 12.7 (1/2)	Φ 6.35 (1/4)
18 KBTU/H											
24 KBTU/H	534 (21)	477 (18-13/16)	382.6 (15-1/8)	266.5 (10-1/2)	1378 (54-1/4)	737 (29-1/16)	953.5 (37-9/16)	792 (31-3/16)	461 (18-3/16)	Φ 15.88 (5/8)	Φ 9.52 (3/8)
30 KBTU/H											
36 KBTU/H	635 (25)	579 (22-13/16)	484.6 (19-1/8)	317.5 (12-1/2)	1511 (59-1/2)	798.5 (31-7/16)	1053 (41-1/2)	853.5 (33-5/8)	563 (22-3/16)		
42 KBTU/H											

OUTDOOR UNIT DIMENSIONS: PUZ-A30NHA7(-BS)

Unit: mm<in>

1 FREE SPACE (Around the unit)

The diagram below shows a basic example. Explanation of particular details are given in the installation manuals etc.

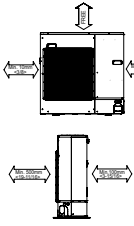

2 SERVICE SPACE

Dimensions of space needed for service access are shown in the below diagram.

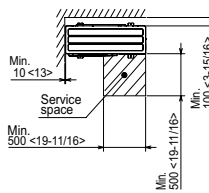

3 FOUNDATION BOLTS

Please secure the unit firmly with 4 foundation (M10<W3/8>) bolts. (Bolts and washers must be purchased locally.)

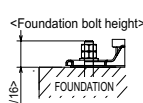

4 PIPING-WIRING DIRECTIONS

Piping and wiring connections can be made from 4 directions: FRONT, Right, Rear and Below.

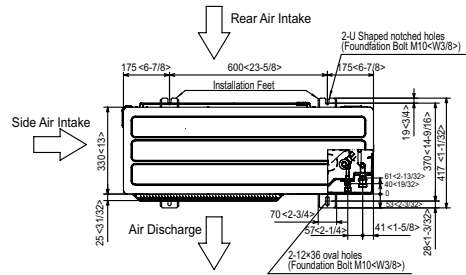

Example of Notes

- ① ... Refrigerant GAS pipe connection (FLARE) ø15.88(5/8F)
- ② ... Refrigerant LIQUID pipe connection (FLARE) ø9.52(3/8F)
- *1... Indication of STOP VALVE connection location.

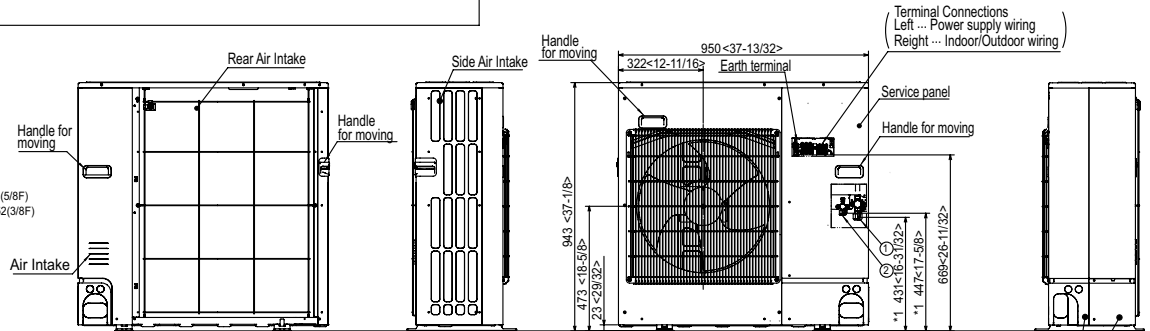

Piping knockout Hole Details

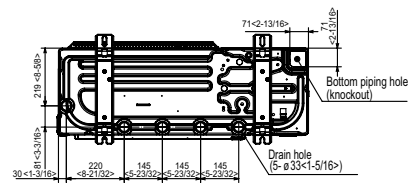
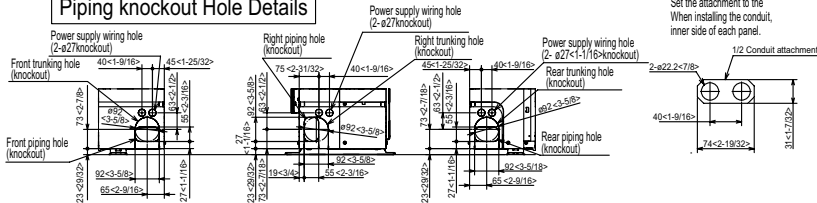

1340 Satellite Boulevard Suwanee, GA 30024
Toll Free: 800-433-4822 www.mehvac.com



FORM# PVA-A30AA7 & PUZ-A30NHA7(-BS) - 202110