



SUBMITTAL

Project Name:		Project Location:	
Quote ID:		Item #:	1000
Submitted For:		Submitted On:	
Submitted By:		Submitted From:	
Identity #:		Tag:	

For Record
 For Approval
 By: _____
 Date: _____

General Product Information

Product Family:	LEL	Motor type	2 SPEED EC
Defrost Type:	Electric	Number of Fans:	2
Voltage: (Volts/Ph/Hz)	208-230/1/60	Fan HorsePower	1/20
Refrigerant Type:	R404A	Fins per Inch	6

Technical Information

Performance Data

Capacity			Air Flow				Altitude (ft)	AWEF Value
TD (°F)	SST (°F)	Capacity (BTU/H)	CFM	Fan Diameter (ft)	Air Throw (ft)			
					Standard	w/Collar		
10	-20.0	6,250	1,371	12			0	N/A

Electrical Data

Fan Motor(s)		Defrost Heater(s)		Drain Pan Heater(s)	
Watts	Amps	Watts	Amps	Watts	Amps
110	1	2,100	9.1		

Unit Specifications

Connections (in.)						Approx. Net Weight (lbs)
Coil Inlet	Suction	External Equalizer	Drain	Side Port	Hot Gas Drain Pan	
1/2	5/8	1/4	3/4			54

Dimensional Drawing(s)

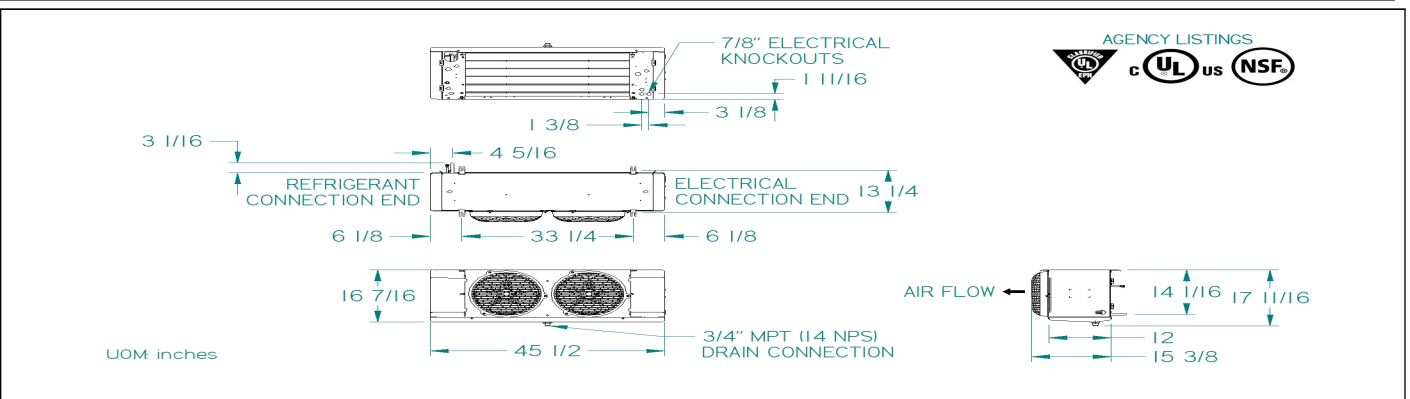



SUBMITTAL

Project Name:		Project Location:	
Quote ID:		Item #:	1000
Submitted For:		Submitted On:	
Submitted By:		Submitted From:	
Identity #:		Tag:	

Standard Features

EASE OF INSTALLATION SERVICE

- ALL ELECTRICAL COMPONENTS FACTORY WIRED TO TERMINAL BOARD AND IDENTIFIED, MAKING IT EASY TO FIELD WIRE THE UNIT
- CABINET DESIGN FEATURES HINGED, REMOVABLE FRONT ACCESS PANELS ON EACH SIDE FOR EASY ACCESS TO ELECTRICAL AND REFRIGERATION COMPONENTS
- LIQUID LINE SOLENOID WIRE HARNESS IS FACTORY-INSTALLED FOR QUICK INSTALLATION
- MOTORS PLUG INTO WIRING HARNESS FOR EASIER SERVICING
- HINGED, REMOVABLE DRAIN PAN FOR EASY AND SAFE ACCESS
- PRE-DRILLED HOLES ON THE BACK OF THE UNIT FOR ROOM THERMOSTAT
- QUICK REMOVAL FAN GUARD/MOTOR ASSEMBLY FOR EASY SERVICE OR REPLACEMENT OF AIR MOVER PARTS

RELIABLE DURABLE

- HEAVY GAUGE, WHITE PAINTED CABINET CLEANS EASILY AND LOOKS ATTRACTIVE
- MOLDED FAN GUARD AND ACCESS PANELS ARE MADE OF STRONG, DURABLE, AND NSF AND UL SANITATION RATED PLASTIC MATERIAL
- SWEAT CONNECTIONS TO REDUCE POTENTIAL FOR LEAKS

PERFORMANCE

- INTERNAL PANELS ARE ISOLATED FOR QUIET OPERATION
- INTERNALLY ENHANCED TUBING AND FIN DESIGN FOR HIGHER EFFICIENCY
- EC MOTORS STANDARD ON ALL MODELS FOR IMPROVED UNIT EFFICIENCY

VERSATILE

- LARGE DIAMETER DRAIN HOLE (3/4" ID) IS LOCATED TOWARDS THE BACK OF THE UNIT
- MINIMAL HEIGHT OF THE LOW PROFILE SERIES MAKES IT IDEAL FOR LOW CEILING COOLERS

Options

Mounted Options

- DOE Compliance - Does not meet DOE minimum AWEF requirement for WICF
- Motor - 2 Speed EC
- Defrost Type - Electric
- DTFD Option - Fixed
- Fan Guard - Molded
- Drain Pan Type - White
- Defrost Control - Fixed
- Insulated Drain Pan - NO
- Brand Label - LARKIN
- Voltage - 208-230/1/60
- Drain Pan Defrost Voltage - 208-230/1/60
- Fan Blade - Standard
- Cabinet Type - White
- Controller Option - None
- Fin Material - Aluminum
- Coil Mechanical Option - Standard

Minimum Unit Clearances

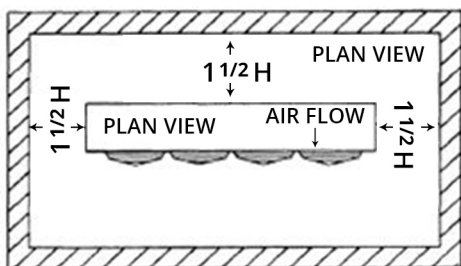

One Evaporator

NOTE:
H = Total Height evaporator coil surface.

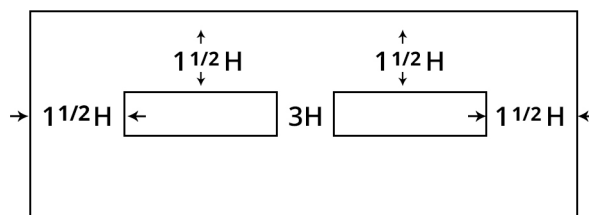

Two Evaporators