



SUBMITTAL

Project Name:		Project Location:	
Quote ID:		Item #:	1000
Submitted For:		Submitted On:	
Submitted By:		Submitted From:	
Identity #:		Tag:	

For Record
 For Approval
 By: _____
 Date: _____

General Product Information

Product Family:	LEL	Motor type	2 SPEED EC
Defrost Type:	Air	Number of Fans:	2
Voltage: (Volts/Ph/Hz)	115/1/60	Fan HorsePower	1/20
Refrigerant Type:	R404A	Fins per Inch	6

Technical Information

Performance Data

Capacity			Air Flow				Altitude (ft)	AWEF Value
TD (°F)	SST (°F)	Capacity (BTU/H)	CFM	Fan Diameter (ft)	Air Throw (ft)			
					Standard	w/Collar		
10	25.0	9,350	1,220	12			0	9

Electrical Data

Fan Motor(s)		Defrost Heater(s)		Drain Pan Heater(s)	
Watts	Amps	Watts	Amps	Watts	Amps
110	1.8				

Unit Specifications

Connections (in.)						Approx. Net Weight (lbs)
Coil Inlet	Suction	External Equalizer	Drain	Side Port	Hot Gas Drain Pan	
1/2	7/8	1/4	3/4			56

Dimensional Drawing(s)

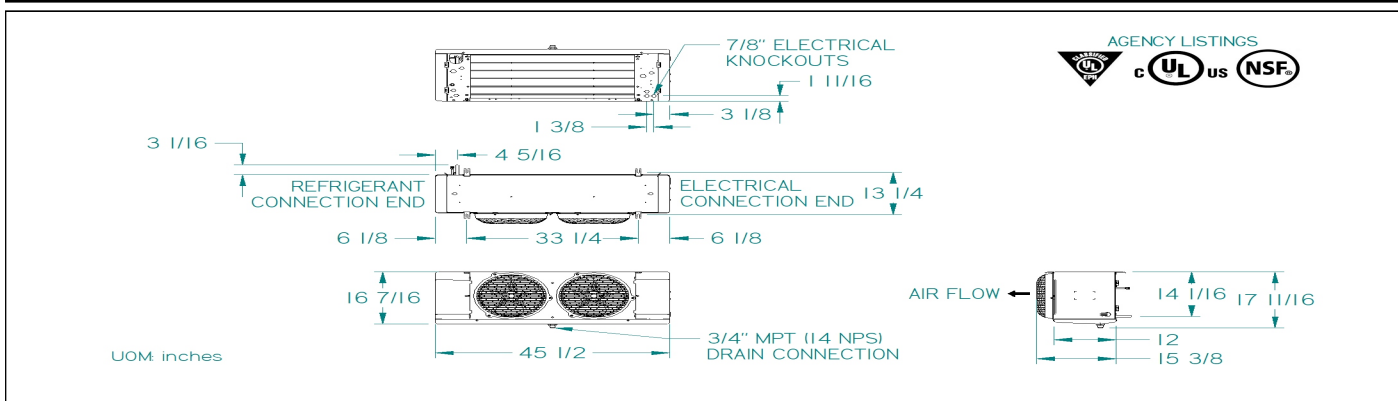



SUBMITTAL

Project Name:		Project Location:	
Quote ID:		Item #:	1000
Submitted For:		Submitted On:	
Submitted By:		Submitted From:	
Identity #:		Tag:	

Standard Features

EASE OF INSTALLATION SERVICE

- ALL ELECTRICAL COMPONENTS FACTORY WIRED TO TERMINAL BOARD AND IDENTIFIED, MAKING IT EASY TO FIELD WIRE THE UNIT
- CABINET DESIGN FEATURES HINGED, REMOVABLE FRONT ACCESS PANELS ON EACH SIDE FOR EASY ACCESS TO ELECTRICAL AND REFRIGERATION COMPONENTS
- LIQUID LINE SOLENOID WIRE HARNESS IS FACTORY-INSTALLED FOR QUICK INSTALLATION
- MOTORS PLUG INTO WIRING HARNESS FOR EASIER SERVICING
- HINGED, REMOVABLE DRAIN PAN FOR EASY AND SAFE ACCESS
- PRE-DRILLED HOLES ON THE BACK OF THE UNIT FOR ROOM THERMOSTAT
- QUICK REMOVAL FAN GUARD/MOTOR ASSEMBLY FOR EASY SERVICE OR REPLACEMENT OF AIR MOVER PARTS

RELIABLE DURABLE

- HEAVY GAUGE, WHITE PAINTED CABINET CLEANS EASILY AND LOOKS ATTRACTIVE
- MOLDED FAN GUARD AND ACCESS PANELS ARE MADE OF STRONG, DURABLE, AND NSF AND UL SANITATION RATED PLASTIC MATERIAL
- SWEAT CONNECTIONS TO REDUCE POTENTIAL FOR LEAKS

PERFORMANCE

- INTERNAL PANELS ARE ISOLATED FOR QUIET OPERATION
- INTERNALLY ENHANCED TUBING AND FIN DESIGN FOR HIGHER EFFICIENCY
- EC MOTORS STANDARD ON ALL MODELS FOR IMPROVED UNIT EFFICIENCY

VERSATILE

- LARGE DIAMETER DRAIN HOLE (3/4" ID) IS LOCATED TOWARDS THE BACK OF THE UNIT
- MINIMAL HEIGHT OF THE LOW PROFILE SERIES MAKES IT IDEAL FOR LOW CEILING COOLERS

Options

Mounted Options

- Brand Label - LARKIN
- Voltage - 115/1/60
- DTFD Option - None
- Fan Guard - Molded
- Drain Pan Type - White
- Defrost Control - None
- Insulated Drain Pan - NO
- Motor - 2 Speed EC
- Defrost Type - Air
- Fan Blade - Standard
- Cabinet Type - White
- Controller Option - None
- Fin Material - Aluminum
- Coil Mechanical Option - Standard

Minimum Unit Clearances

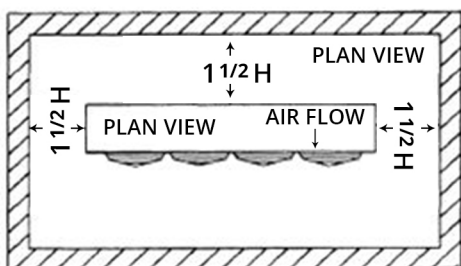

One Evaporator

NOTE:
H = Total Height evaporator coil surface.

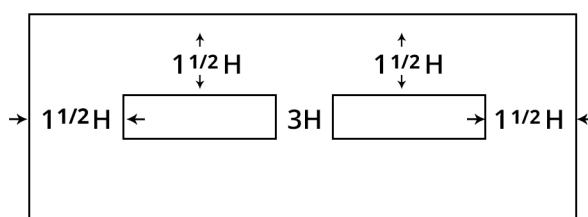

Two Evaporators